

# ASSEMBLY INSTRUCTIONS

## Style #V1513 Valet

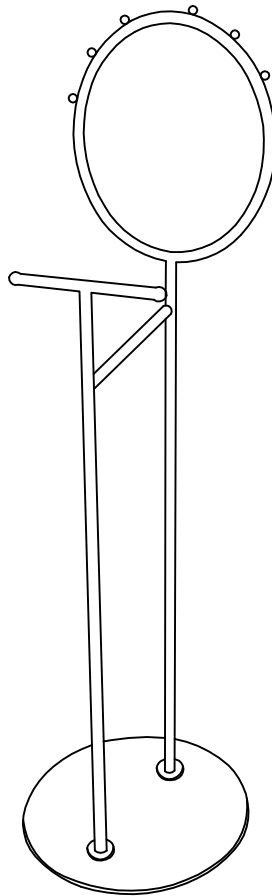



### NOTE TO CUSTOMERS:

- For ease and speed of assembly we recommend that before you commence each step of the assembly that you identify all the parts required to complete that step.
- We recommend that where possible you allow sufficient space to assemble the item as close as possible to the place where it will be once assembled.
- For the protection of your furniture we recommend that the product is placed on protected surfaces during assembly to prevent any damage.
- During assembly do not over tighten, as this may damage the product.
- Please ensure you retain all the product packaging until the item completely assembled.
- Please periodically check all fittings and re-tighten as necessary.
- It is recommended that this item should be assembled by two adults.

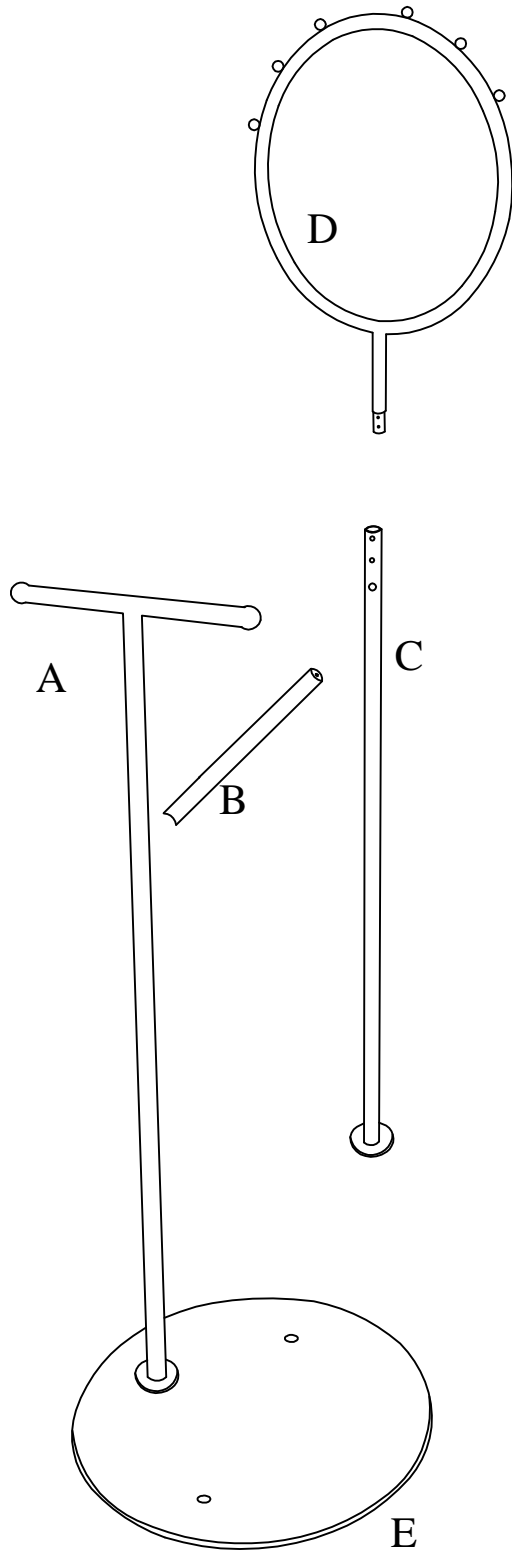

# Part List

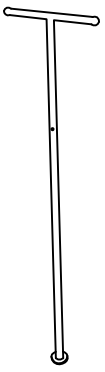

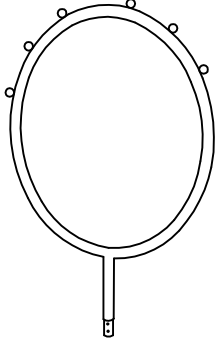
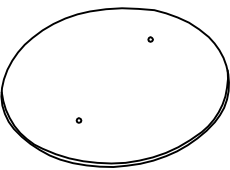
## Part List

<b>A</b>  1PC Font Pole	<b>B</b>  1PC Connect Bar	<b>C</b>  1PC Rear Pole	<b>D</b>  1PC Hook
<b>E</b>  1PC Base			

## Hardware List

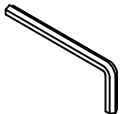
<b>①</b>  4PCS Bolt	<b>②</b>  2PCS Screw	 Allen Key	
---	--	---	--

### STEP 1

### Assembly instructions

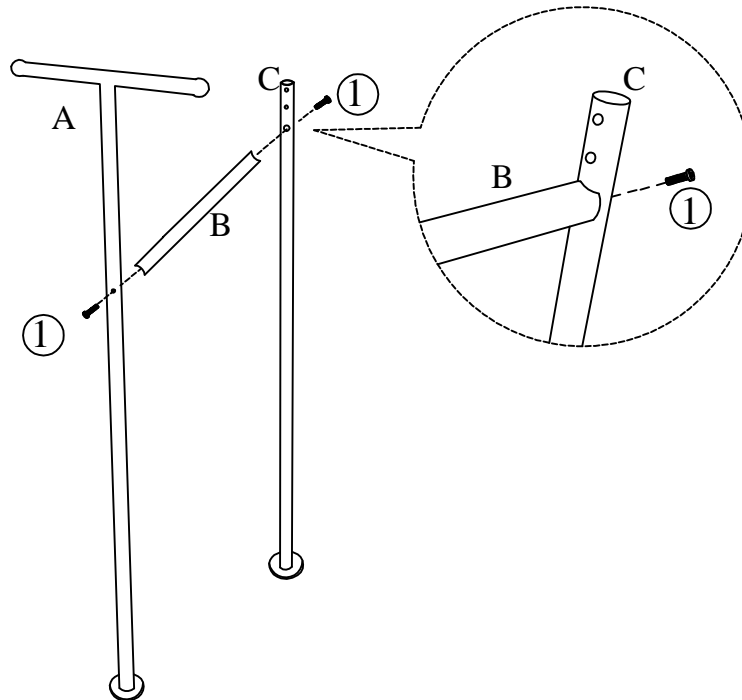
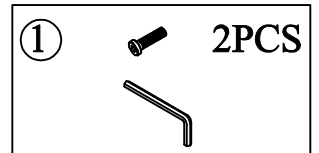

Assemble Connect Bar (B) to Front Pole (A) & Rear Pole (C) using Bolts (1) as shown above. Do not tighten bolts until the last step.

## STEP 2

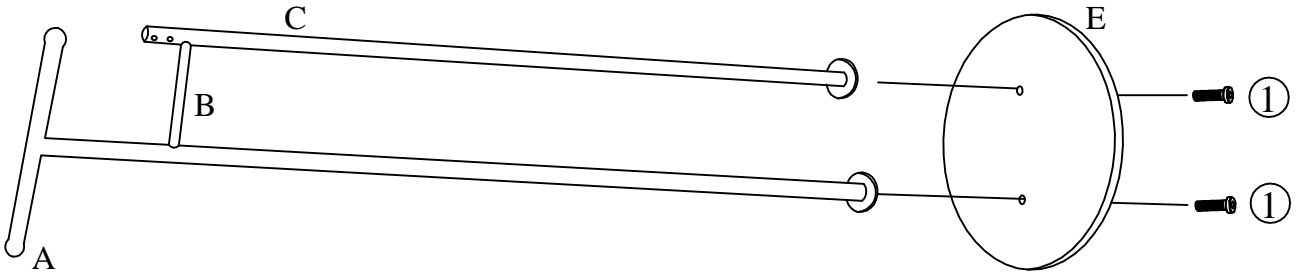
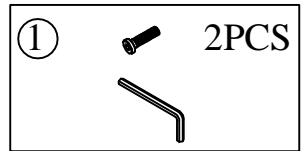

Assemble Front Pole (A) & Rear Pole (C) to Base (E) using Bolts (1) as shown above. Please tighten all bolts at this point.

## STEP 3

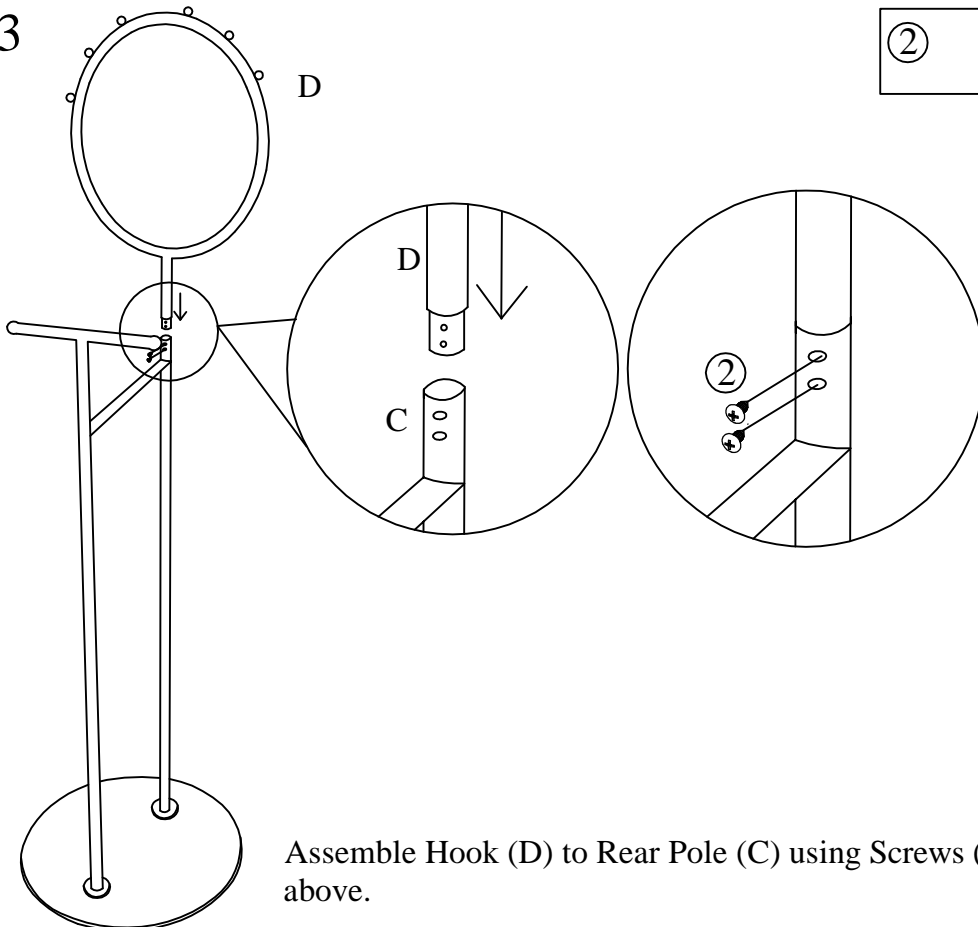

Assemble Hook (D) to Rear Pole (C) using Screws (2) as shown above.