

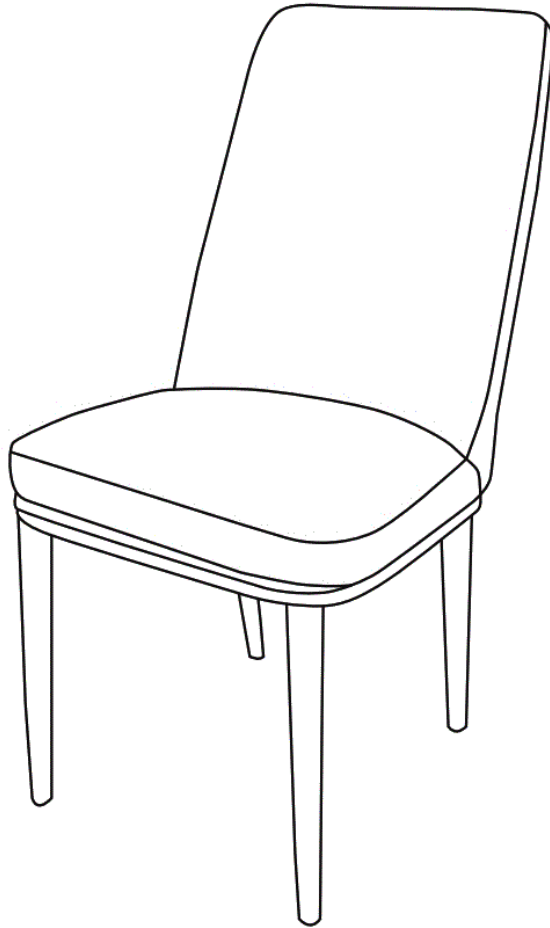





Assembly Instructions

Style # PC11-2 & PC11-4 Side Chair



NOTE TO CUSTOMERS:

- For ease and speed of assembly we recommend that before you commence each step of the assembly that you identify all the parts required to complete that step.
- We recommend that where possible you allow sufficient space to assemble the item as close as possible to the place where it will be once assembled.
- For the protection of your furniture we recommend that the product is placed on protected surfaces during assembly to prevent any damage.
- During assembly do not over tighten, as this may damage the product.
- Please ensure you retain all the product packaging until the item completely assembled.
- Please periodically check all fittings and re-tighten as necessary.
- Never allow any liquids to remain on your furniture as absorption can cause the surface to warp or the finish to de-laminate
- It is recommended that this item should be assembled by two adults.

1:Seat	1pc	2:Leg	1pc	A:Washer	4pcs	B:Bolt	4pcs	C:Allen Wrench
								

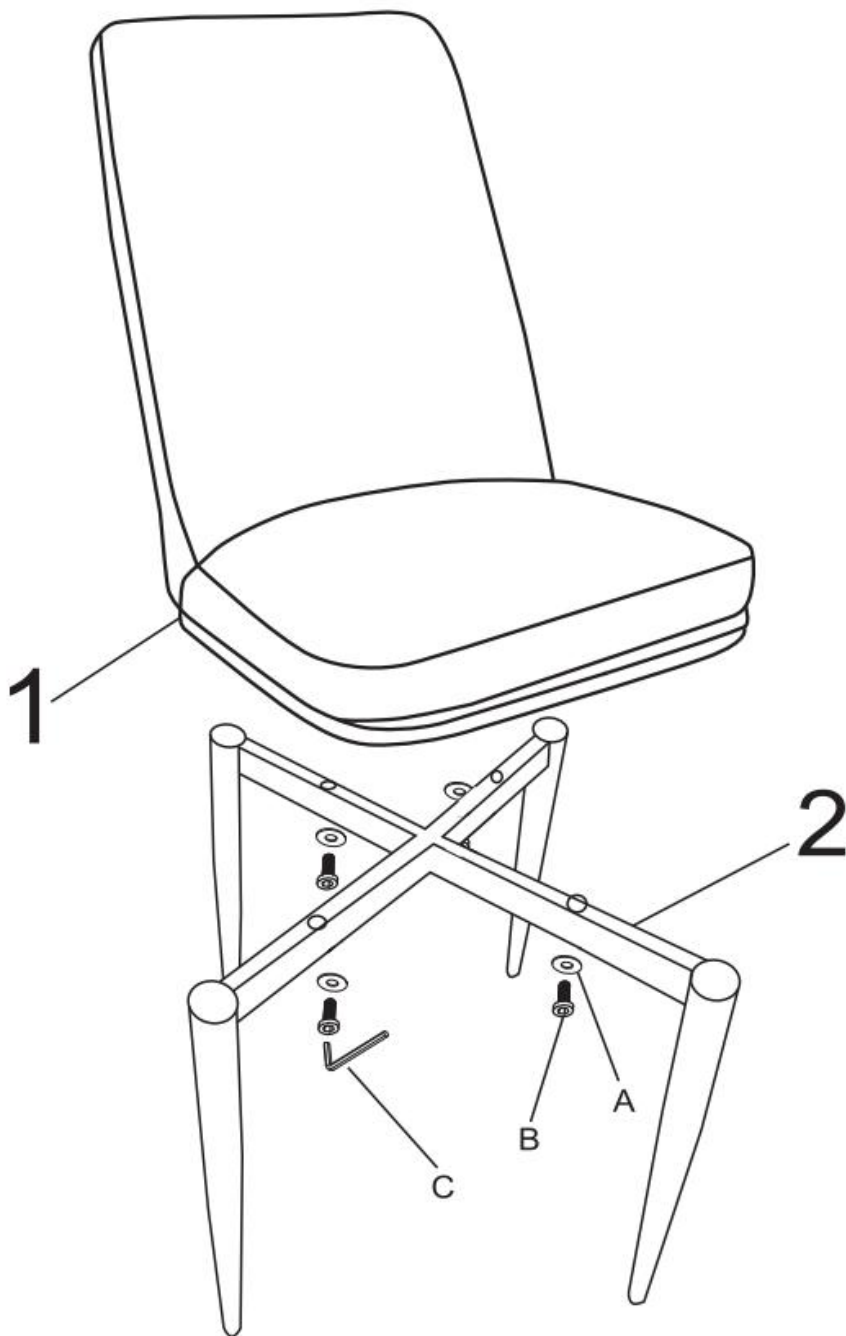

Do not tighten Bolts until all of them are attached.