

# Assembly instructions

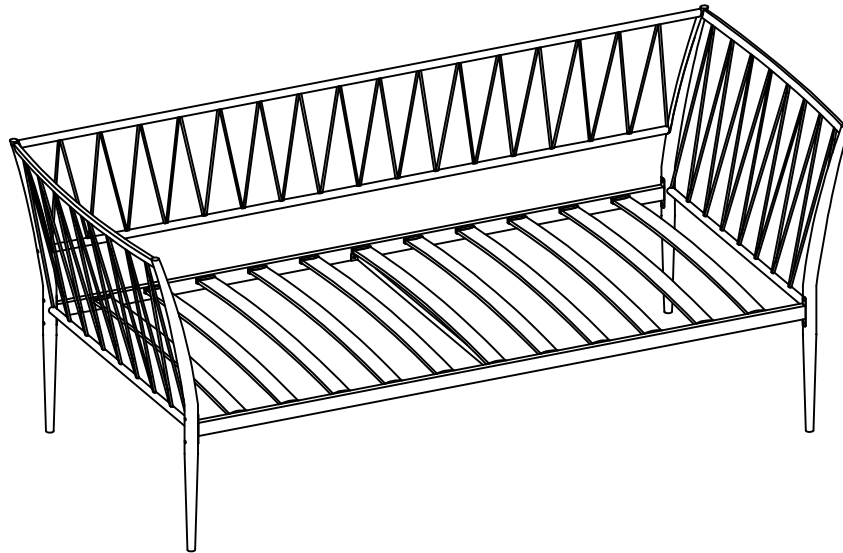



## Style#DB217 Day Bed





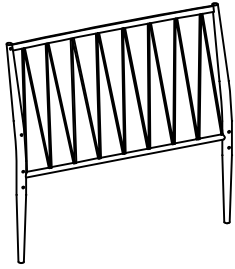
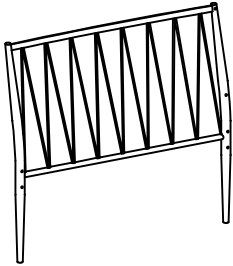
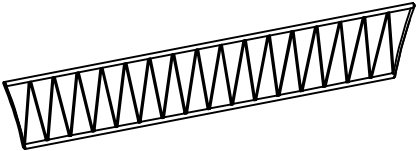

### NOTE TO CUSTOMERS:

- For ease and speed of assembly we recommend that before you commence each step of the assembly that you identify all the parts required to complete that step.
- We recommend that where possible you allow sufficient space to assemble the item as close as possible to the place where it will be once assembled.
- For the protection of your furniture we recommend that the product is placed on protected surfaces during assembly to prevent any damage.
- During assembly do not over tighten, as this may damage the product.
- Please ensure you retain all the product packaging until the item completely assembled.
- Please periodically check all fittings and re-tighten as necessary.
- It is recommended that this item should be assembled by two adults.

## A-Furniture Parts

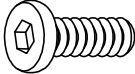
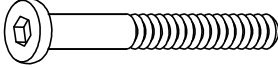
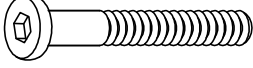
Parts ID	Image	Description	Qty
A		Headboard	1
B		Footboard	1
C		Backrest	1
D		Side Rail	2
E		Support Bar	1
F		Slat	11
G		Plastic Cap	22

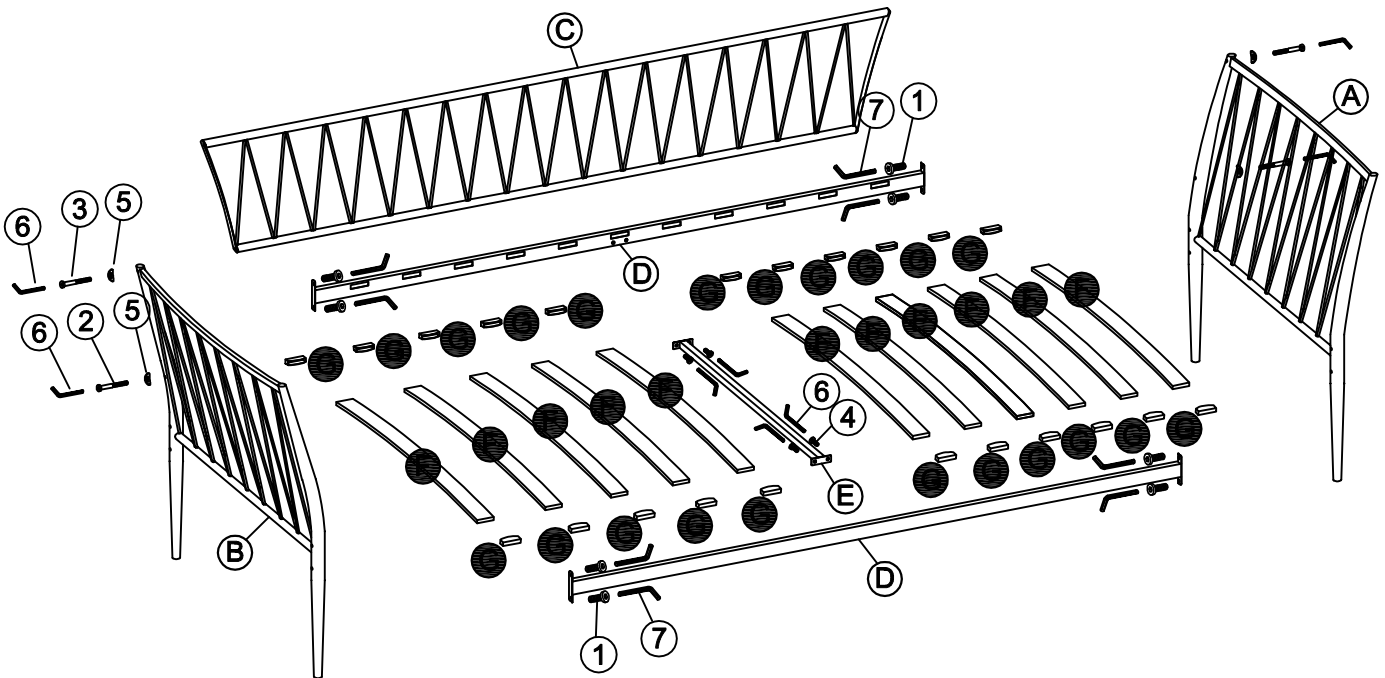

### B-Hardware Parts

Parts ID	Image	Description	Qty
1		Bolt 0.325"*0.75"L M8*20mm	8
2		Bolt 0.25"x2"L M6*50mm	2
3		Bolt 0.25"*1.5"L M6*40mm	2
4		Bolt 0.25"*0.625"L M6*16mm	4
5		Washer	4
6		4# Allen Key	1
7		5# Allen Key	1



# Assembly instructions



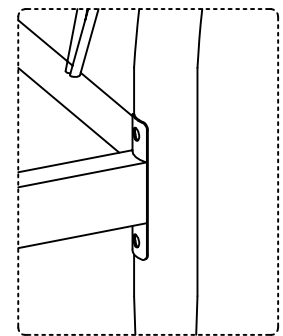
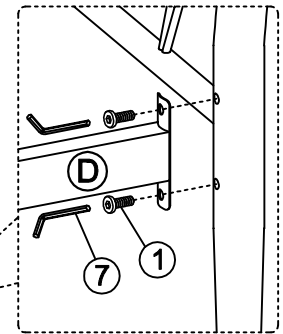
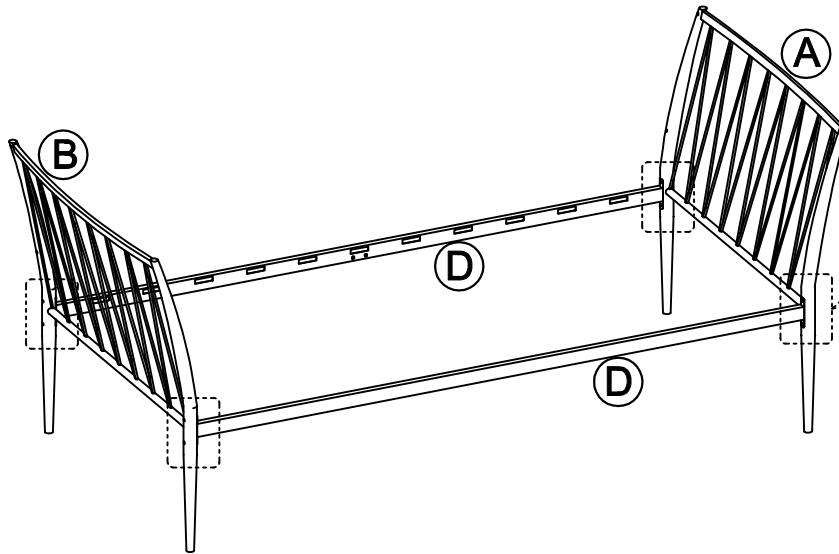

## Step 1

①		8
⑦		1

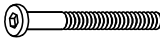

Assemble Platforms (D) to Headboard (A) &(B) using Bolts (1) as shown above, do not tighten bolts until Step 5.

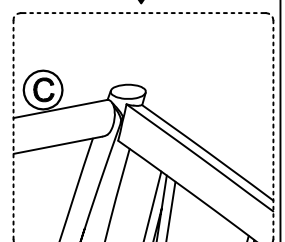
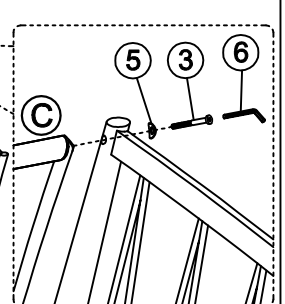
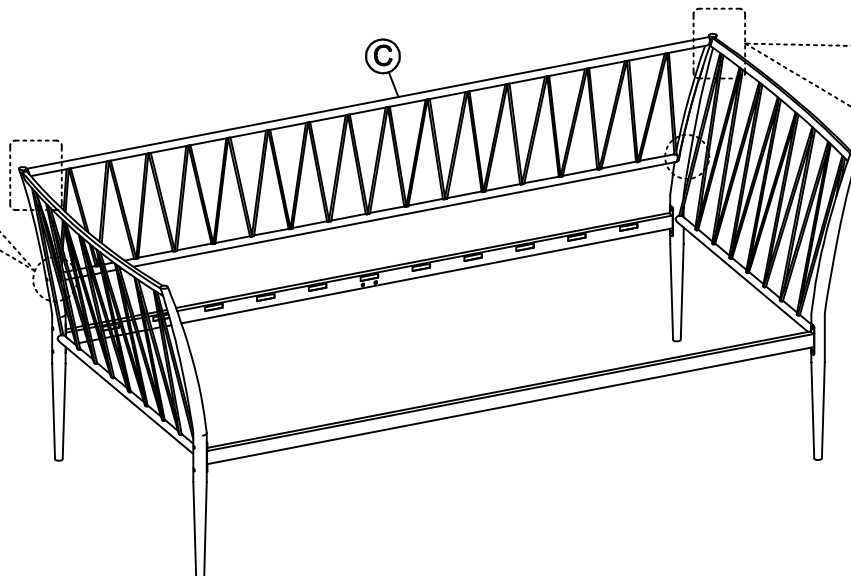
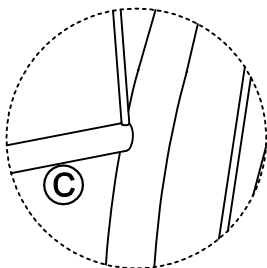
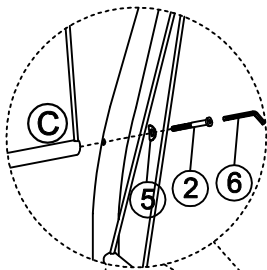

## Step 2

②		2
③		2
⑤		4
⑥		1



Assemble Backrest (C)to Headboard (A) &(B) using Bolts (2&3) and Washers (5) as shown above, do not tighten bolts until Step 5.

### Step 3

④		4
⑥		1

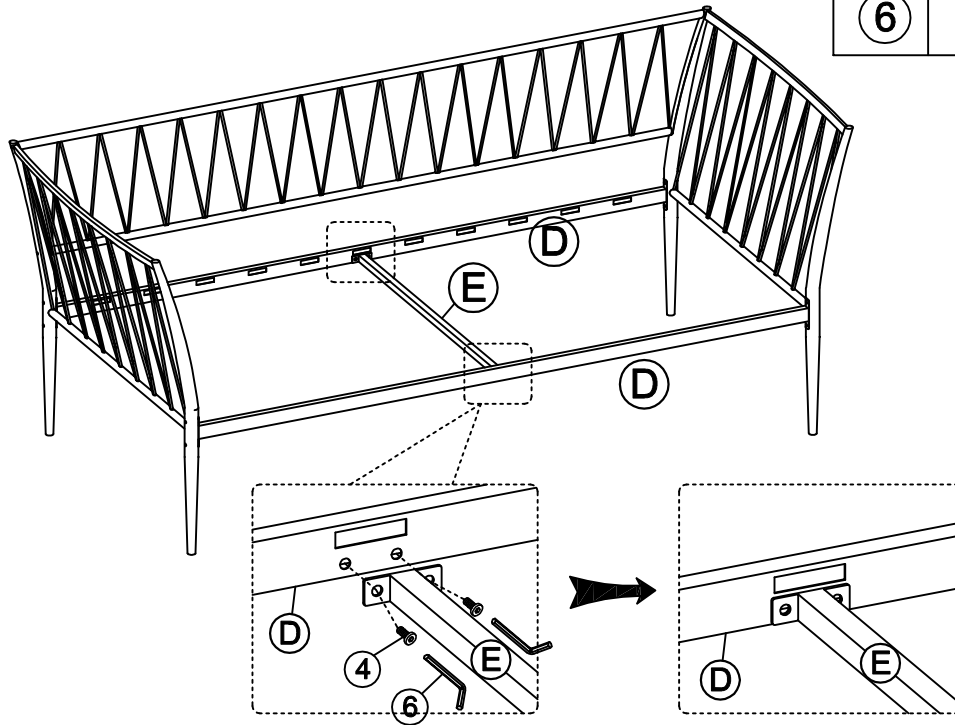

Assemble Support Bar (E) to Side Rails(D) using Bolts (4) as shown above, do not tighten bolts until Step 5.

### Step 4

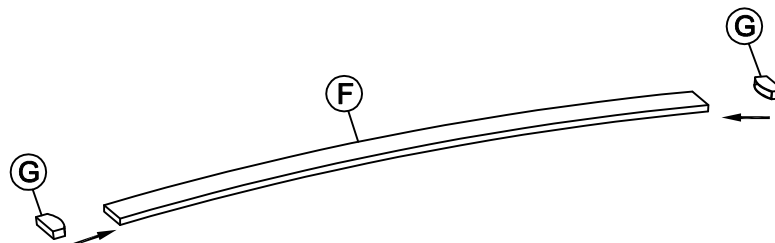

Insert Plastic Caps (G) to Slats (F) as shown above.

x 11

## Step 5

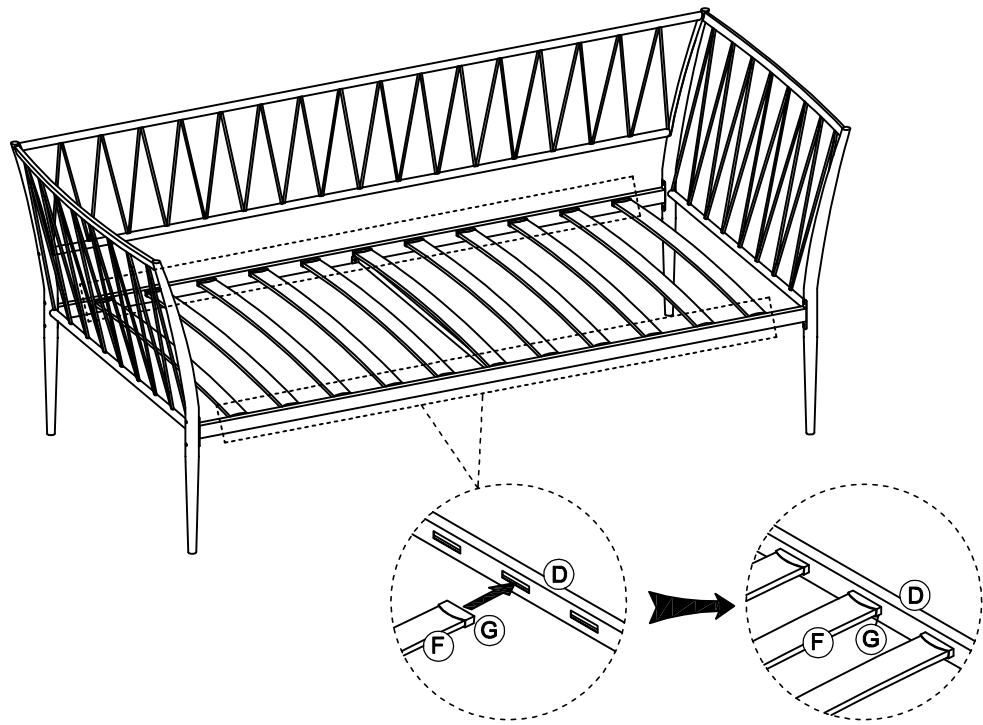

Insert Plastic Caps (G) into holes on Side Rails (D) as shown above. Please tighten all bolts at this point.

## Step 6

