

ASSEMBLY INSTRUCTIONS

Style # C1106-WH &C1106-AV
&C1106-CA&C1106-LP
&C1106-BU Console Table

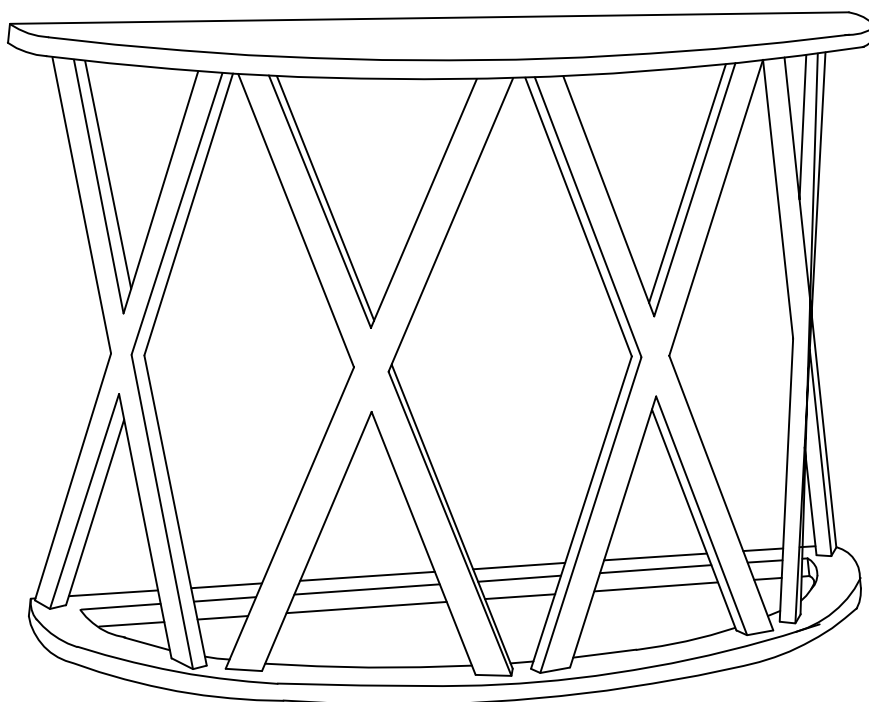

NOTE TO CUSTOMERS:

- For ease and speed of assembly we recommend that before you commence each step of the assembly that you identify all the parts required to complete that step.
- We recommend that where possible you allow sufficient space to assemble the item as close as possible to the place where it will be once assembled.
- For the protection of your furniture we recommend that the product is placed on protected surfaces during assembly to prevent any damage.
- During assembly do not over tighten ,as this may damage the product.
- Please ensure you retain all the product packaging until the item completely assembled.
- Please periodically check all fittings and re-tighten as necessary.
- Never allow any liquids to remain on your furniture as absorption can cause the wood to warp or the finish to de-laminate.
- It is recommended that this item should be assembled by two adults.

Part List

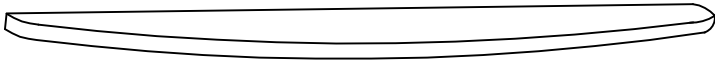
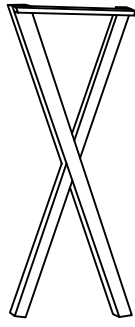
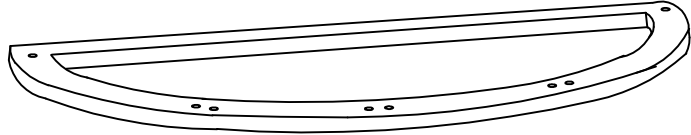

| | |
|--|--|
| <p>A1</p> <p style="text-align: right;">Quantity of 1</p>  <p>Top Panel</p> | <p>A2</p> <p style="text-align: right;">Quantity of 4</p>  <p>Support Frame</p> |
| <p>A3</p> <p style="text-align: right;">Quantity of 1</p>  <p>Bottom Panel</p> | |

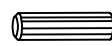
Hardware List

| | |
|---|---|
| <p>B1</p> <p style="text-align: right;">Quantity of 16</p>  <p>Screw</p> | <p>B2</p> <p style="text-align: right;">Quantity of 8</p>  <p>Wood Dowel</p> |
|---|---|

Assembly instructions

Step 1:

| | | |
|-----|---|------|
| B1: |  | 8PCS |
| B2: |  | 8PCS |

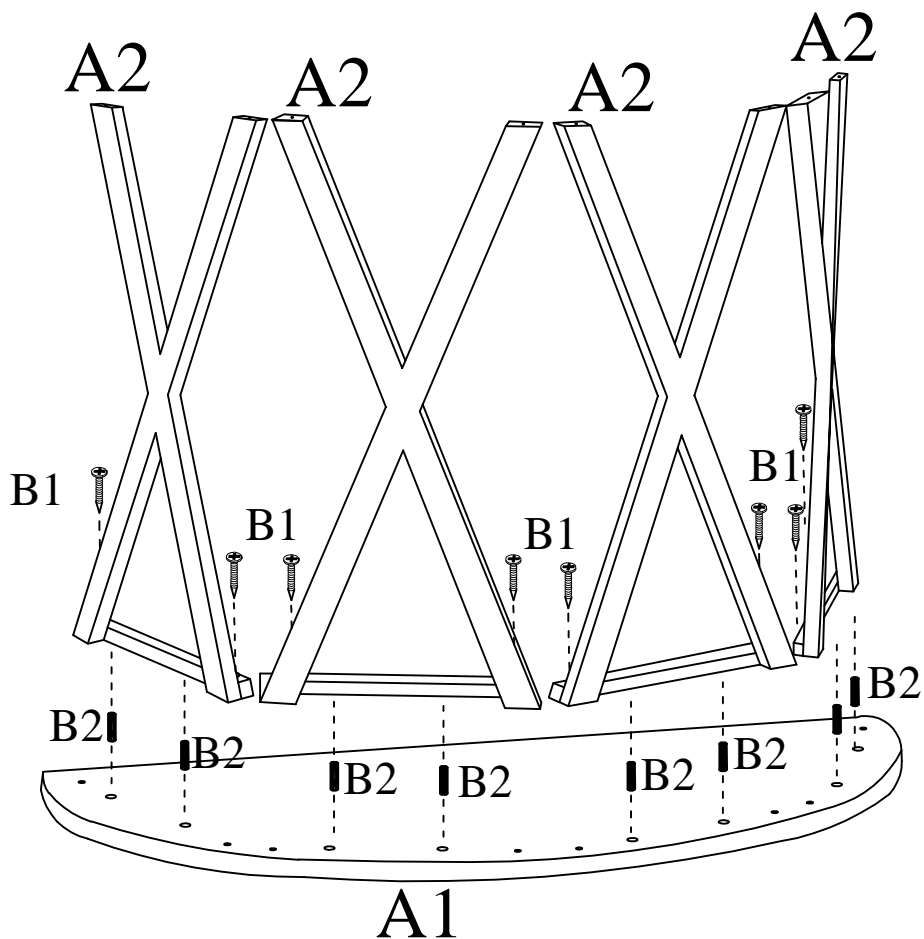

Assemble Support Frames A2 to the bottom of Top Panel A1 using Screws B1 & Wood Dowel B2 as shown above.

Step 2:

B1:  8PCS

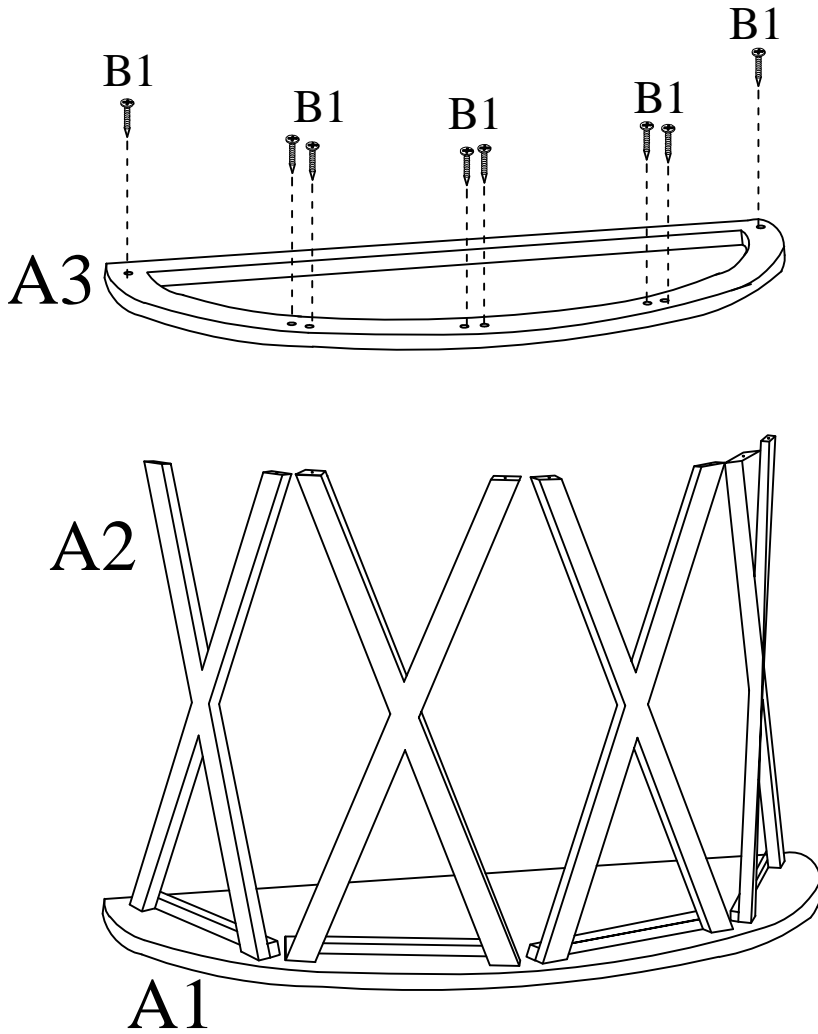

Assemble Bottom Frame A3 to Support Frames A2 using Screws B1 as shown above.