

# ASSEMBLY INSTRUCTION

## Upholstered Bed Frame

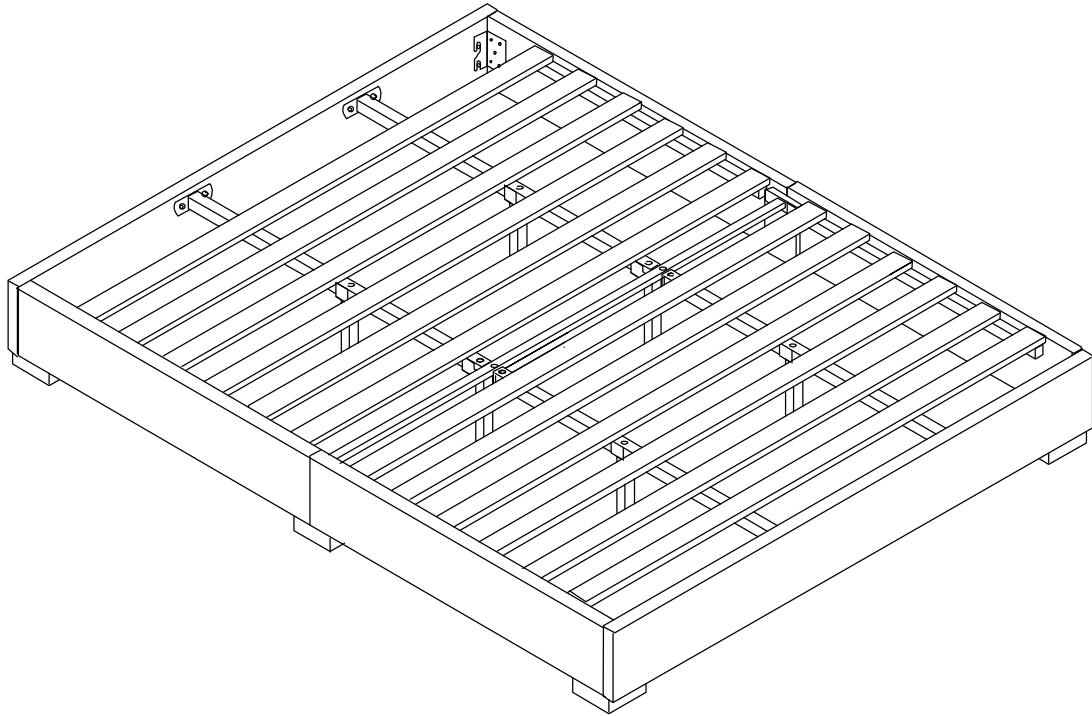

### KING SIZE





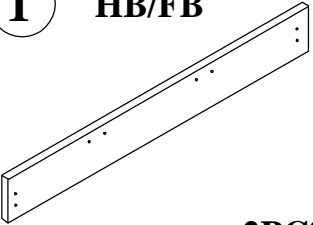
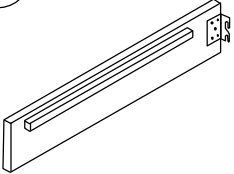
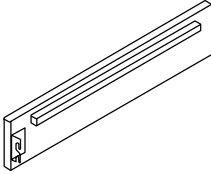
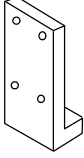
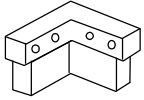
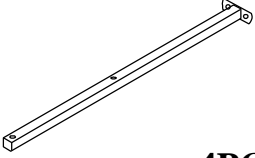

### NOTE TO CUSTOMERS:

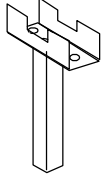
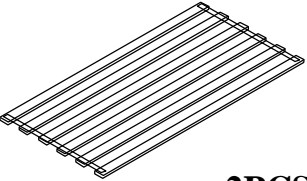
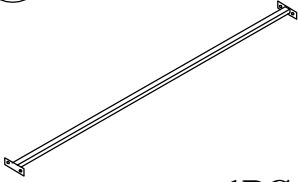
1. For ease and speed of assembly we recommend that before you commence each step of the assembly that you identify all the parts required to complete that step.
2. We recommend that where possible you allow sufficient space to assemble the item as close as possible to the place where it will be once assembled.
3. For the protection of your furniture we recommend that the product is placed on protected surfaces during assembly to prevent any damage.
4. During assembly do not over-tighten, as this may damage the product.
5. Please ensure you retain all the product packaging until the item is completely assembled.
6. Please periodically check all fittings and re-tighten as necessary.
7. Never allow any liquids to remain on your furniture as absorption can cause the surface to warp or the finish to de-laminate.
8. It is recommended that this item should be assembled by two adults.

## PART LIST

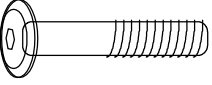
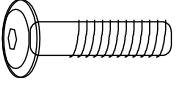
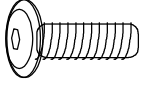
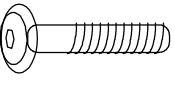
<b>1</b> HB/FB  <b>2PCS</b>	<b>2</b> Side Rail  <b>2PCS</b>	<b>3</b> Side Rail  <b>2PCS</b>	<b>4</b> Side Leg  <b>2PCS</b>
<b>5</b> Metal Leg  <b>4PCS</b>	<b>6</b> Center Rail  <b>4PCS</b>	<b>7</b> Support Leg  <b>4PCS</b>	<b>8</b> Support Leg  <b>2PCS</b>
<b>9</b> Slats  <b>2PCS</b>	<b>10</b> Center Bar  <b>1PC</b>		

## HARDWARE LIST

<b>A</b> M8*60mm  <b>Bolt 16PCS</b>	<b>B</b> M8*45mm  <b>Bolt 10PCS</b>	<b>C</b> M8*20mm  <b>Bolt 16PCS</b>	<b>D</b> M6*38mm  <b>Bolt 8PCS</b>
<b>E</b>  <b>Washer 42PCS</b>	<b>F</b>  <b>M5 Allen Key 1PC</b>	<b>G</b>  <b>M4 Allen Key 1PC</b>	



### WARNING:

1. Always use the recommended size of mattress or mattress support to help prevent the likelihood of entrapment or falls.
2. For your safety do not jump on the bed.
3. The use of water or sleep flotation mattress on the bed is not recommended.
4. The weight load on this bed should never exceed 500lbs. Exceeding this weight limit may cause the bed to collapse, resulting in serious personal injury and property damage.

# STEP 1

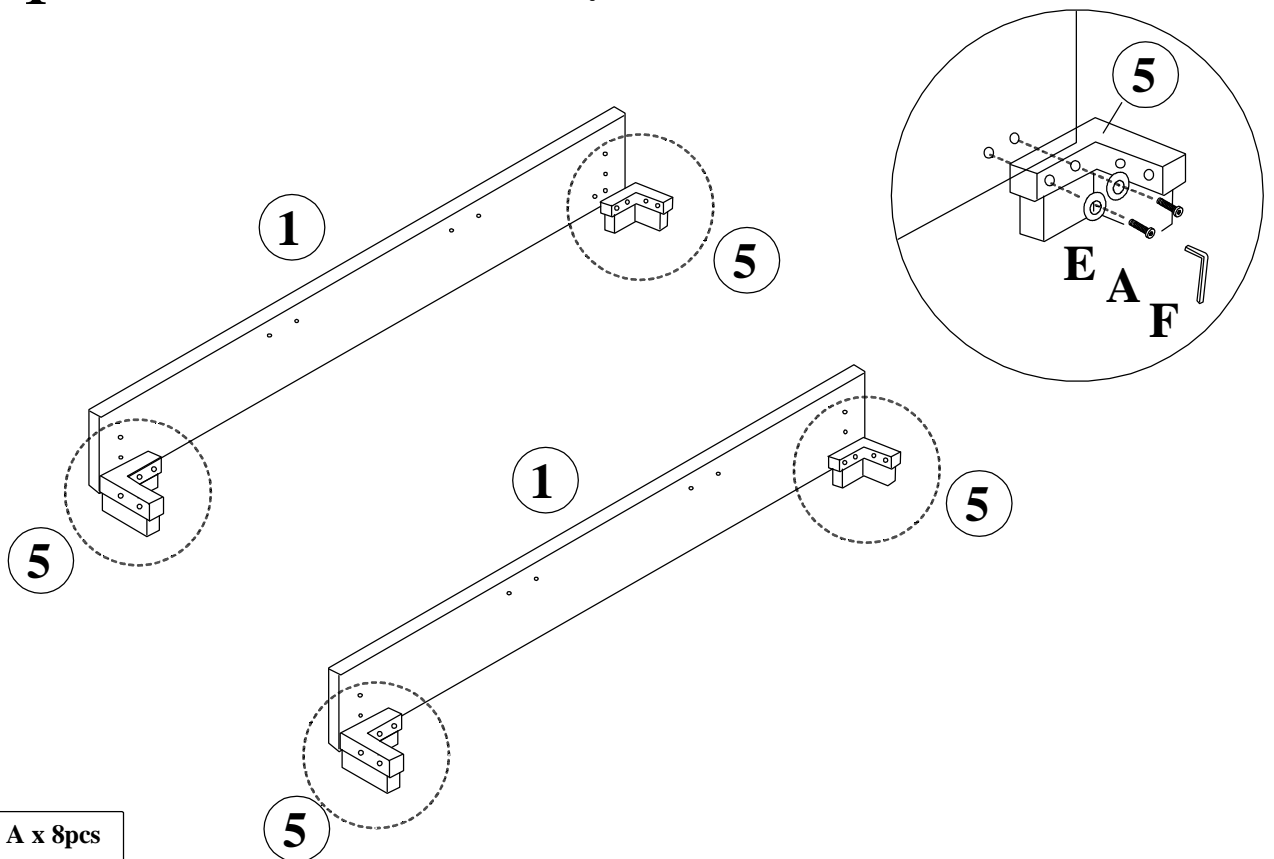
## Assembly instructions





	A x 8pcs
	E x 8pcs
	F x 1pc

Assemble Metal Legs (5) to HB/FB(1) using Bolts (A) and Washers (E) as shown above.

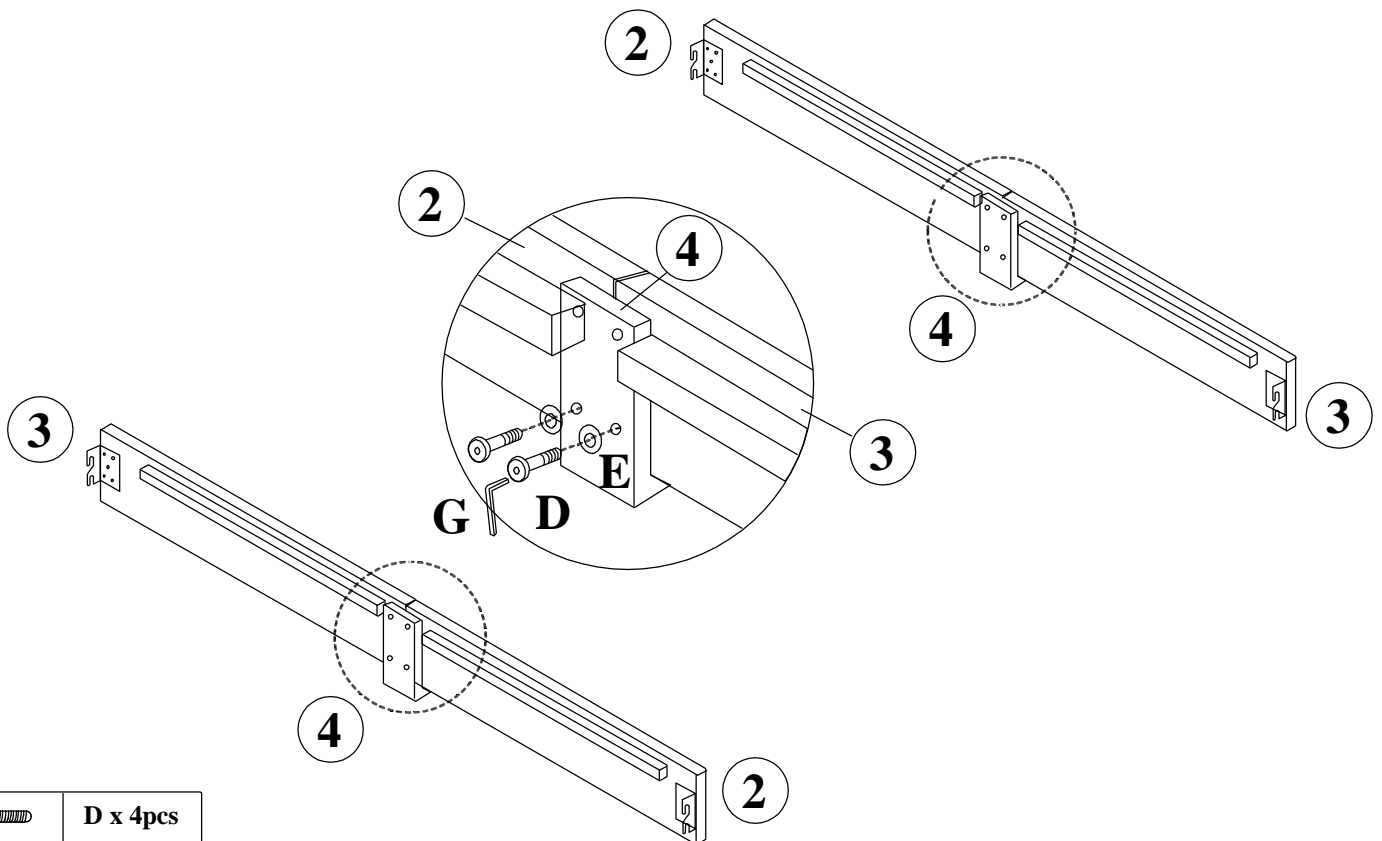
# STEP 2





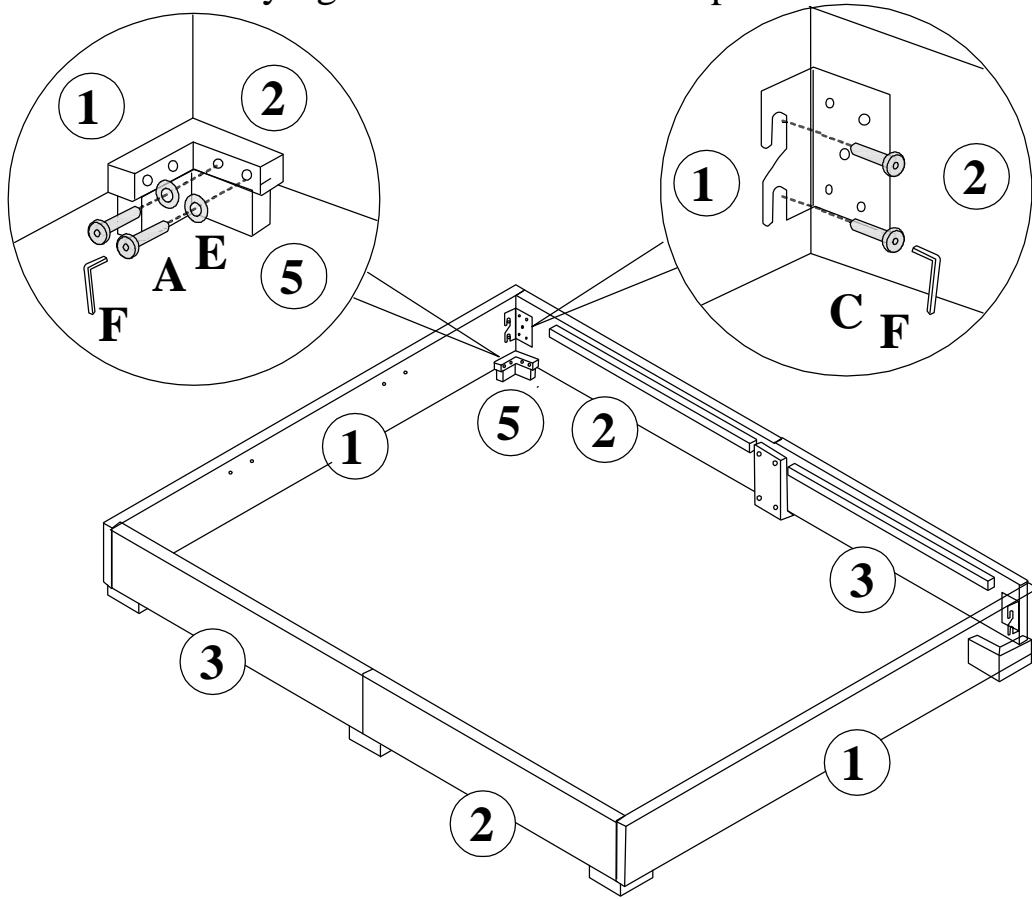

	D x 4pcs
	E x 4pcs
	G x 1pc

Assemble Side Legs(4) to Side Rails(2&3) using Bolts (D) & Washers(E) as shown above.

**STEP 3** NOTE: Do not fully tighten all Bolts until Step 6.





	A x 8pcs
	C x 8pcs
	E x 8pcs
	F x 1pc

Assemble Side Rails(3) to HB/FB(1) using Bolts (C) as shown above, Then assemble Side Rails(2&3) to Metal Legs(5) using Bolts (A) & Washers (E) as shown above.

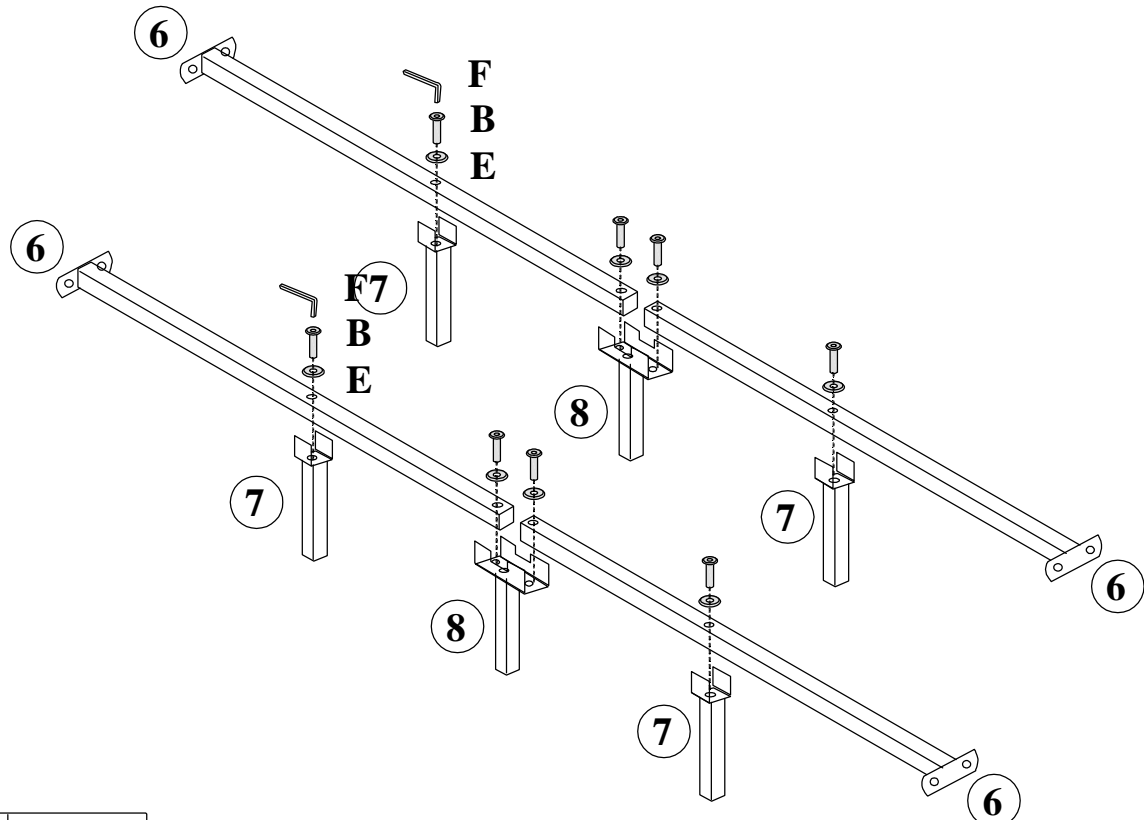
**STEP 4** NOTE: Do not fully tighten all Bolts until Step 6.







	B x 8pcs
	E x 8pcs
	F x 1pc

Assemble Support Legs (7&8) to Center Rails (6) using Bolts (B) & Washers (E) as shown above.

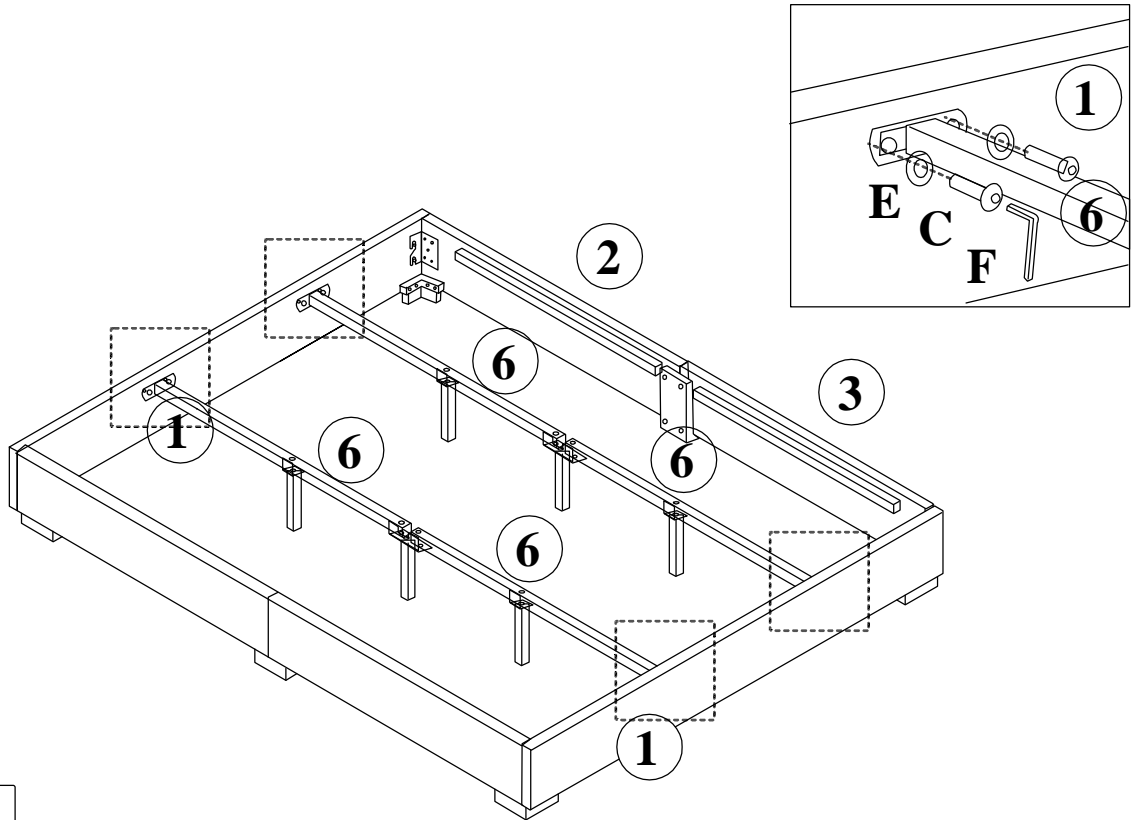
# STEP 5

NOTE: Do not fully tighten all Bolts until Step 6.







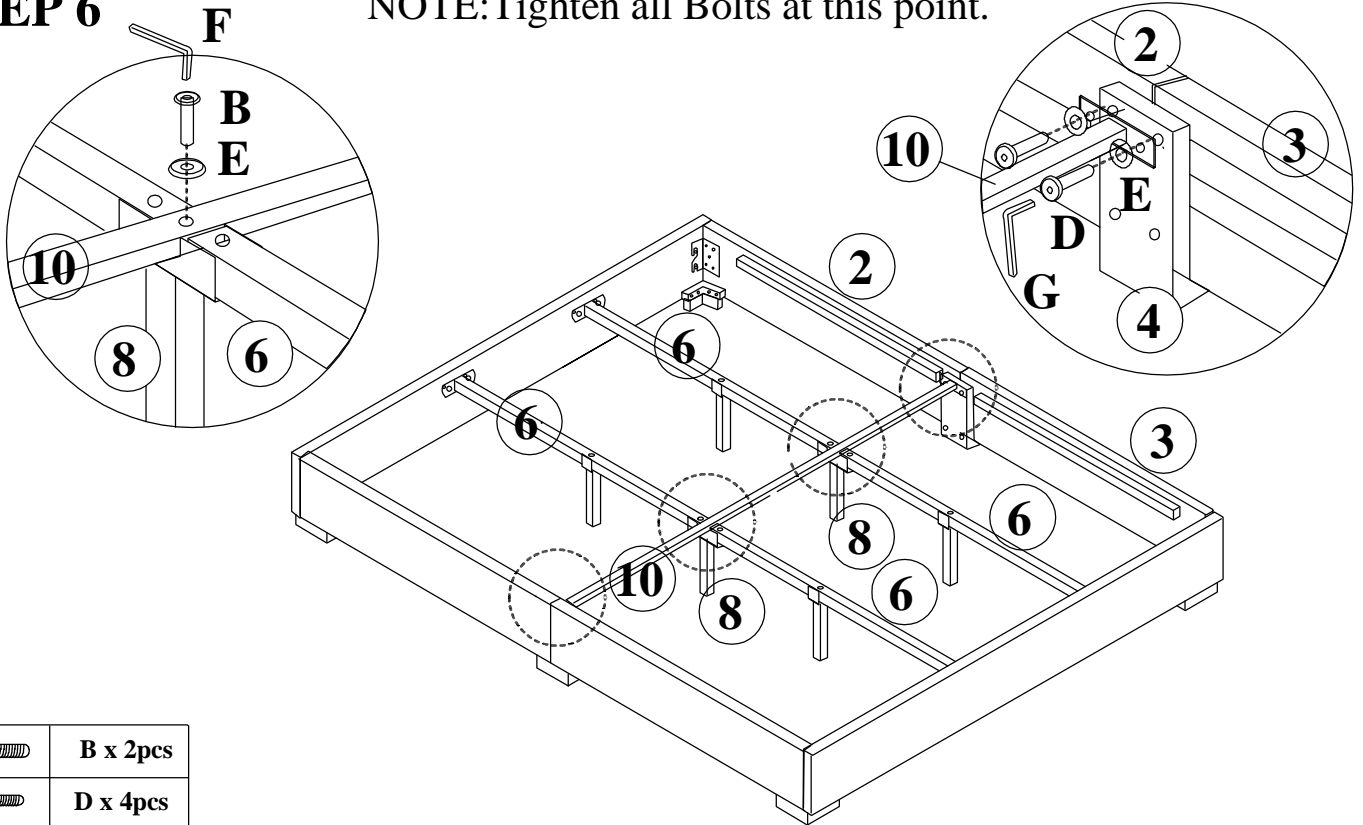

	C x 8pcs
	E x 8pcs
	F x 1pc

Assemble Center Rails(6) to HB/FB(1) using Bolts(C) & Washers (E) as shown above.

# STEP 6

NOTE: Tighten all Bolts at this point.



	B x 2pcs
	D x 4pcs
	E x 6pcs
	F x 1pc
	G x 1pc

Assemble Center Bar (10) to Side Legs(4) & Support Legs(8) using Bolts (B&D) & Washers (E) as shown above.

## STEP 7

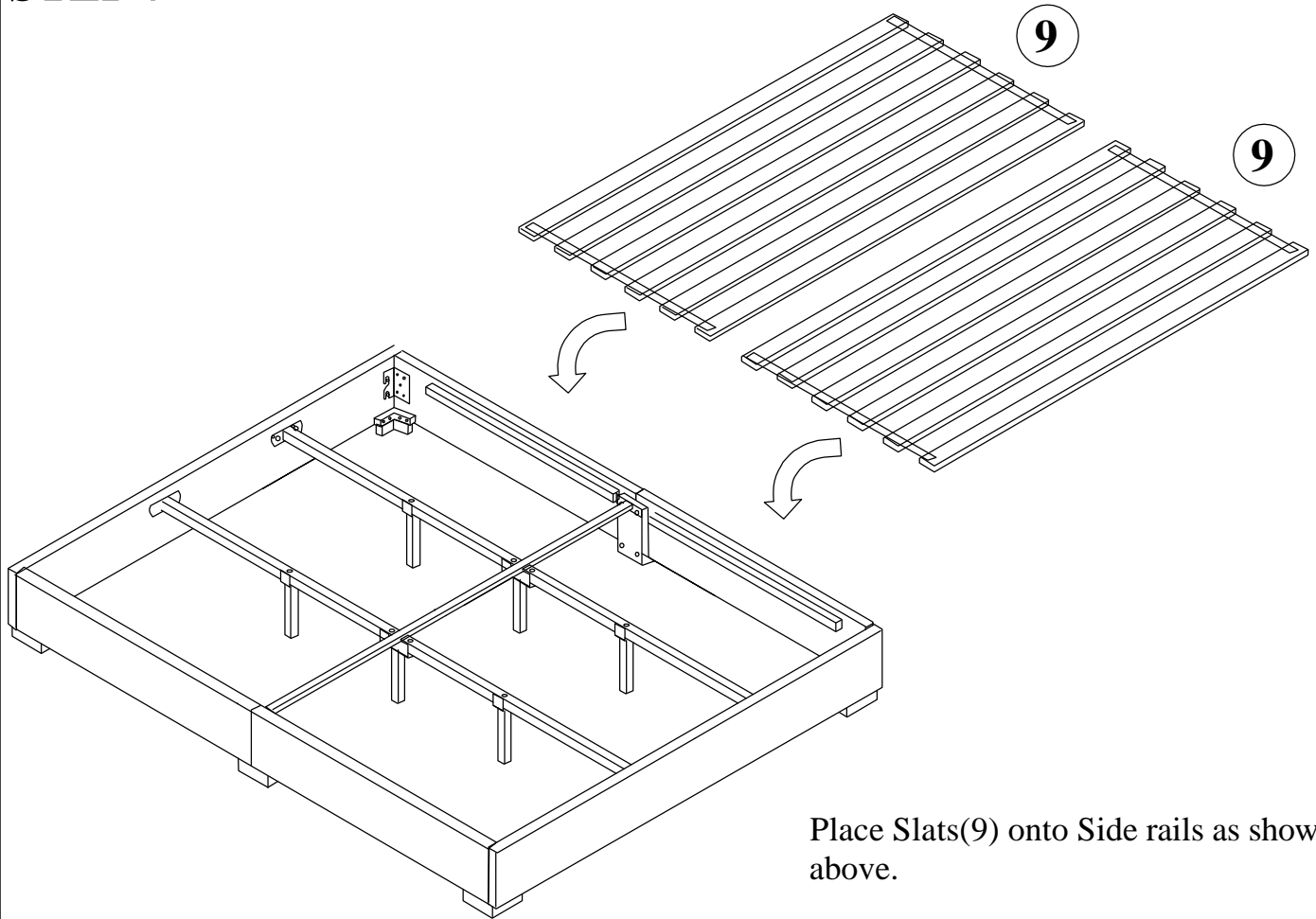

Place Slats(9) onto Side rails as shown above.

## STEP 8

