







ASSEMBLY INSTRUCTIONS

**MODEL : 0304A/0304B
NIGHT STAND**

**(BOX 1)
BOX OF NIGHT STAND**

| NO | ITEM | QTY |
|----|--|-------|
| A | NIGHT STAND  | 1 pc |
| B | BUN FOOT  | 4 pcs |

**(BOX 1)
HARDWARE LIST**

| NO | ITEM | QTY |
|----|--|-------|
| 1 | JCBC Bolt m6x50mm Blk  | 4 pcs |
| 2 | Spring Washer 1/4" Blk  | 4 pcs |
| 3 | Flat Washer 1/4"IDx13mmOD Blk  | 4 pcs |
| 4 | Allen Key m-4x110mm With Ball Blk  | 1 pc |

STEP 1 : Pull the bottom drawer and take out the Bunfoot carton (B). Assemble the Bun Foot (B) with JCBC Bolt (1),Spring washer (2),Flatwasher (3) and securing with Allen Key (4) as shown.

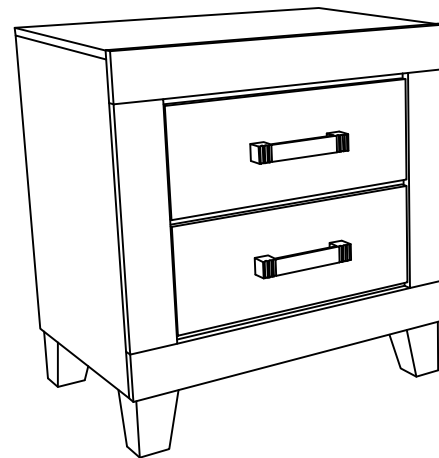
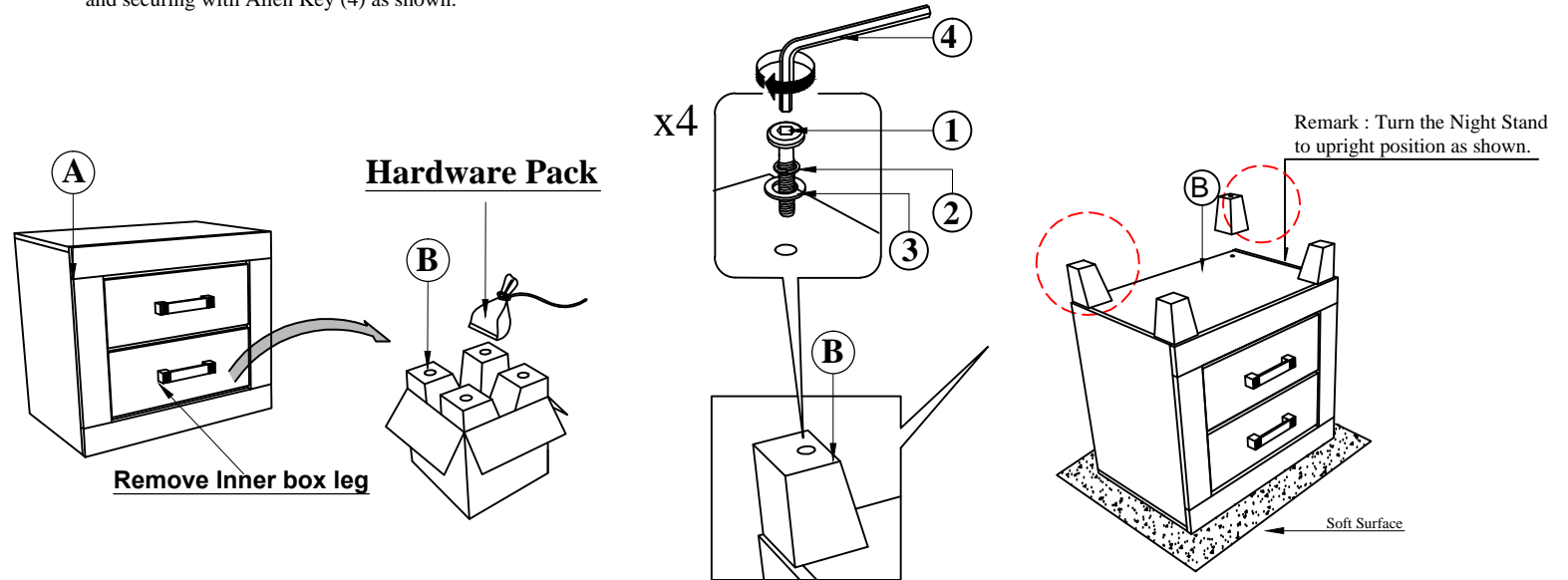

COMPLETED ASSEMBLY

NOTE : MUST TIGHTEN SCREWS **PERIODICALLY** WITH USE SCREW WILL BECOME LOOSE CHECK TIGHTNESS OF ALL SCREW EVERY 6-8 WEEKS.