



ASSEMBLY INSTRUCTIONS

**MODEL : 0401A
NIGHT STAND**

STEP 1 : Pull the bottom drawer and take out the Bunfoot carton (B). Assemble the Bun Foot (B) with JCBC Bolt (1),Spring washer (2),Flatwasher (3) and securing with Allen Key (4) as shown.

(BOX 1)



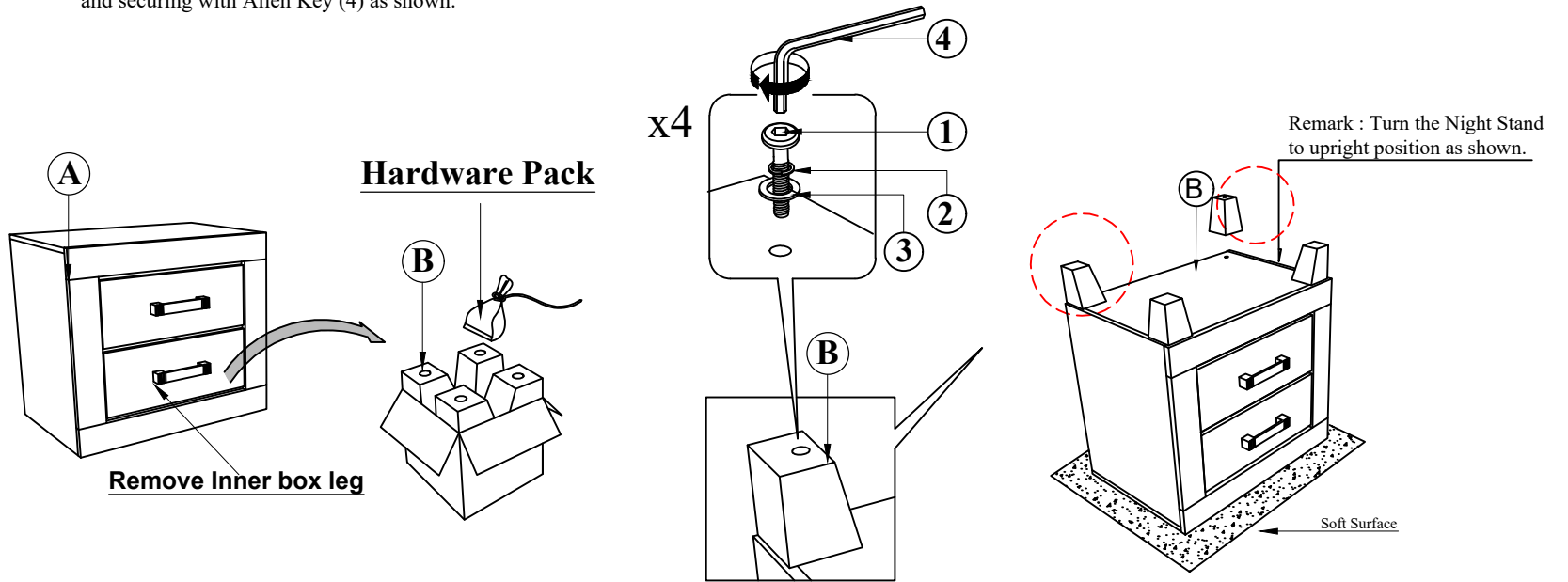

BOX OF NIGHT STAND

NO	ITEM	QTY
A	NIGHT STAND 	1 pc
B	BUN FOOT 	4 pcs



(BOX 1)

HARDWARE LIST

NO	ITEM	QTY
1	JCBC Bolt m6x50mm Blk 	4 pcs
2	Spring Washer 1/4" Blk 	4 pcs
3	Flat Washer 1/4"IDx13mmOD Blk 	4 pcs
4	Allen Key m4x110mm With Ball Blk 	1 pc

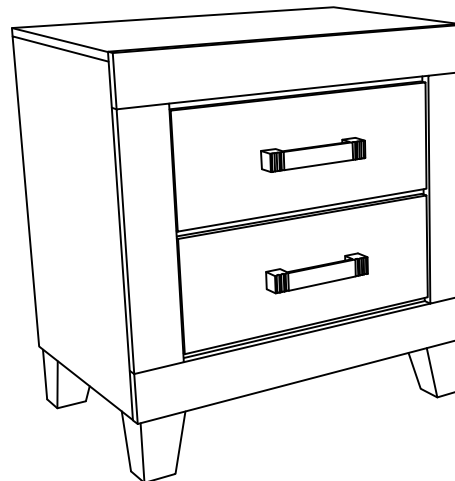

COMPLETED ASSEMBLY

NOTE : MUST TIGHTEN SCREWS **PERIODICALLY** WITH USE SCREW WILL BECOME LOOSE CHECK TIGHTNESS OF ALL SCREW EVERY 6-8 WEEKS.