



# ASSEMBLY INSTRUCTIONS

**MODEL : 0401A  
DRESSER**

**STEP 1 :** Pull the bottom drawer and take out the Bunfoot carton ( B ). Assemble the Bun Foot (B) with JCBC Bolt (1),Spring washer (2),Flatwasher (3) and securing with Allen Key (4) as shown.

**(BOX 1)**



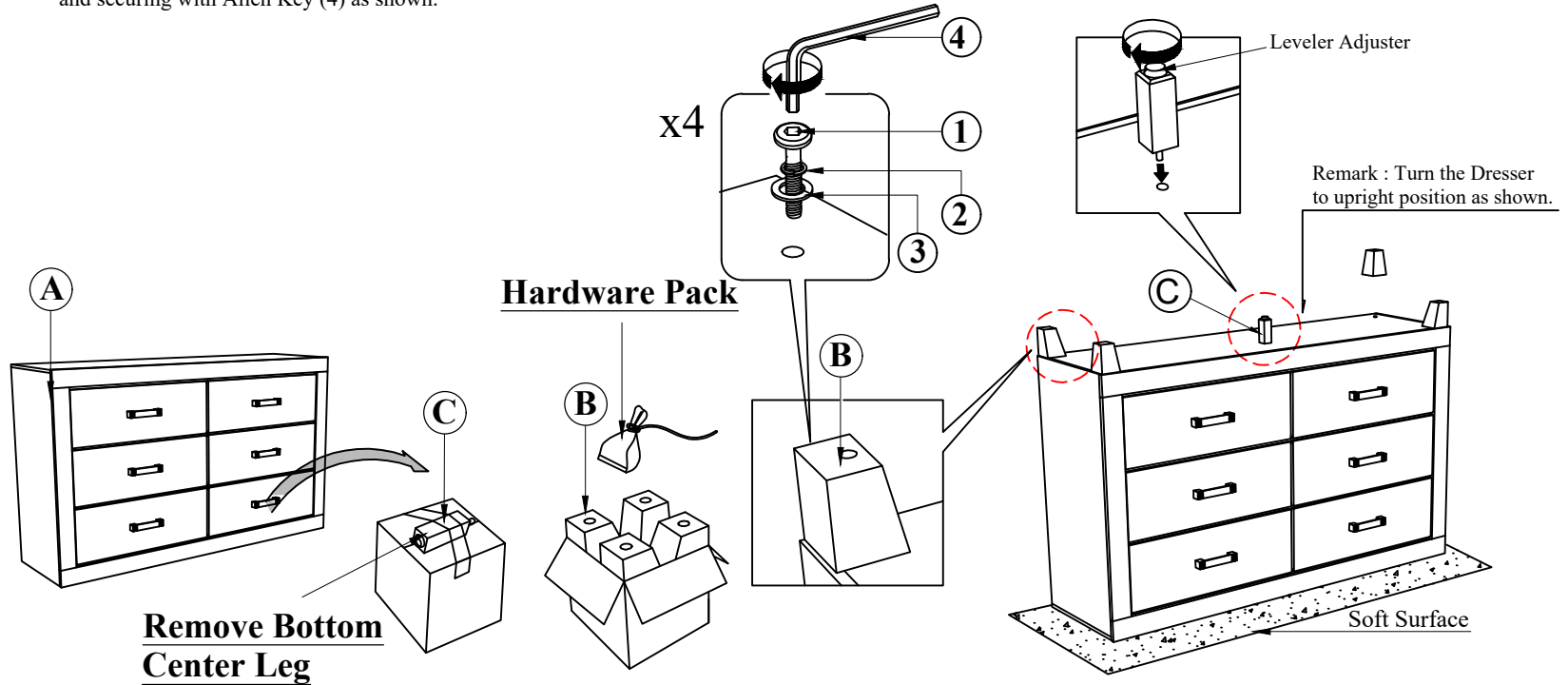

**BOX OF DRESSER**

NO	ITEM	QTY
A	DRESSER 	1 pc
B	BUN FOOT 	4 pcs
C	BOTTOM CENTER LEG 	1 pc



**(BOX 1)**

**HARDWARE LIST**

NO	ITEM	QTY
1	JCBC Bolt m6x50mm Blk 	4 pcs
2	Spring Washer 1/4" Blk 	4 pcs
3	Flat Washer 1/4"IDx13mmOD Blk 	4 pcs
4	Allen Key m4x110mm With Ball Blk 	1 pc



**COMPLETED ASSEMBLY**

**NOTE :** MUST TIGHTEN SCREWS **PERIODICALLY** WITH USE SCREW WILL BECOME LOOSE CHECK TIGHTNESS OF ALL SCREW EVERY 6-8 WEEKS.