

ASSEMBLY INSTRUCTIONS

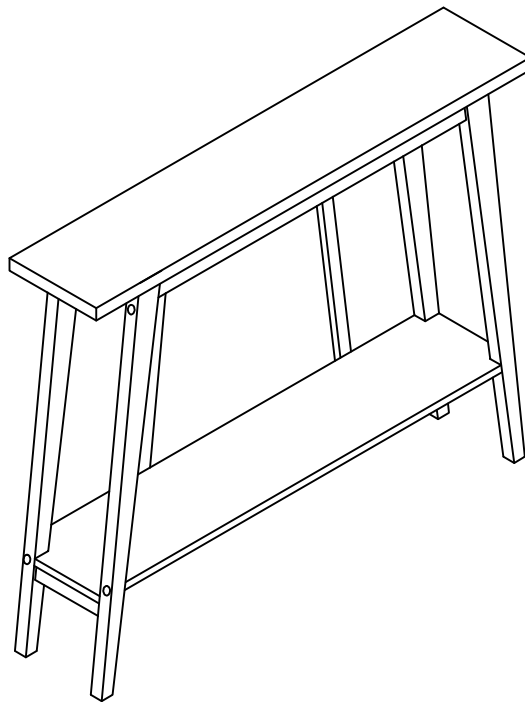

Style#C1107 Console Table



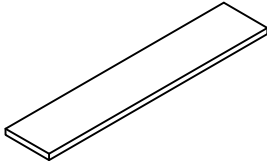
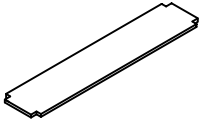
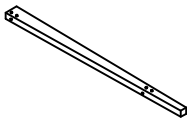
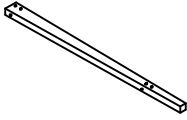

NOTE TO CUSTOMERS:

- For ease and speed of assembly we recommend that before you commence each step of the assembly that you identify all the parts required to complete that step.
- We recommend that where possible you allow sufficient space to assemble the item as close as possible to the place where it will be once assembled.
- For the protection of your furniture we recommend that the product is placed on protected surfaces during assembly to prevent any damage.
- During assembly do not over tighten, as this may damage the product.
- Please ensure you retain all the product packaging until the item completely assembled.
- Please periodically check all fittings and re-tighten as necessary.
- It is recommended that this item should be assembled by two adults.





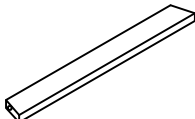
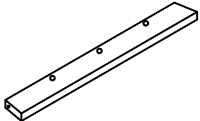

Furniture Parts

ITEM	DESCRIPTION	PART	QTY
A1	Top Panel		1
A2	Shelf		1
A3	Leg		2
A4	Leg		2
A5	Connect Bar		4



Furniture Parts

ITEM	DESCRIPTION	PART	QTY
A6	Front Apron		1
A7	Rear Apron		1
A8	Left Support Bar		1
A9	Right Support Bar		1

Hardware Parts

ITEM	DESCRIPTION	PART	QTY
B1	Cam-lock		14
B2	Wood Dowel	 Dia 0.315**1.2*L	8
B3	Bolt with nut	 Dia 0.25**3*L	8
B4	Screw	 Dia 0.15**0.6*L	4
B5	Wall Anchor	 Dia 0.15**1.5*L	1
B6	Allen Wrench		1

Hardware Parts

ITEM	DESCRIPTION	PART	QTY
B7	Screw	 Dia 0.12**0.5*L	1
B8	Flat Washer		2
B9	Safety wall strap		1

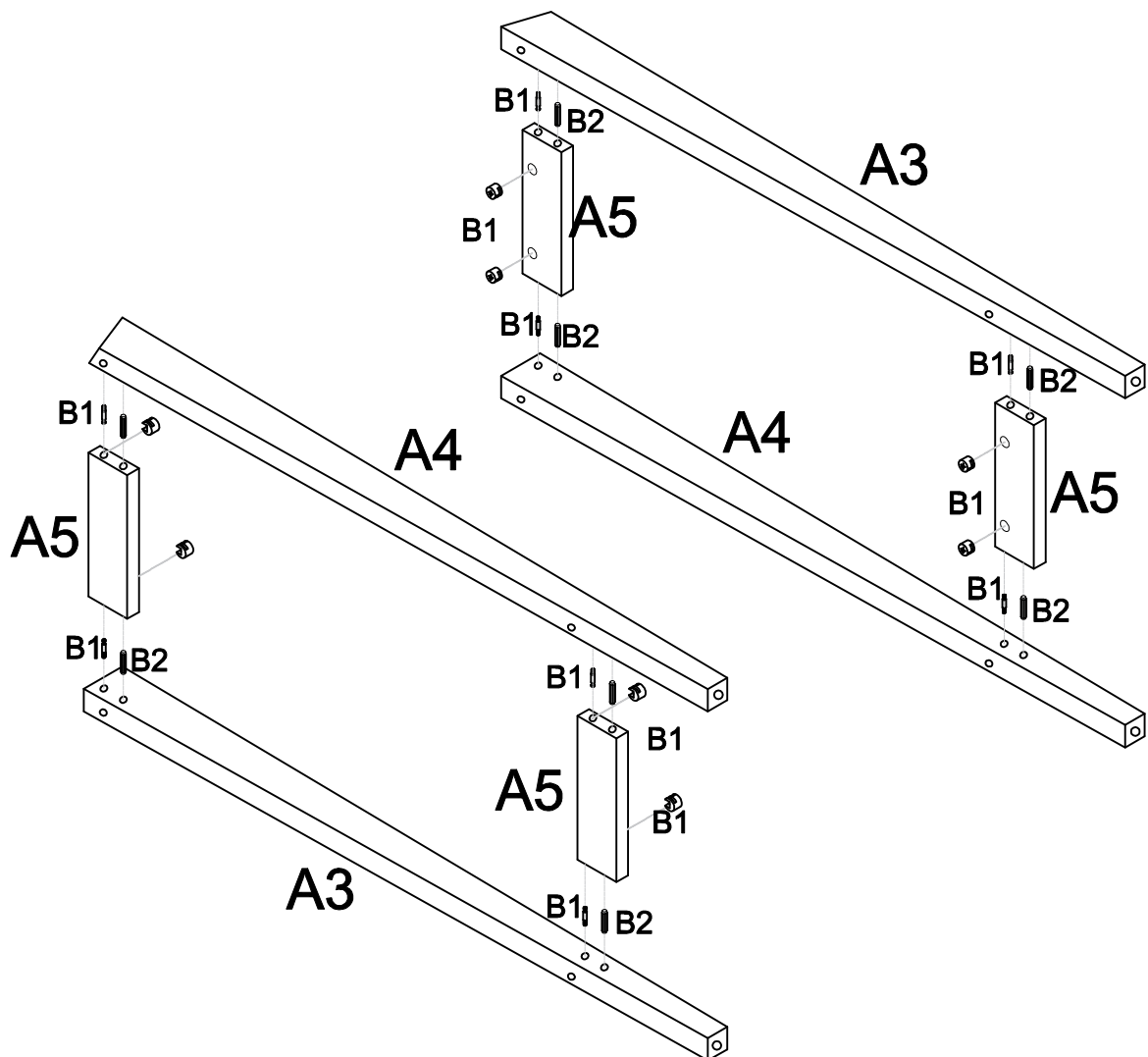
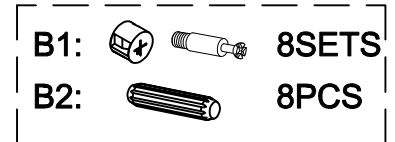

ASSEMBLY INSTRUCTIONS

STEP 1



Assemble Connect Bars A5 to Legs A3 & A4 using Cam-locks B1 & Wood Dowels B2 as shown above.

STEP 2

B3:		8SETS
B6:		1PCS

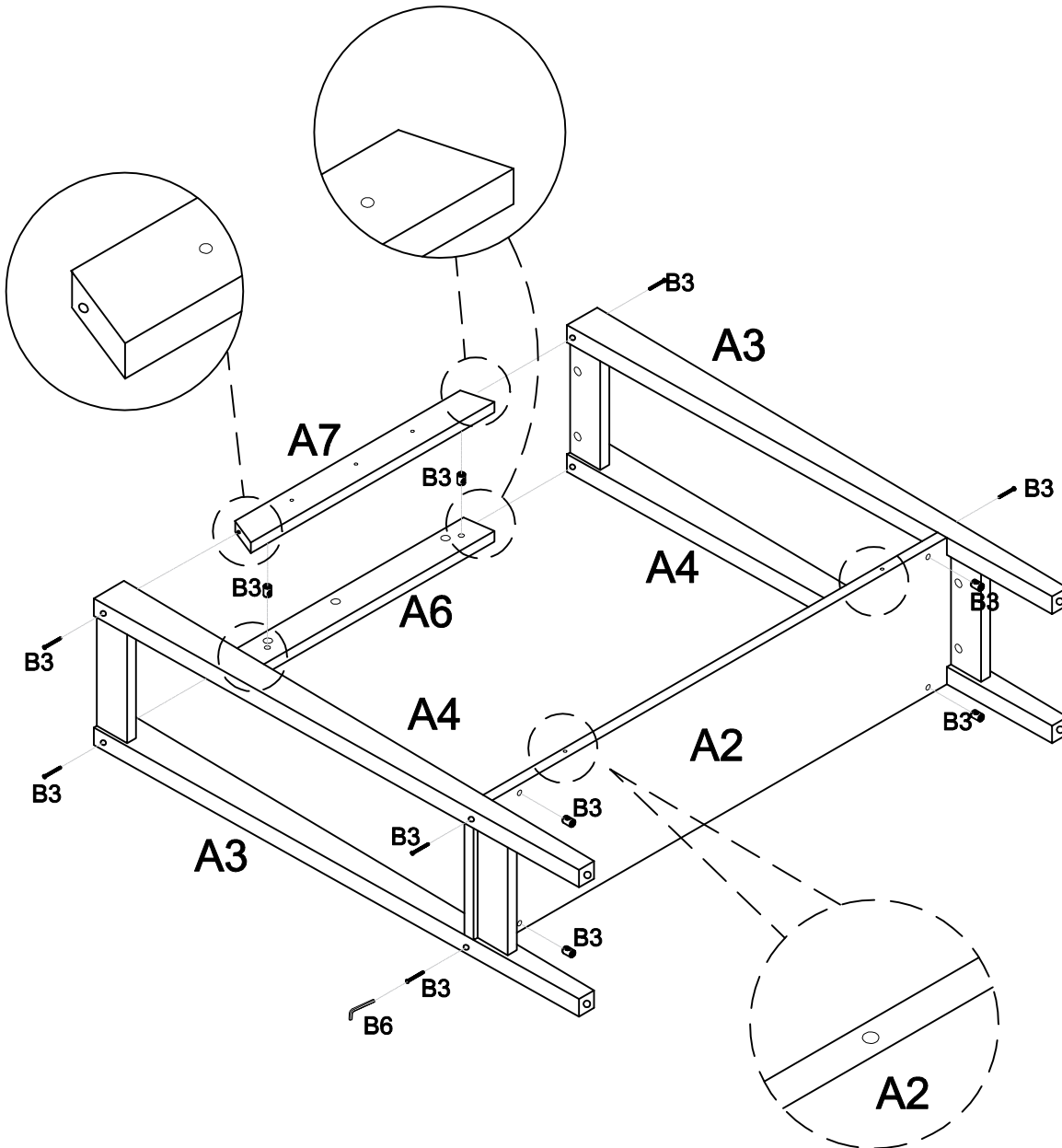

Assemble Aprons A6 & A7 and Shelf A2 to Legs A3 & A4 using Bolts with nuts B3 as shown above.

STEP 3

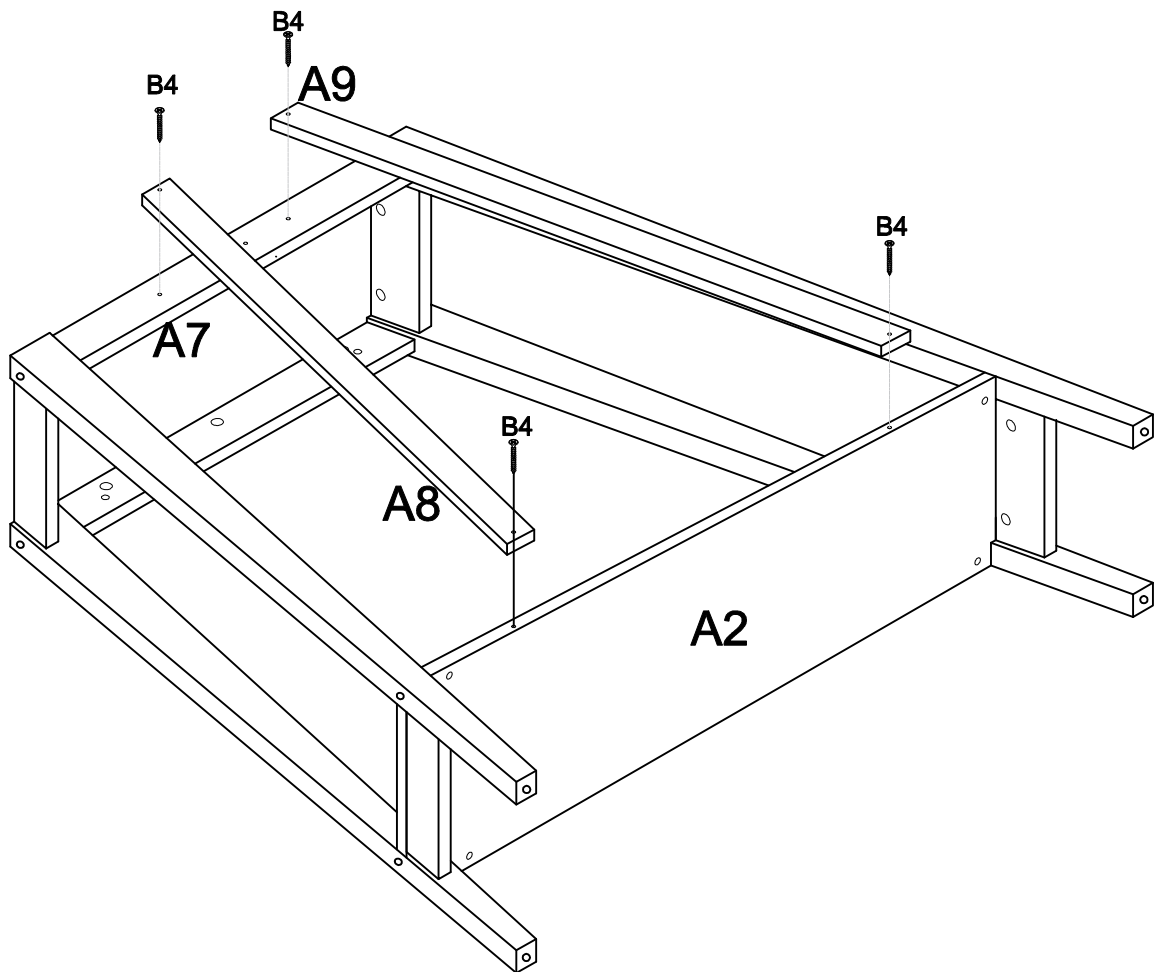

B4:  4PCS

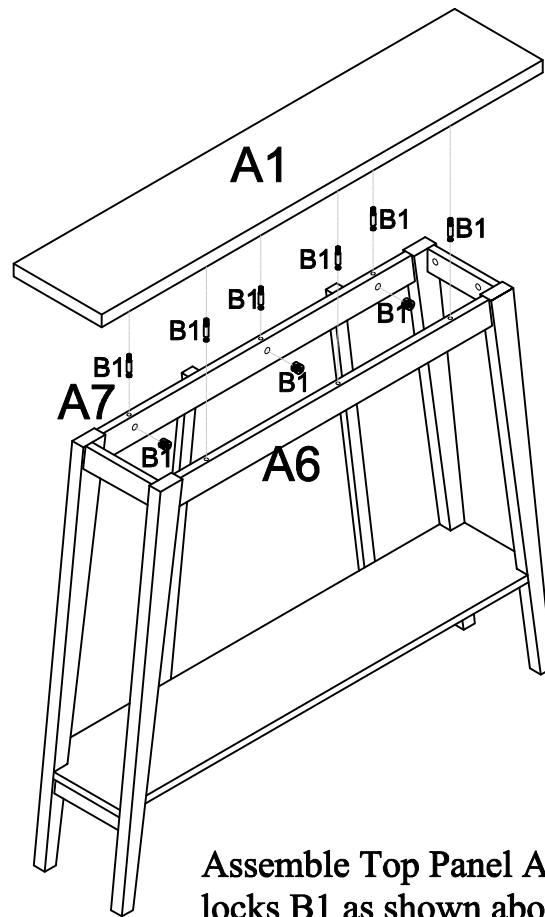

Assemble Support Bars A8 & A9 to Rear Apron A7 using Screws B4 as shown above.

STEP 4





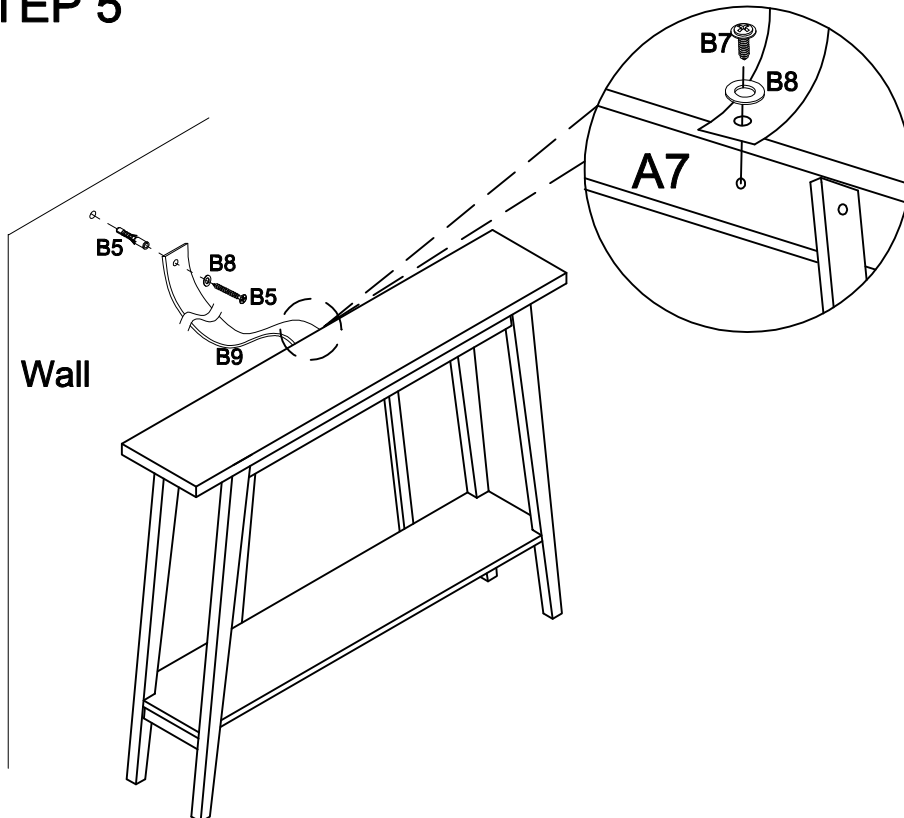

B1:   6SETS

Assemble Top Panel A1 to Aprons A6 & A7 using Camlocks B1 as shown above.

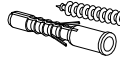
STEP 5



B5:  1SET
B7:  1PC
B8:  2PC
B9:  1PC

For your safety, please attach unit to the wall with Wall Anchor B5 , Flat Washer B8 , Screw B7 and Safety Wall Trap B9 as shown above.