

ASSEMBLY INSTRUCTIONS

Style # WR1434 Wine Rack

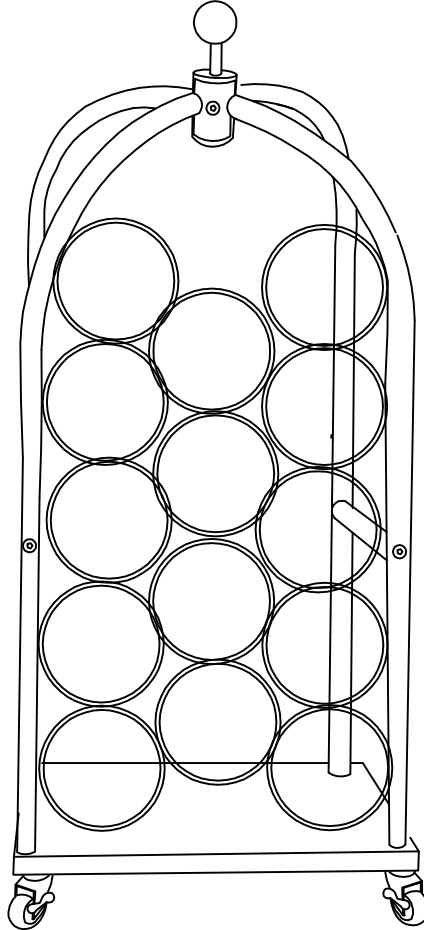





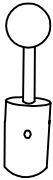
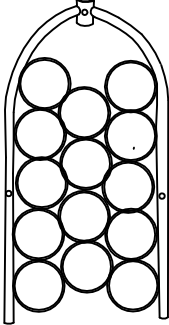
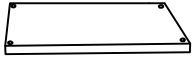
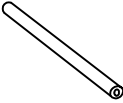

NOTE TO CUSTOMERS:

- For ease and speed of assembly we recommend that before you commence each step of the assembly that you identify all the parts required to complete that step.
- We recommend that where possible you allow sufficient space to assemble the item as close as possible to the place where it will be once assembled.
- For the protection of your furniture we recommend that the product is placed on protected surfaces during assembly to prevent any damage.
- During assembly do not over tighten ,as this may damage the product.
- Please ensure you retain all the product packaging until the item completely assembled.
- Please periodically check all fittings and re-tighten as necessary.
- Never allow any liquids to remain on your furniture as absorption can cause the wood to warp or the finish to de-laminate.
- It is recommended that this item should be assembled by two adults.

Part List

<p>A1 Quantity of 1</p> <div style="text-align: center; margin: 20px 0;">  </div> <p>Connect Block</p>	<p>A2 Quantity of 2</p> <div style="text-align: center; margin: 20px 0;">  </div> <p>Side Frame</p>	<p>A3 Quantity of 1</p> <div style="text-align: center; margin: 20px 0;">  </div> <p>Bottom Panel</p>
<p>A4 Quantity of 2</p> <div style="text-align: center; margin: 20px 0;">  </div> <p>Connect Bar</p>		

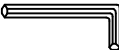
Hardware List

<p>B1 Quantity of 4</p> <div style="text-align: center; margin: 20px 0;">  <p>1/8"*1"</p> </div> <p>Bolt</p>	<p>B2 Quantity of 1</p> <div style="text-align: center; margin: 20px 0;">  </div> <p>Bolt with Nut</p>	<p>B3 Quantity of 2</p> <div style="text-align: center; margin: 20px 0;">  </div> <p>Wheel</p>
<p>B4 Quantity of 2</p> <div style="text-align: center; margin: 20px 0;">  </div> <p>Wheel</p>	<div style="text-align: center; margin: 20px 0;">  </div> <p>Allen Wrench</p>	<div style="text-align: center; margin: 20px 0;">  </div> <p>Open Wrench</p>

Part List

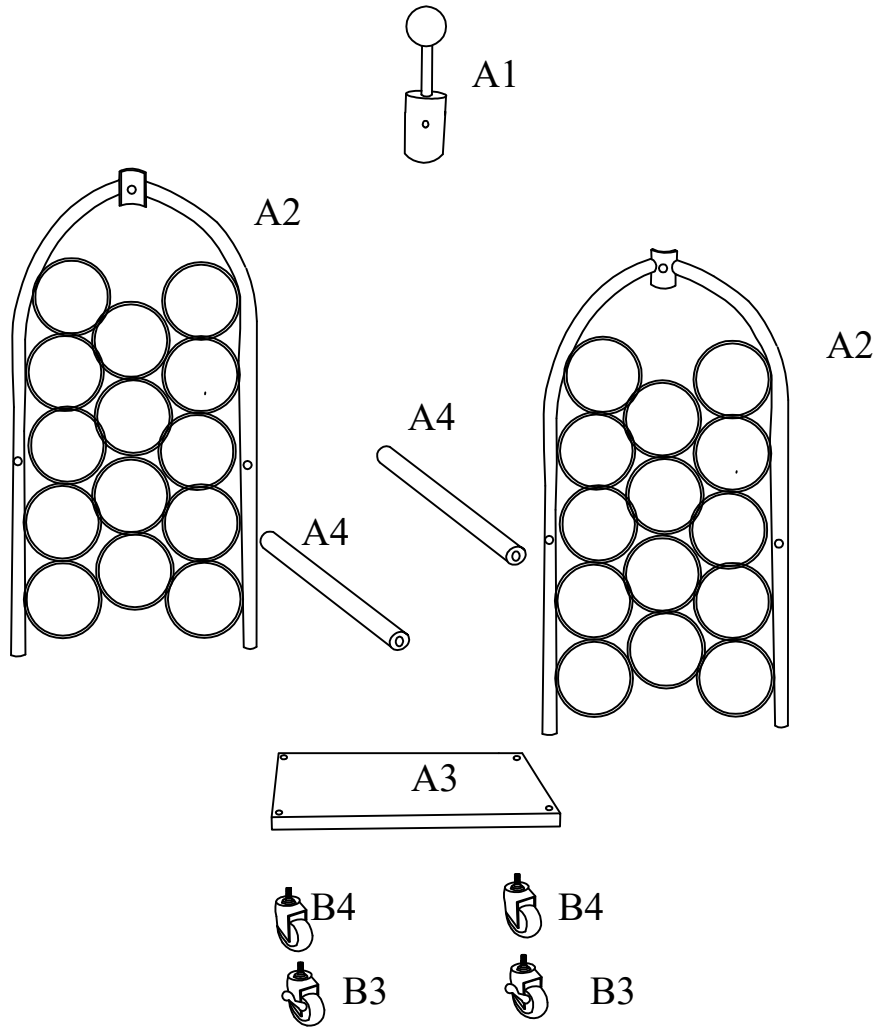

Step 1:

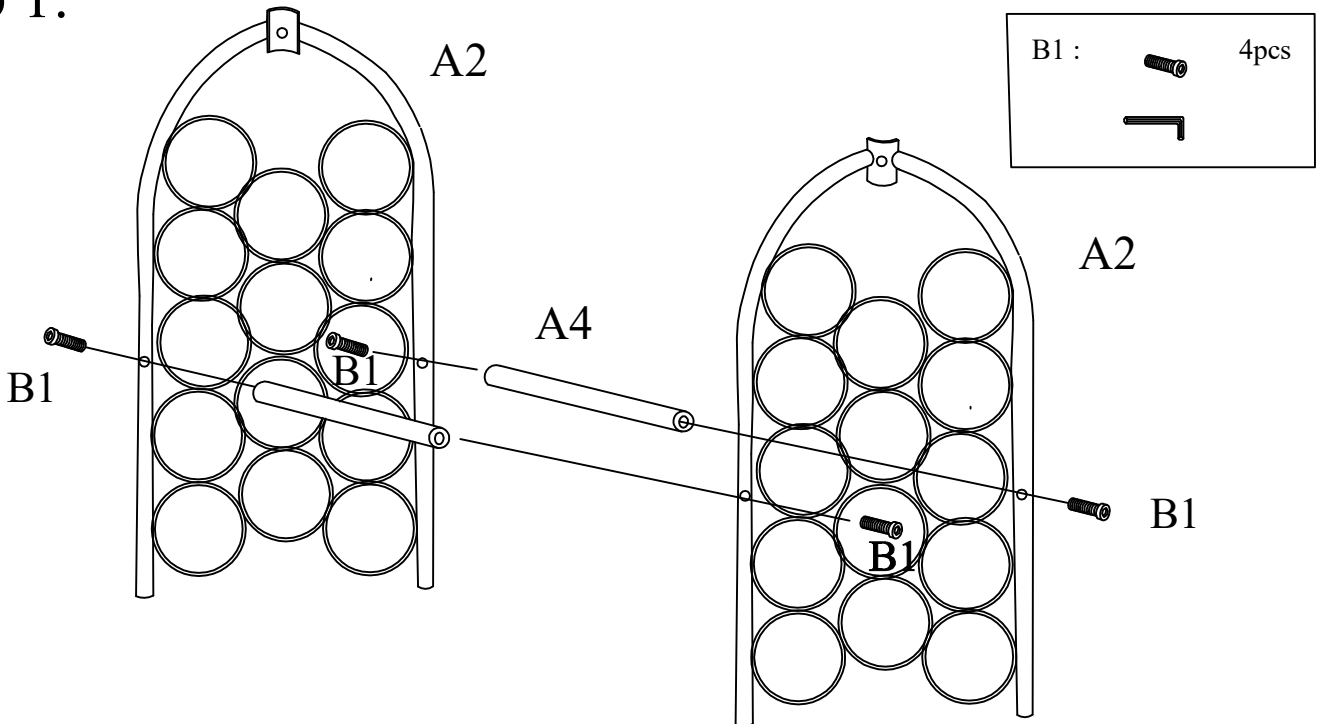

Assemble Side Frames A2 to Connect Bars A4 using Bolts B1 as shown above.
Note: Please do not tighten bolts B1 until Step 3.

Step 2:

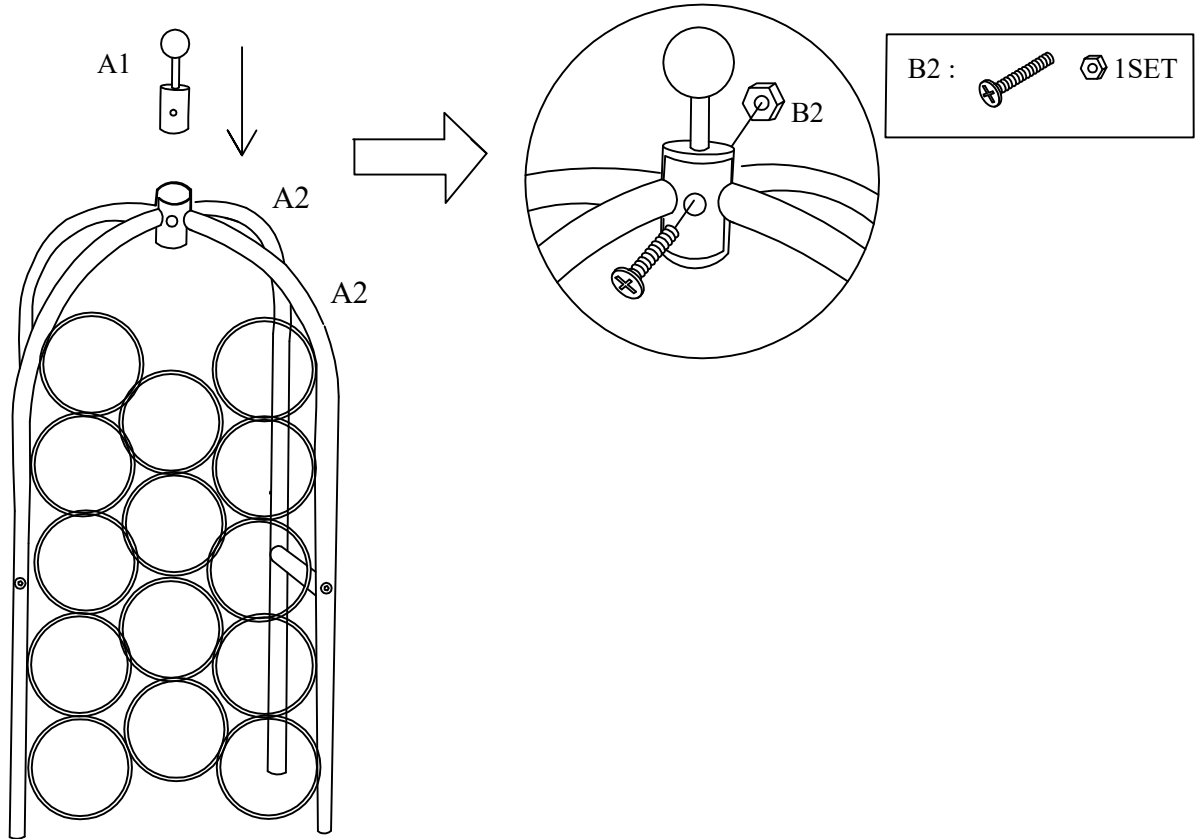

Insert Connect Block A1 into Side Frames A2 and tighten using Bolt with Nut B2 as shown above .
Note: Please do not tighten bolt B2 until Step 3.

Step 3

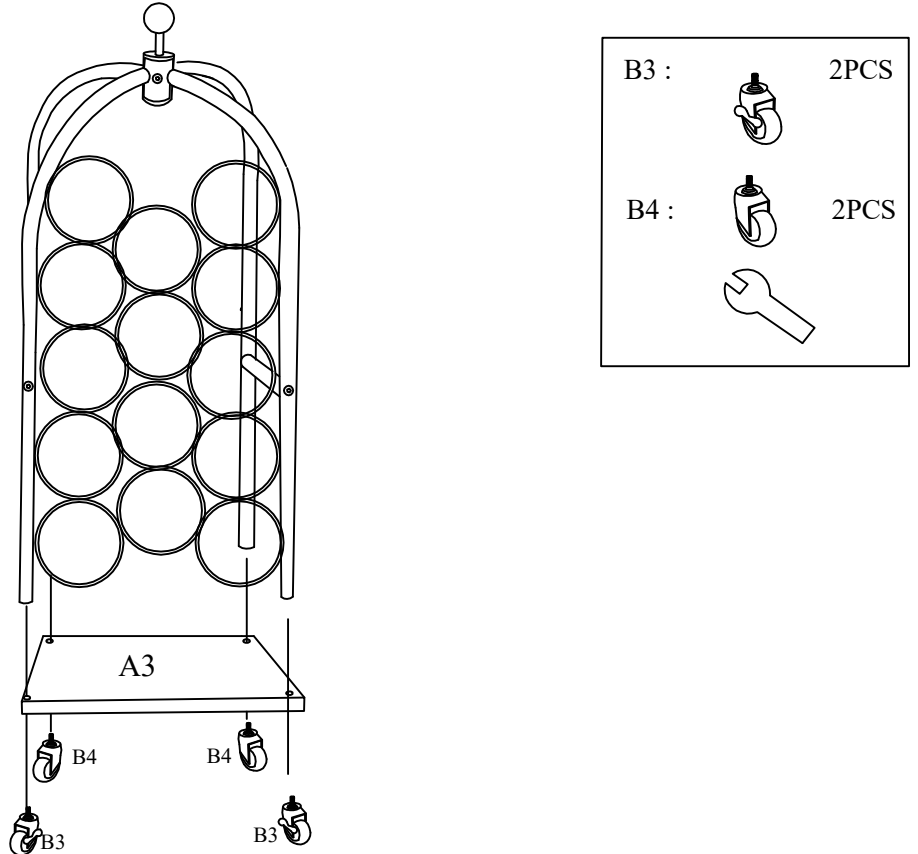

Assemble Bottom Panel A3 to Side Frames A2 using Wheels B3&B4 as shown above .
Place wine rack on the floor and check if it is stable before tightening all bolts.