

# ASSEMBLY INSTRUCTIONS

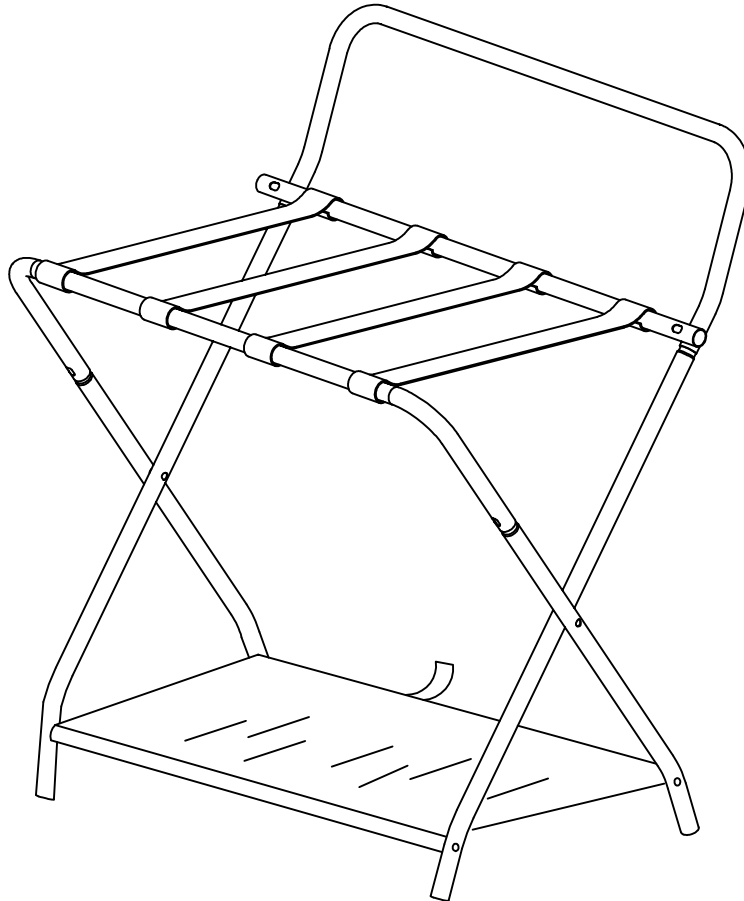



## Style# LRK168 Luggage Rack





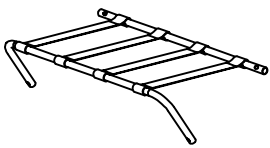
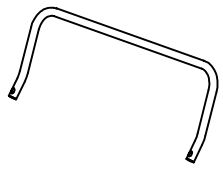

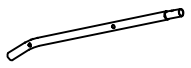

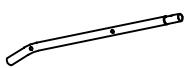
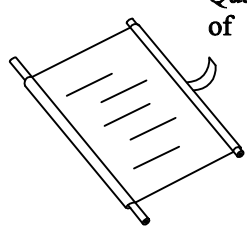
### NOTE TO CUSTOMERS:

- For ease and speed of assembly we recommend that before you commence each step of the assembly that you identify all the parts required to complete that step.
- We recommend that where possible you allow sufficient space to assemble the item as close as possible to the place where it will be once assembled.
- For the protection of your furniture we recommend that the product is placed on protected surfaces during assembly to prevent any damage.
- During assembly do not over tighten, as this may damage the product.
- Please ensure you retain all the product packaging until the item completely assembled.
- Please periodically check all fittings and re-tighten as necessary.
- Never allow any liquids to remain on your furniture as absorption can cause the wood to warp or the finish to de-laminate.
- It is recommended that this item should be assembled by two adults.

# Part List

<p>A1. <span style="float: right;">Quantity of 1</span></p>  <p>Upper Frame with belt</p>	<p>A2. <span style="float: right;">Quantity of 1</span></p>  <p>Holder</p>	<p>A3. <span style="float: right;">Quantity of 1</span></p>  <p>Leg</p>
<p>A4. <span style="float: right;">Quantity of 1</span></p>  <p>Leg</p>	<p>A5. <span style="float: right;">Quantity of 1</span></p>  <p>Leg</p>	<p>A6. <span style="float: right;">Quantity of 1</span></p>  <p>Leg</p>
<p>A7. <span style="float: right;">Quantity of 1</span></p>  <p>Shelf</p>		

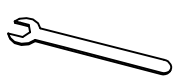

# Hardware List

<p>B1. <span style="float: right;">Quantity of 2</span></p>  <p>Bolt</p>	<p>B2. <span style="float: right;">Quantity of 2</span></p>  <p>Bolt</p>	<p>B3. <span style="float: right;">Quantity of 2</span></p>  <p>Nut</p>	<p>B4. <span style="float: right;">Quantity of 2</span></p>  <p>Washer</p>
<p>B5. <span style="float: right;">Quantity of 6</span></p>  <p>Bolt</p>	 <p>Allen Wrench</p>	 <p>Open Wrench</p>	

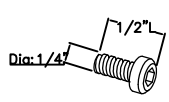
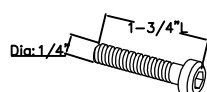
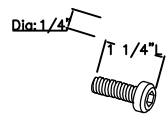
## APPENDIX: Dimension of Hardwares in this AI.

<p>B1.</p> 	<p>B2.</p> 	<p>B5.</p> 
--	--	--

# STEP 1

B2		2pcs
B3		2pcs
B4		2pcs

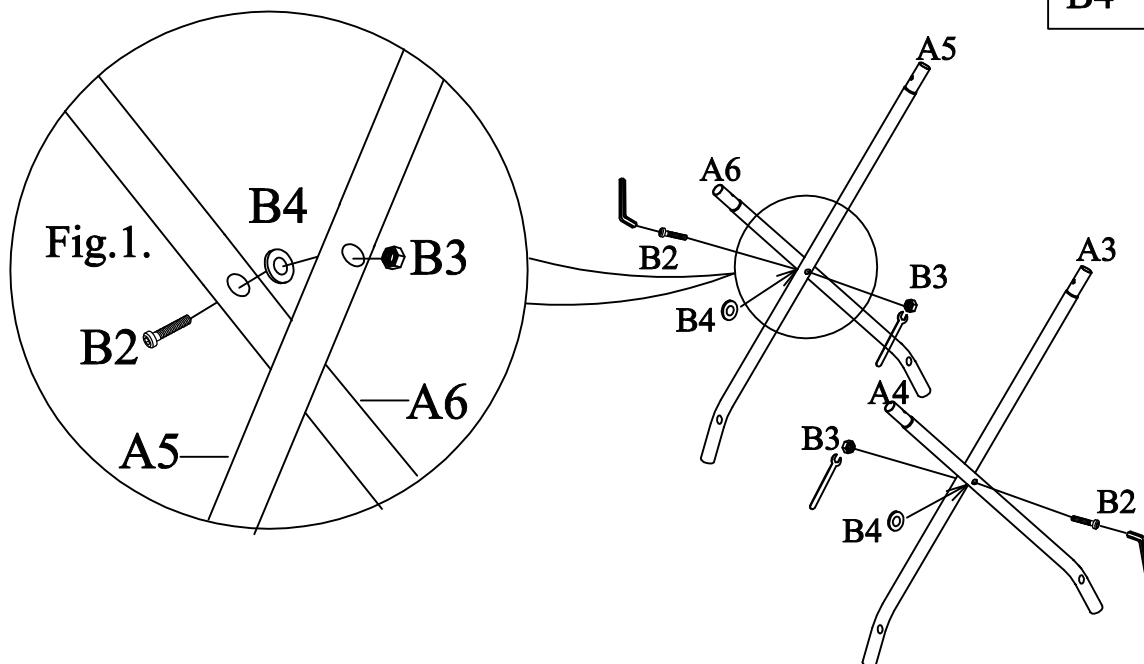

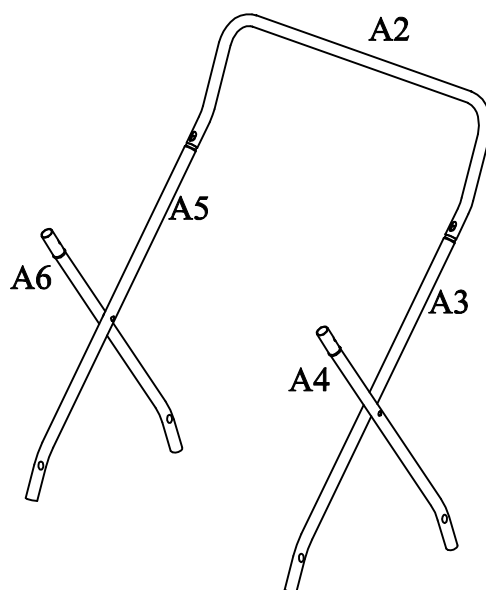

Assemble Legs A5&A6 using Bolt B2, Washer B4 & Nut B3 as shown above, please ensure washer B4 is inserted between Legs A5&A6, refer to Fig.1 (tighten bolts 90% at this point), Repeat above step to assemble Legs A3&A4.

# STEP 2



Insert Holder A2 into Legs A3&A5 as shown above.

## STEP 3

B1		2pcs
B5		2pcs

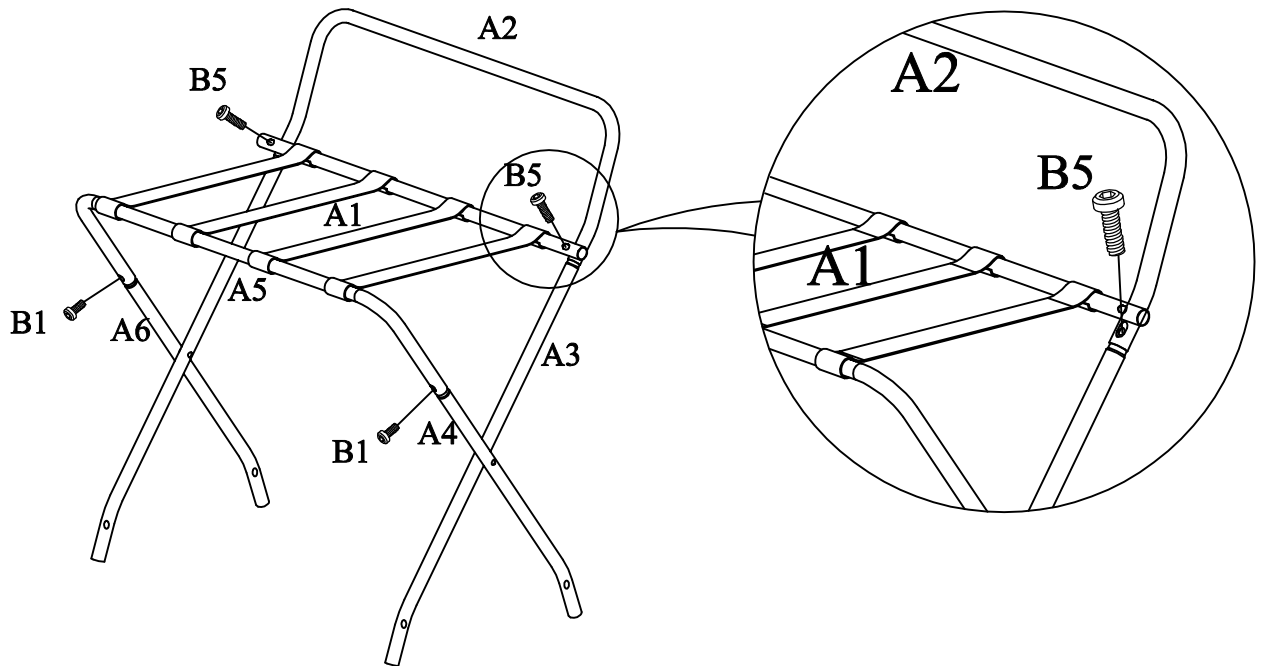

Insert Upper Frame A1 into Legs A4&A6 and tighten using Bolts B1, Then attach it to Holder A2 using bolts B5 as shown above.  
Please do not tighten bolts B1&B5 until step 4.

## STEP 4

B5		4pcs
----	---	------

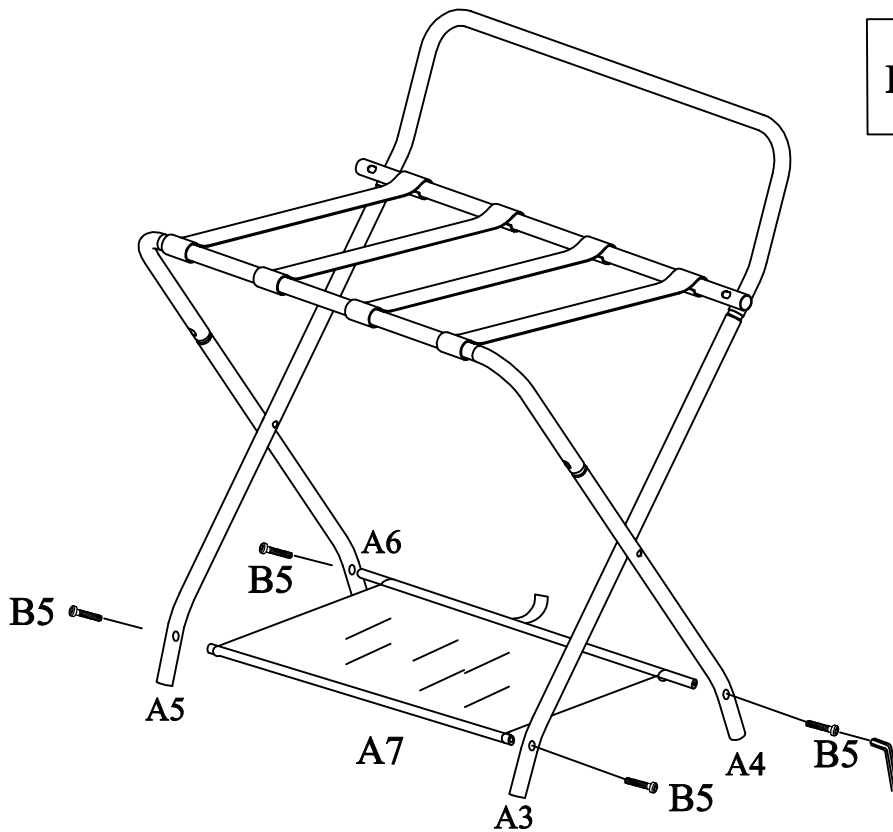

Assemble Shelf A7 to Legs A3&A4&A5&A6 using Bolt B5 as shown above.  
Place the rack on the floor and check if it is stable before tightening bolts B1&B5.