

# ASSEMBLY INSTRUCTIONS

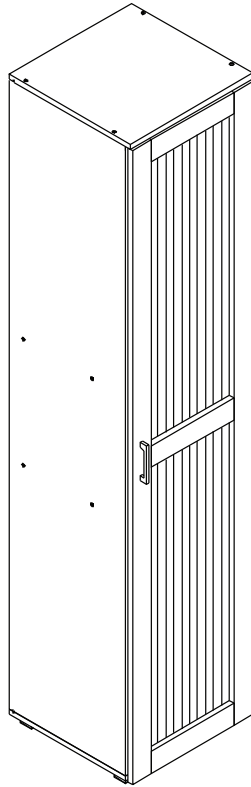





## MODEL : #CU6086 CURIO CABINET



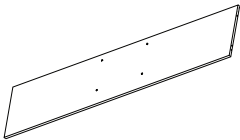
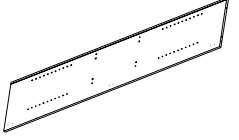
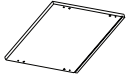
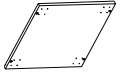
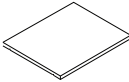

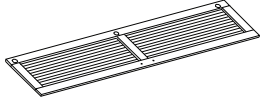

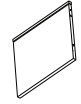

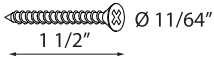
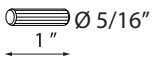
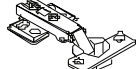
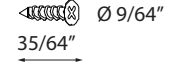

### NOTE TO CUSTOMERS:

- For ease and speed of assembly we recommend that before you commence each step of the assembly that you identify all the parts required to complete that step.
- We recommend that where possible you allow sufficient space to assemble the item as close as possible to the place where it will be once assembled.
- For the protection of your furniture we recommend that the product is placed on a dry, soft, smooth and clean surfaces during assembly to prevent any damage. Avoid damp and direct sunlight.
- During assembly do not over tighten the screws or bolts, as this may damage the product.
- Please ensure you retain all the product packaging until the item is completely assembled.
- Periodically check all fitting and re-tighten as necessary.
- Never allow any liquids to remain on your furniture as absorption can cause the wood to warp or finish to de-laminate.
- It is recommended that this item should be assembled by two adults.

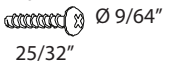
## PARTS IDENTIFICATION

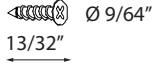
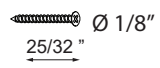
<p>① Quantity: 1</p>  <p>Side Panel Left</p>	<p>② Quantity: 1</p>  <p>Side Panel Right</p>	<p>③ Quantity: 1</p>  <p>Top Panel</p>	<p>④ Quantity: 1</p>  <p>Base Panel</p>	<p>⑤ Quantity: 2</p>  <p>Adjustable Shelf Panel</p>
<p>⑥ Quantity: 2</p>  <p>Upper &amp; Lower Back Panel</p>	<p>⑦ Quantity: 1</p>  <p>Door</p>	<p>⑧ Quantity: 1</p>  <p>Middle Back Panel</p>	<p>⑨ Quantity: 2</p>  <p>Fix shelf Panel</p>	<p><b>TOOLS REQUIRED</b></p>  <p>SCREW DRIVER</p>  <p>MALLET</p>

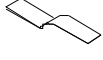
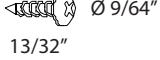
## HARDWARE LIST

<p>Ⓐ Screw #9 x 1 1/2"</p>  <p>Quantity: 16 pcs</p>	<p>Ⓑ Wooden Dowel M8 x 25</p>  <p>Quantity: 16 pcs</p>	<p>Ⓒ Hinges</p>  <p>Quantity: 3 pcs</p>	<p>Ⓓ Hinges Screw M3.5 x 14</p>  <p>Quantity: 12 pcs</p>	<p>Ⓔ Door Pull</p>  <p>Quantity: 1 pc</p>
<p>Ⓕ Door Pull Screw Pan Head #6 x 20</p>  <p>Quantity: 2 pcs</p>	<p>Ⓖ Leg</p>  <p>Quantity: 4 pcs</p>	<p>Ⓗ Leg's Screw M3.5 x 12</p>  <p>Quantity: 16 pcs</p>	<p>Ⓙ Corner Wedge Screw m3 x 20mm</p>  <p>Quantity: 8 pcs</p>	<p>Ⓝ Corner Wedge</p>  <p>Quantity: 8 pcs</p>
<p>Ⓚ Shelf support pin</p>  <p>Quantity: 8 pcs</p>	<p>Ⓛ Anti-tip strap</p>  <p>Quantity: 1 pc</p>	<p>Ⓜ Screw Panhead M3.5 x 12</p>  <p>Quantity: 1 pc</p>	<p>Ⓝ Flat washer</p>  <p>Quantity: 1 pc</p>	<p>Ⓞ Sticker</p>  <p>Quantity: 8 pcs</p>

### STEP 1

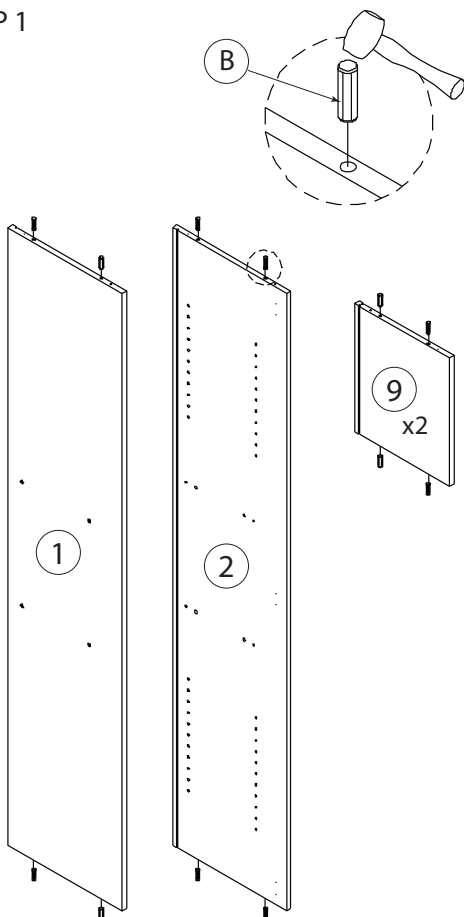

### STEP 2

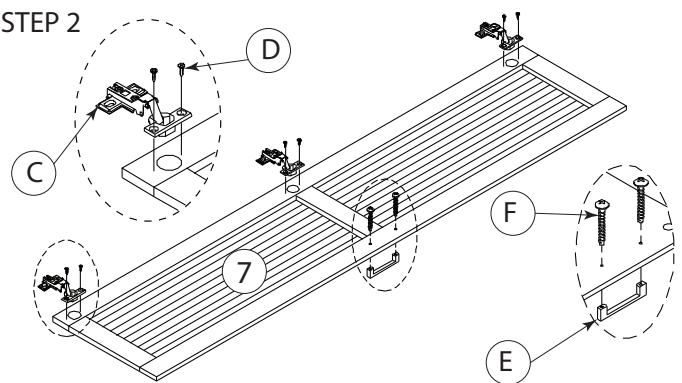

### STEP 3

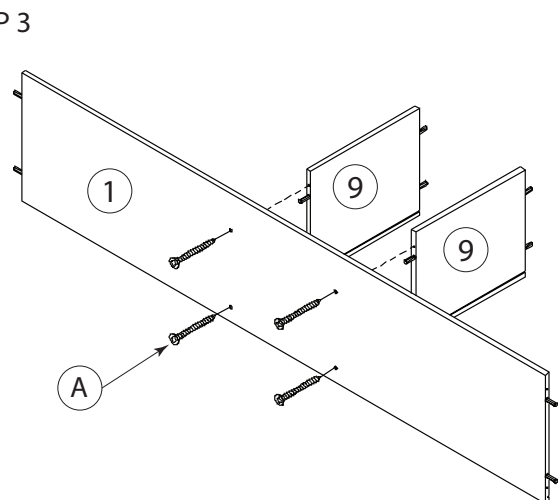

**STEP 4**

**STEP 9**

**STEP 5**

**STEP 10**

**STEP 6**

**STEP 11**

**STEP 12**

**STEP 7**

**STEP 8**

**STEP 13**

**Guideline of fixing the hinges**

A-Lateral adjustment by adjusting the screws in hinges arm.  
 B-Vertical adjustment by adjusting the screws in hinges arm.  
 C-Front to back by adjusting the sliding hinges and tighten it.

**LEG'S CAP**

**Install tip-over restraint provided, and mount it to the wall to avoid the risk of tip-over.**