

ASSEMBLY INSTRUCTIONS

Style # 1375WH-E &1375CH-E
Side Cabinet

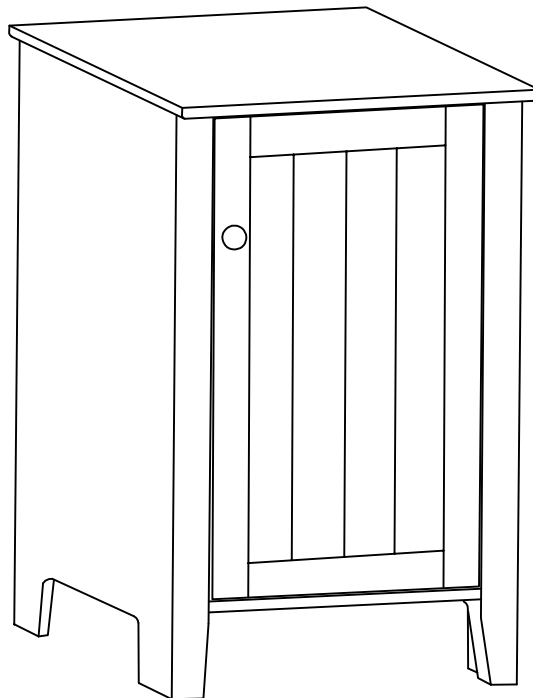

NOTE TO CUSTOMERS:

- For ease and speed of assembly we recommend that before you commence each step of the assembly that you identify all the parts required to complete that step.
- We recommend that where possible you allow sufficient space to assemble the item as close as possible to the place where it will be once assembled.
- For the protection of your furniture we recommend that the product is placed on protected surfaces during assembly to prevent any damage.
- During assembly do not over tighten ,as this may damage the product.
- Please ensure you retain all the product packaging until the item completely assembled.
- Please periodically check all fittings and re-tighten as necessary.
- Never allow any liquids to remain on your furniture as absorption can cause the wood to warp or the finish to de-laminate.
- It is recommended that this item should be assembled by two adults.

To insert a cam lock: (Please read below instructions before assembling)

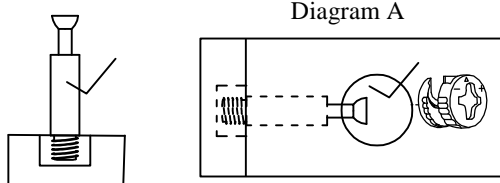

Diagram A

1. Insert cam screw into hole as shown in diagram A .

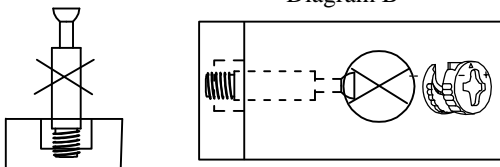

Diagram B

Make sure not to insert the cam screw:
Too deep as shown in figure B as this will cause the
cam screw to be misaligned and unable to
interlock properly.

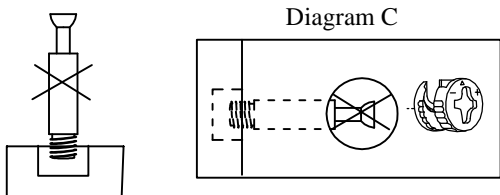
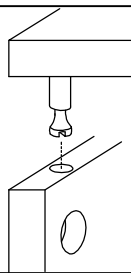
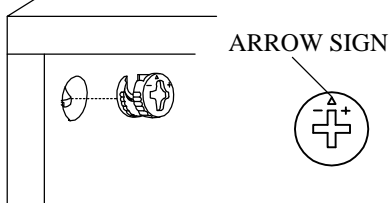

Diagram C

Also avoid inserting the cam screw too close to the
surface of the hole as shown in figure C, as this will
cause the cam lock to be too loose, and not interlock
properly.



2. Connect the panels together.



ARROW SIGN

3. When inserting the cam lock make sure the arrow
of the cam lock faces the cam screw.

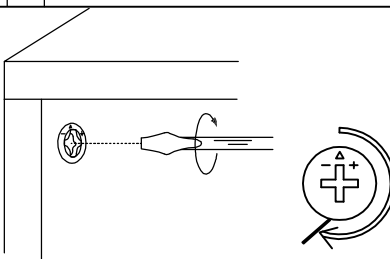



4. To tighten the cam lock turn the cam lock clockwise
90-180 degree or until the arrow is facing opposite
the place cam lock was inserted.

**NOTE: DO NOT USE AN AUTOMATIC
SCREWDRIVER TO TIGHTEN CAM LOCKS.**

Note:

- Read these instructions carefully before assembling.
- Tools required : Phillips screwdriver, flat screwdriver.
- Find a clean, smooth area on which to work , such as a carpet, in order to avoid scratching the wood surfaces.
- Wait to dispose of the packing material until assembly is complete and all parts and hardware are accounted for.
- Two or more people might be required for assembly.

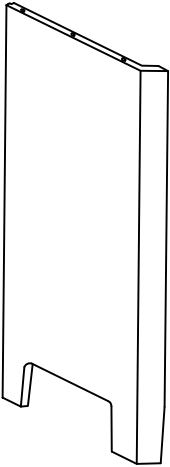
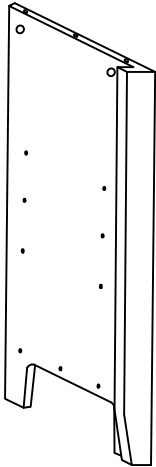
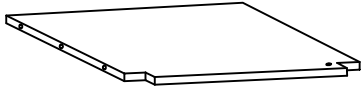

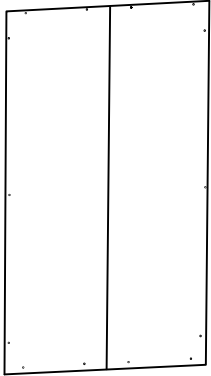
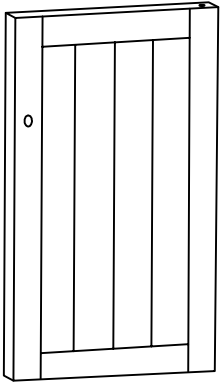

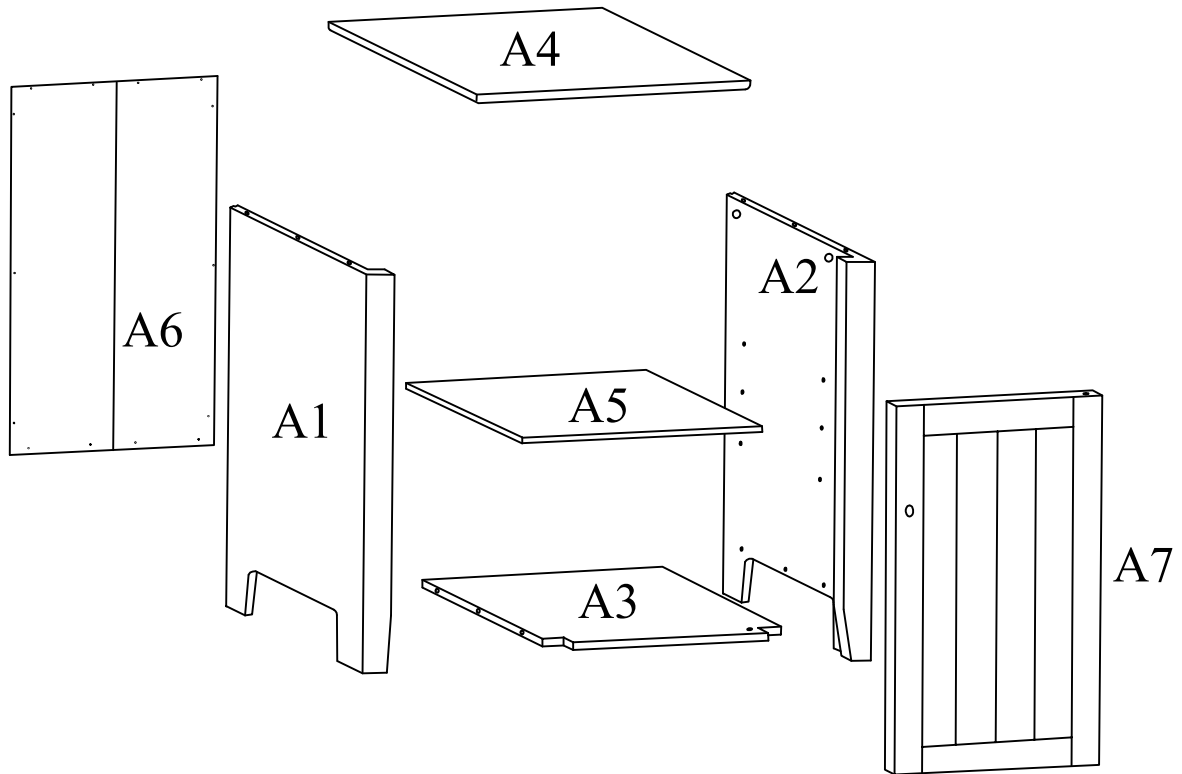

Part List

| | | |
|---|--|--|
| <p>A1</p> <p>Quantity of 1</p>  <p>Left Side Panel</p> | <p>A2</p> <p>Quantity of 1</p>  <p>Right Side Panel</p> | <p>A3</p> <p>Quantity of 1</p>  <p>Bottom Panel</p> |
| <p>A4</p> <p>Quantity of 1</p>  <p>Top Panel</p> | <p>A5</p> <p>Quantity of 1</p>  <p>Shelf Panel</p> | <p>A6</p> <p>Quantity of 1</p>  <p>Back Panel</p> |
| <p>A7</p> <p>Quantity of 1</p>  <p>Door</p> | | |

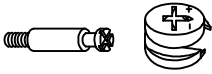
Part List

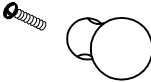

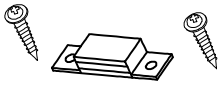

Hardware List

| | | | |
|--|---|--|--|
| <p>B1</p> <p style="text-align: center;">Quantity of 8</p> <div style="text-align: center;">  </div> <p>Camlock</p> | <p>B2</p> <p style="text-align: center;">Quantity of 4</p> <div style="text-align: center;">  <p>Ø1/4"*1.25"</p> </div> <p>Wood Dowel</p> | <p>B3</p> <p style="text-align: center;">Quantity of 1</p> <div style="text-align: center;">  </div> <p>Door Knob</p> | <p>B4</p> <p style="text-align: center;">Quantity of 14</p> <div style="text-align: center;">  </div> <p>Screw</p> |
| <p>B5</p> <p style="text-align: center;">Quantity of 2</p> <div style="text-align: center;">  </div> <p>Door Pin</p> | <p>B6</p> <p style="text-align: center;">Quantity of 1</p> <div style="text-align: center;">  </div> <p>Magnet with screw</p> | <p>B7</p> <p style="text-align: center;">Quantity of 4</p> <div style="text-align: center;">  </div> <p>Shelf Supporter</p> | |

Assembly instructions



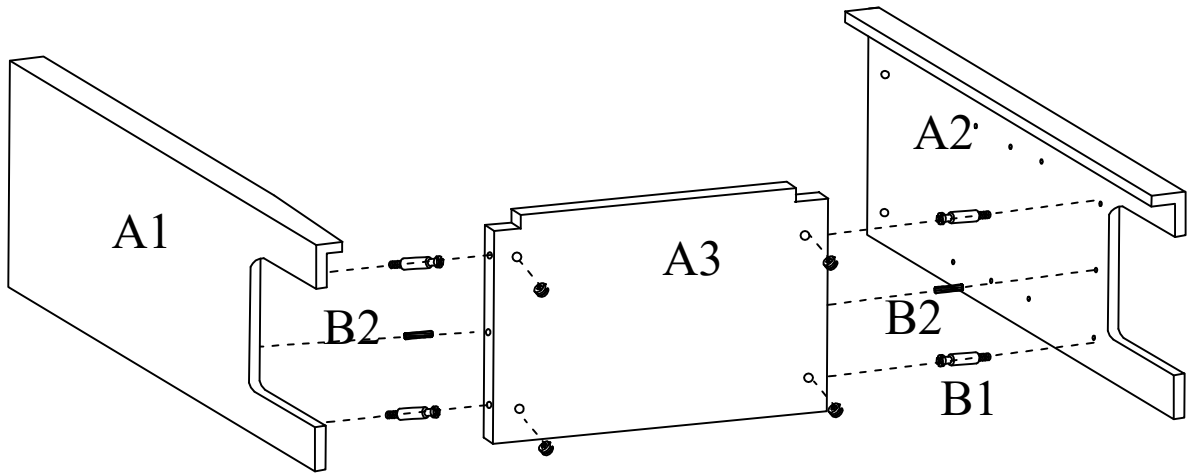

Step 1:

| | | | |
|----|---|---|-------|
| B1 |  |  | 4SETS |
| B2 |  | | 2PCS |



Assemble Side Panels A1 & A2 to Bottom Shelf A3 using Camlocks B1 & Wood Dowels B2 as shown above.

Step 2:

| | | | |
|----|---|---|-------|
| B1 |  |  | 4SETS |
| B2 |  | | 2PCS |
| B6 |  |  | 1SET |

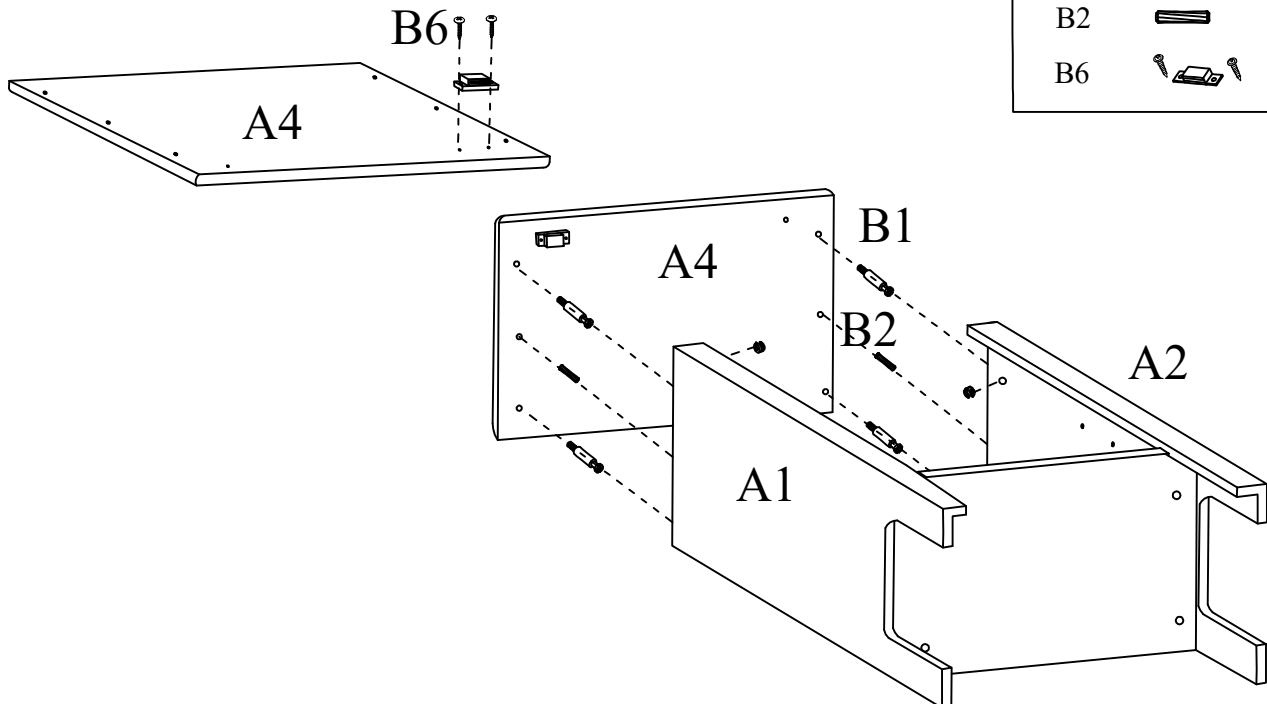

Attach Magnet B6 to the bottom of Top Panel A4 using included screws.
Then assemble Top Panel A4 to Side Panels A1 & A2 using Camlocks B1 & Wood Dowels B2 as shown above.

Step 3:

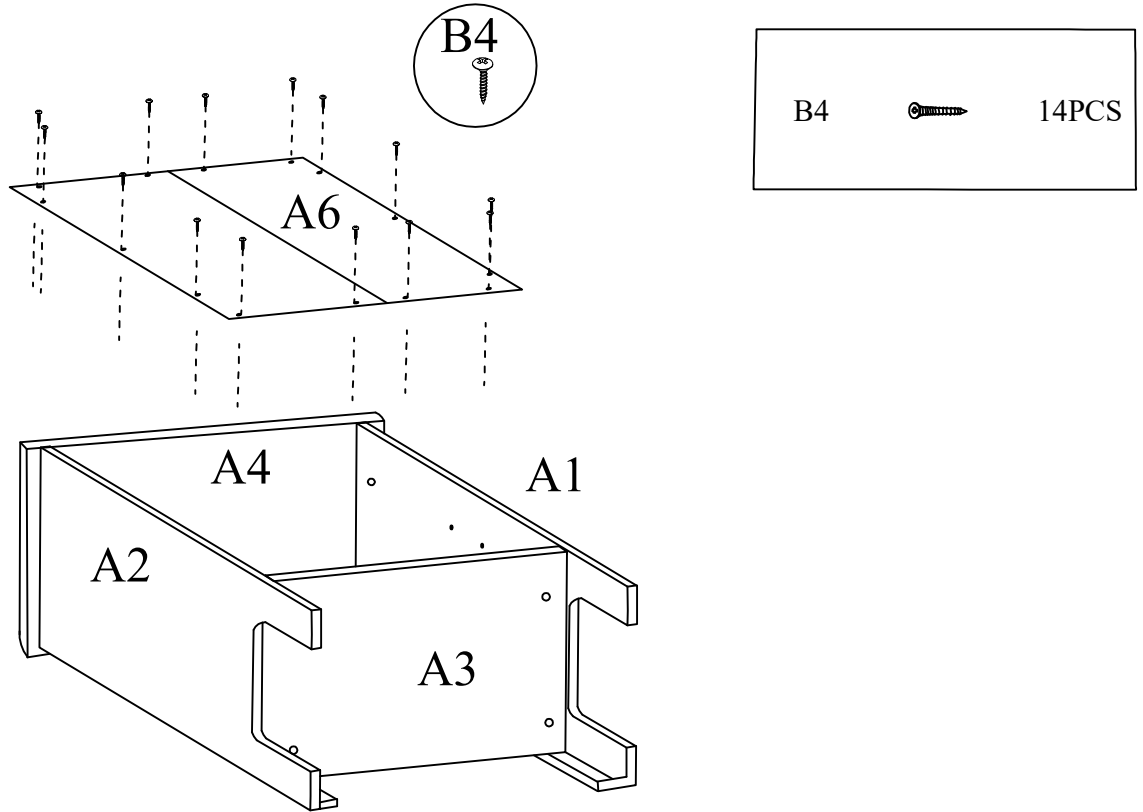

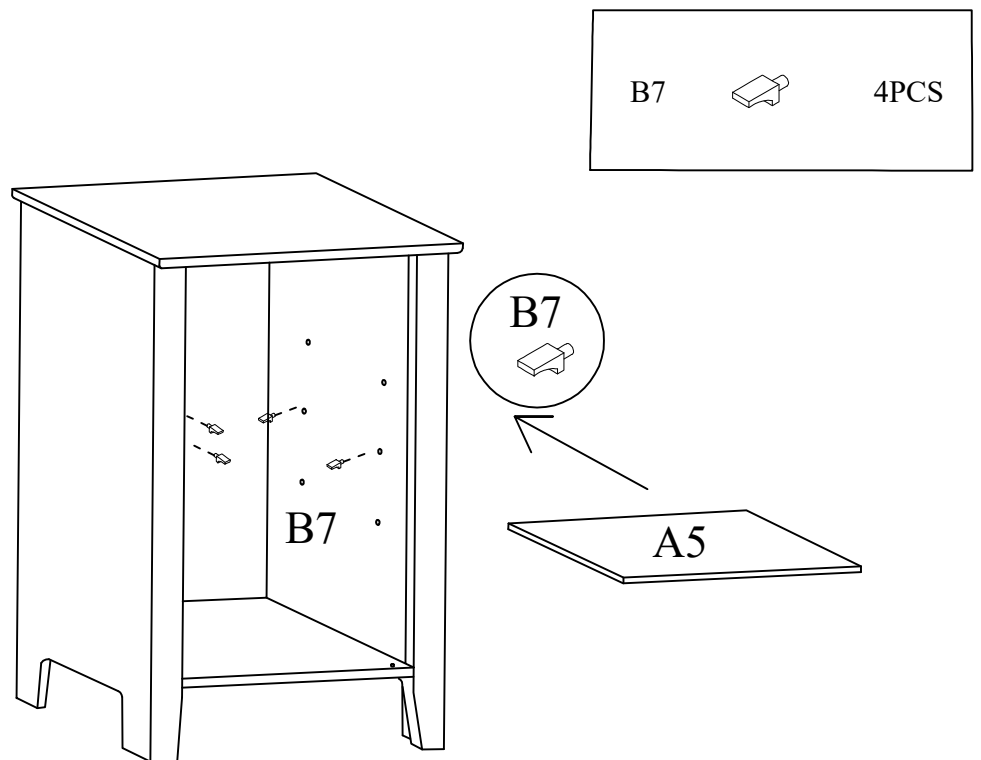

Assemble Back Panel A6 to the back of unit using Screws B4 as shown above.

Step 4:



Insert Shelf Supporters B7 into holes on Side Panels A1 & A 2, then place Shelf A5 onto the shelf supporters as shown above.

Step 5:

| | | |
|----|---|------|
| B5 |  | 2PCS |
| B3 |  | 1SET |

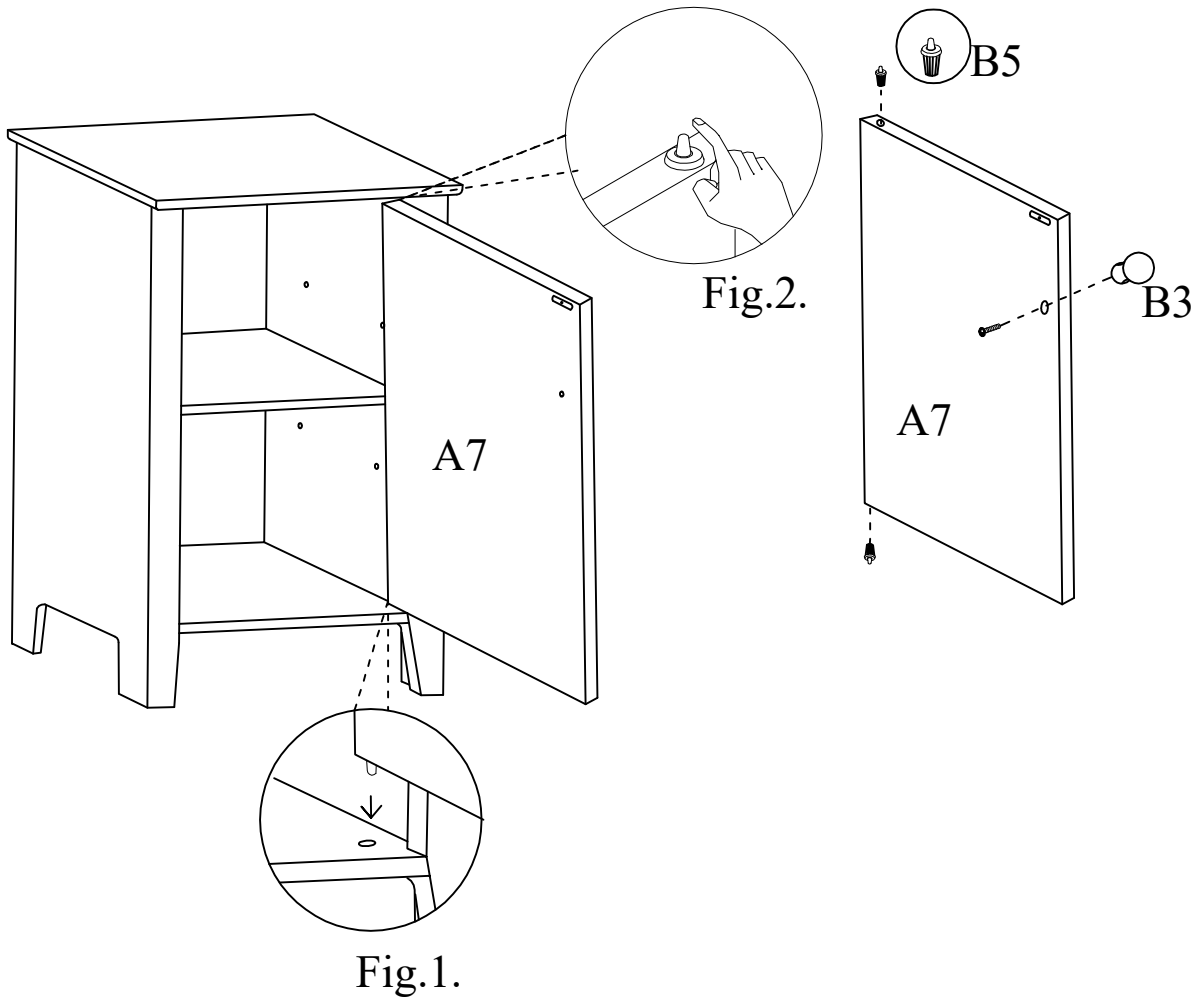

Insert Door Pin B5 into the holes on the two ends of Door A7. Then attach Door Knob B3 to Door using included bolts.
Attach and insert Door A7 to Bottom Panel A3, refer to Fig.1. Then press down Door Pin B5 ,see Fig.2. Then attach and insert door panel into Top Panel A4 with pin popping up into the hole, as shown above.