

# ASSEMBLY INSTRUCTIONS

Style # WR1369 Wine Rack

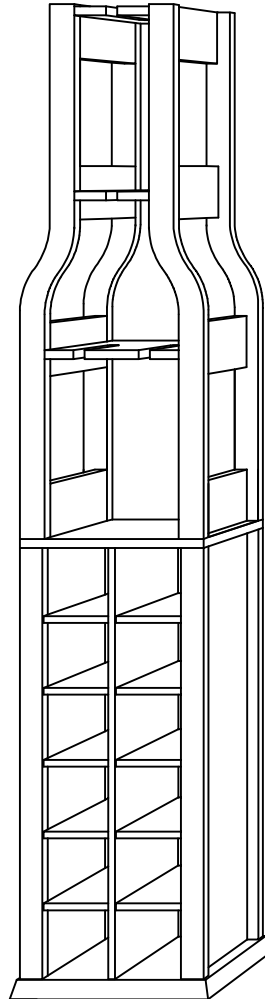

## NOTE TO CUSTOMERS:

- For ease and speed of assembly we recommend that before you commence each step of the assembly that you identify all the parts required to complete that step.
- We recommend that where possible you allow sufficient space to assemble the item as close as possible to the place where it will be once assembled.
- For the protection of your furniture we recommend that the product is placed on protected surfaces during assembly to prevent any damage.
- During assembly do not over tighten ,as this may damage the product.
- Please ensure you retain all the product packaging until the item completely assembled.
- Please periodically check all fittings and re-tighten as necessary.
- Never allow any liquids to remain on your furniture as absorption can cause the wood to warp or the finish to de-laminate.
- It is recommended that this item should be assembled by two adults.

## To insert a cam lock: (Please read below instructions before assembling)

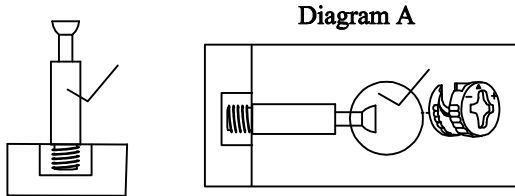

1. Insert cam screw into hole as shown in diagram A .

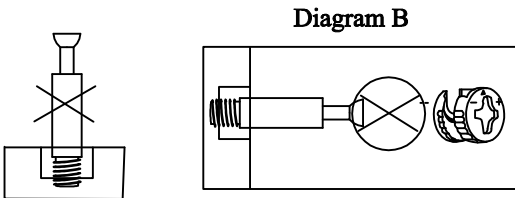

Make sure not to insert the cam screw:  
Too deep as shown in figure B as this will cause the  
cam screw to be misaligned and unable to  
interlock properly.

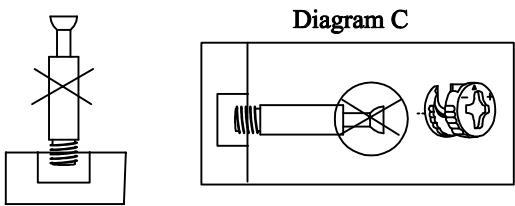

Also avoid inserting the cam screw too close to the  
surface of the hole as shown in figure C, as this will  
cause the cam lock to be too loose, and not interlock  
properly.

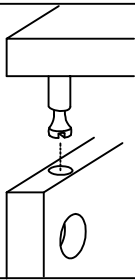

2. Connect the panels together.

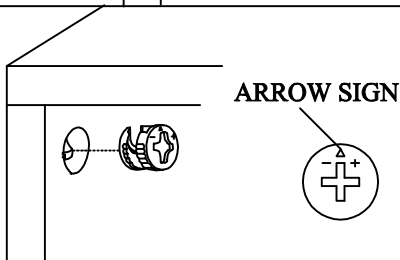

3. When inserting the cam lock make sure the arrow  
of the cam lock faces the cam screw.

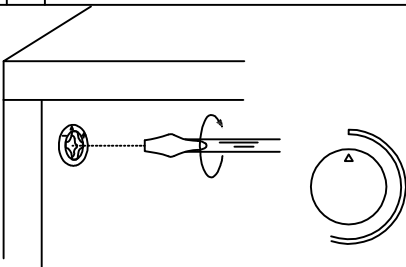







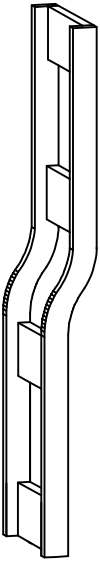
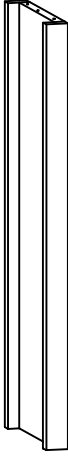
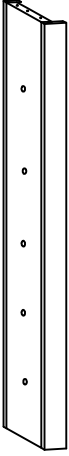

4. To tighten the cam lock turn the cam lock clockwise  
90-180 degree or until the arrow is facing opposite  
the place cam lock was inserted.

**NOTE: DO NOT USE AN AUTOMATIC  
SCREWDRIVER TO TIGHTEN CAM LOCKS.**

### Note:

- Read these instructions carefully before assembling.
- Tools required : Phillips screwdriver, flat screwdriver.
- Find a clean, smooth area on which to work , such as a carpet, in order to avoid scratching the wood surfaces.
- Wait to dispose of the packing material until assembly is complete and all parts and hardware are accounted for.
- Two or more people might be required for assembly.

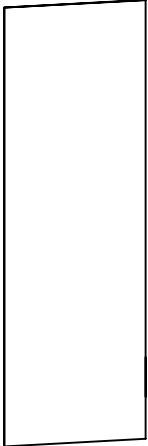



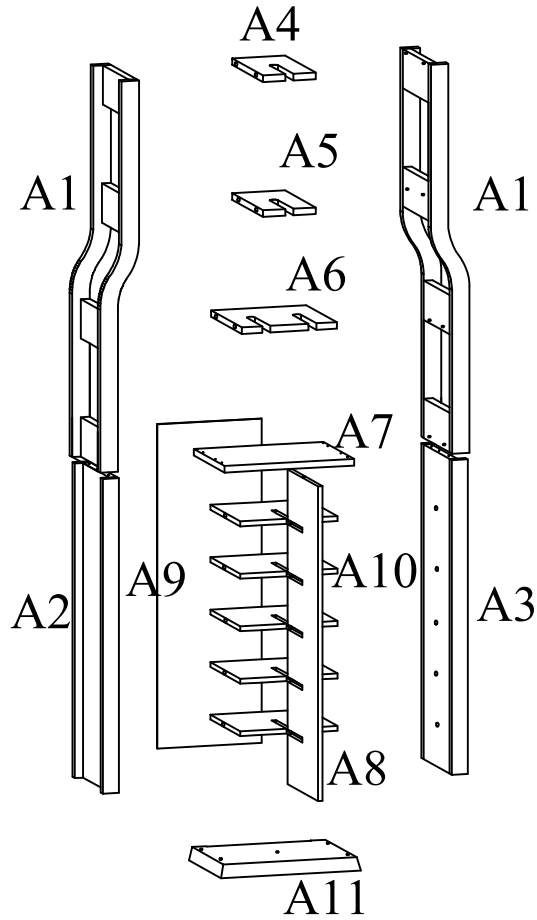

# Part List

|                                                                                                                                                             |                                                                                                                                                              |                                                                                                                                                                |
|-------------------------------------------------------------------------------------------------------------------------------------------------------------|--------------------------------------------------------------------------------------------------------------------------------------------------------------|----------------------------------------------------------------------------------------------------------------------------------------------------------------|
| <p><b>A1</b>  <b>Quantity of 2</b></p> <p><b>Upper Side Panel</b></p>      | <p><b>A2</b>  <b>Quantity of 1</b></p> <p><b>Lower Left Side Panel</b></p>  | <p><b>A3</b>  <b>Quantity of 1</b></p> <p><b>Lower Right Side Panel</b></p> |
| <p><b>A4</b>  <b>Quantity of 1</b></p> <p><b>Upper Support Shelf</b></p> | <p><b>A5</b>  <b>Quantity of 1</b></p> <p><b>Middle Support Shelf</b></p> | <p><b>A6</b>  <b>Quantity of 1</b></p> <p><b>Lower Support Shelf</b></p>  |
| <p><b>A7</b>  <b>Quantity of 1</b></p> <p><b>Middle Shelf</b></p>        | <p><b>A8</b>  <b>Quantity of 1</b></p> <p><b>Large Cross Panel</b></p>    | <p><b>A9</b>  <b>Quantity of 1</b></p> <p><b>Back Panel</b></p>           |
| <p><b>A10</b>  <b>Quantity of 5</b></p> <p><b>Small Cross Panel</b></p>  | <p><b>A11</b>  <b>Quantity of 1</b></p> <p><b>Bottom Panel</b></p>        |                                                                                                                                                                |

# Part List

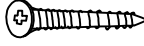

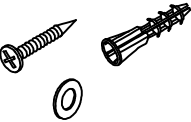
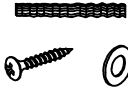
# Hardware List

|                                                                                                                                                                                                                         |                                                                                                                                                                                                                                        |                                                                                                                                                                                                                         |                                                                                                                                                                                                                          |
|-------------------------------------------------------------------------------------------------------------------------------------------------------------------------------------------------------------------------|----------------------------------------------------------------------------------------------------------------------------------------------------------------------------------------------------------------------------------------|-------------------------------------------------------------------------------------------------------------------------------------------------------------------------------------------------------------------------|--------------------------------------------------------------------------------------------------------------------------------------------------------------------------------------------------------------------------|
| <p>B1</p> <p style="text-align: center;">Quantity<br/>of 12</p> <div style="text-align: center;">  </div> <p><b>Camlock</b></p>      | <p>B2</p> <p style="text-align: center;">Quantity<br/>of 18</p> <div style="text-align: center;">  <p>14"*1.25"</p> </div> <p><b>Wood Dowel</b></p> | <p>B3</p> <p style="text-align: center;">Quantity<br/>of 4</p> <div style="text-align: center;">  </div> <p><b>Screw</b></p>        | <p>B4</p> <p style="text-align: center;">Quantity<br/>of 10</p> <div style="text-align: center;">  </div> <p><b>Screw</b></p>       |
| <p>B5</p> <p style="text-align: center;">Quantity<br/>of 4</p> <div style="text-align: center;">  </div> <p><b>Bolt with Nut</b></p> | <p>B6</p> <p style="text-align: center;">Quantity<br/>of 1</p> <div style="text-align: center;">  </div> <p><b>Anchor with Screw</b></p>            | <p>B7</p> <p style="text-align: center;">Quantity<br/>of 1</p> <div style="text-align: center;">  </div> <p><b>Anti-tip Kit</b></p> | <p>B8</p> <p style="text-align: center;">Quantity<br/>of 1</p> <div style="text-align: center;">  </div> <p><b>Allen Wrench</b></p> |
|                                                                                                                                                                                                                         |                                                                                                                                                                                                                                        |                                                                                                                                                                                                                         |                                                                                                                                                                                                                          |

# Assembly instructions

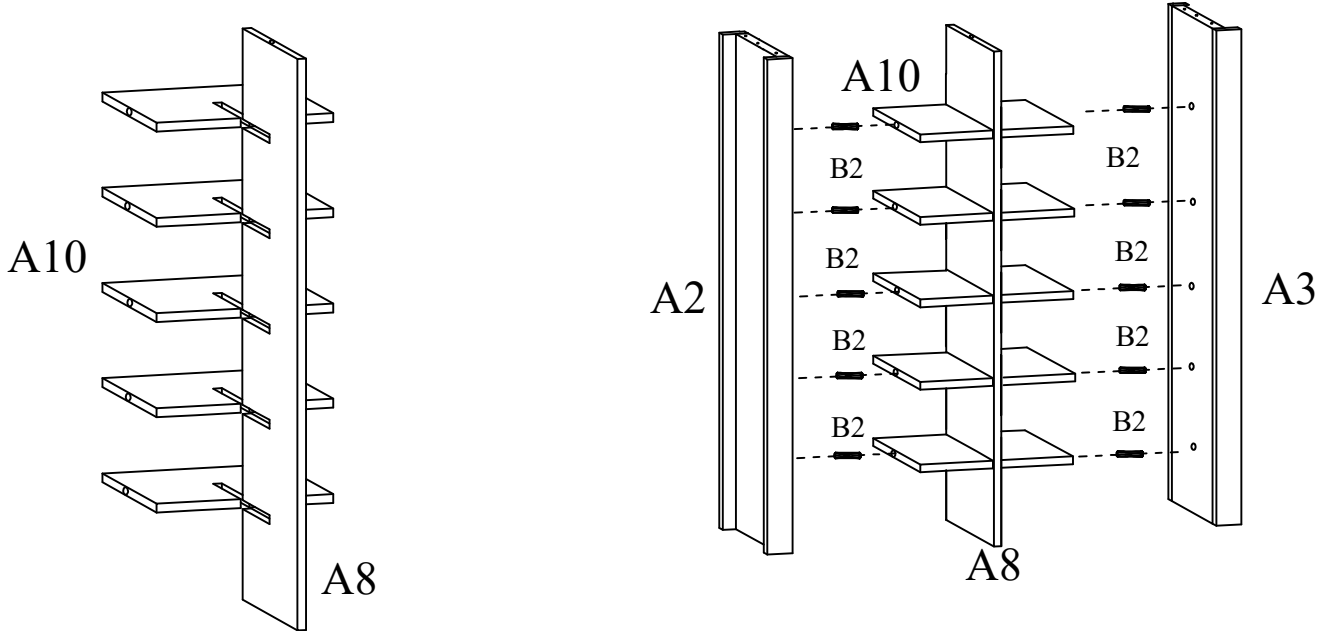

## Step 1:

|    |                                                                                     |       |
|----|-------------------------------------------------------------------------------------|-------|
| B2 |  | 10PCS |
|----|-------------------------------------------------------------------------------------|-------|



Attach Small Cross Panels A10 to Large Cross Panel A8, then assemble Lower Side Panels A2&A3 to Small Cross Panels A10 using Wood Dowels B2 as shown above.

## Step 2:

|    |                                                                                       |       |
|----|---------------------------------------------------------------------------------------|-------|
| B2 |  | 4PCS  |
| B3 |  | 4PCS  |
| B5 |  | 4SETS |

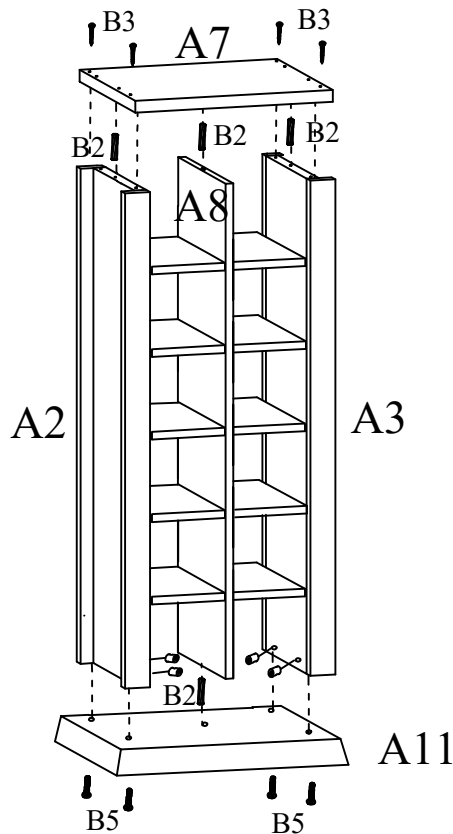

Assemble Middle Shelf A7 and Bottom Panel A11 to Large Cross Panel A8 and Lower Side Panels A2&A3 using Wood Dowels B2, Screws B3 and Bolts with Nuts B5 as shown above.

### Step 3:

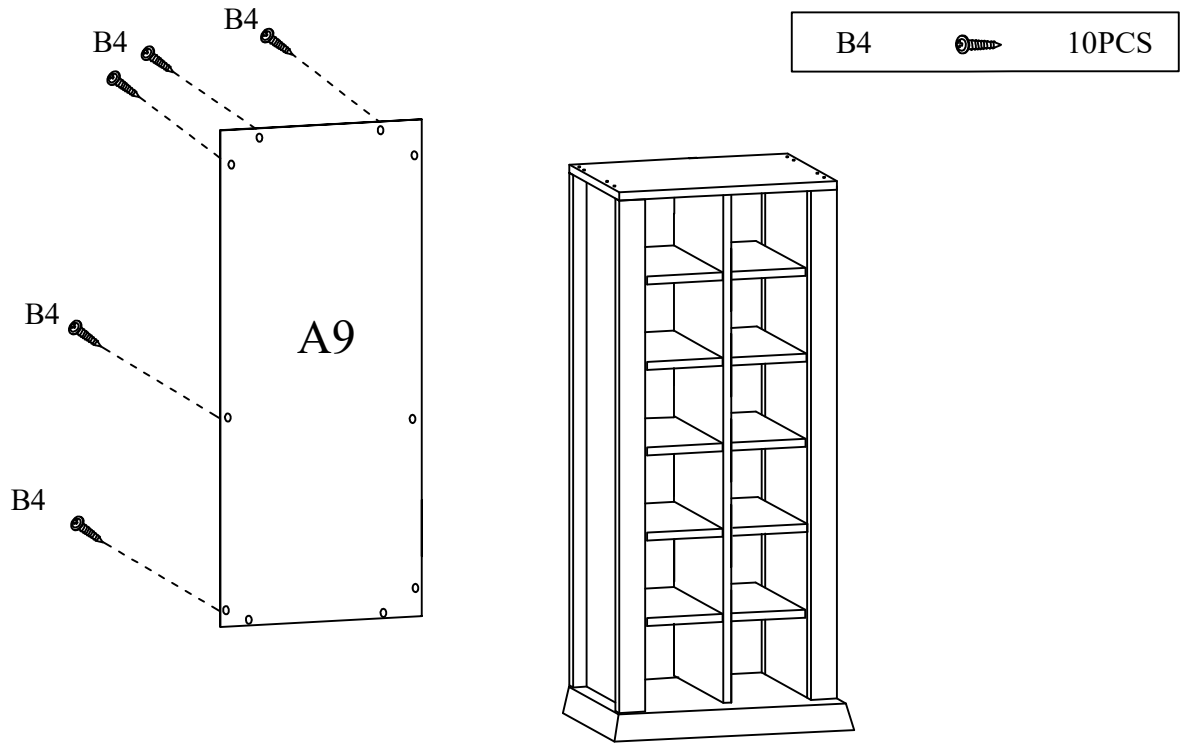

Attach Back Panel A9 to the back of this wine rack using Screws B4.

### Step 4:

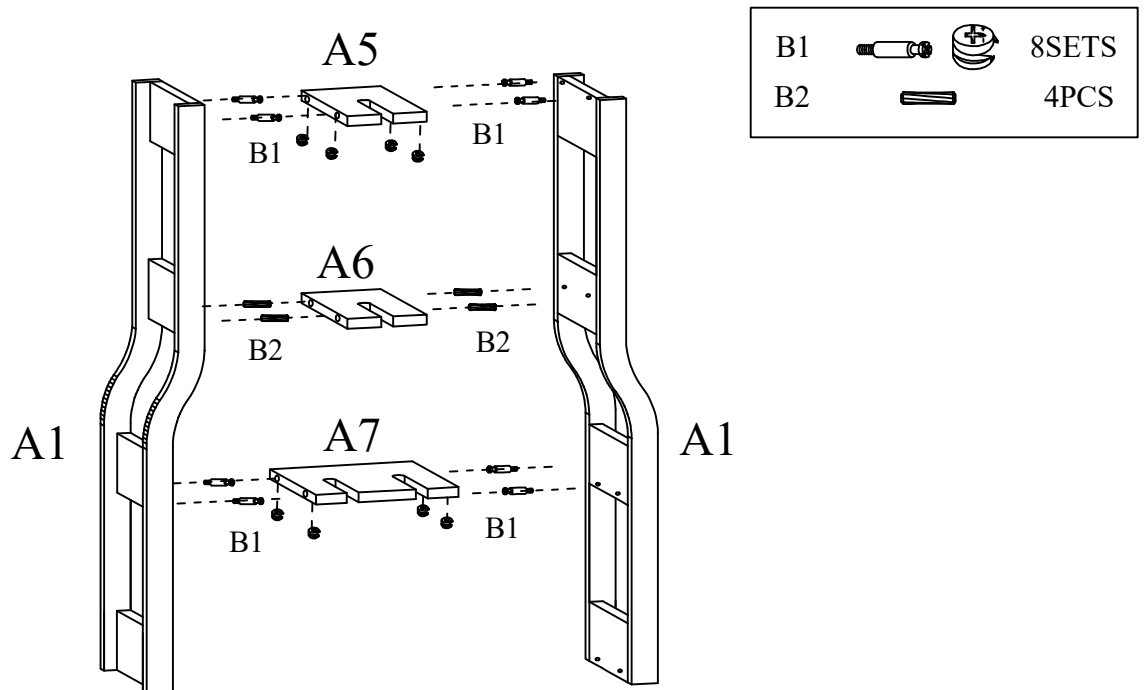

Assemble Upper Side Panels A1 to Support shelves A5&A6&A7 using Cam-Locks B1 and Wood Dowels B2 as shown above.

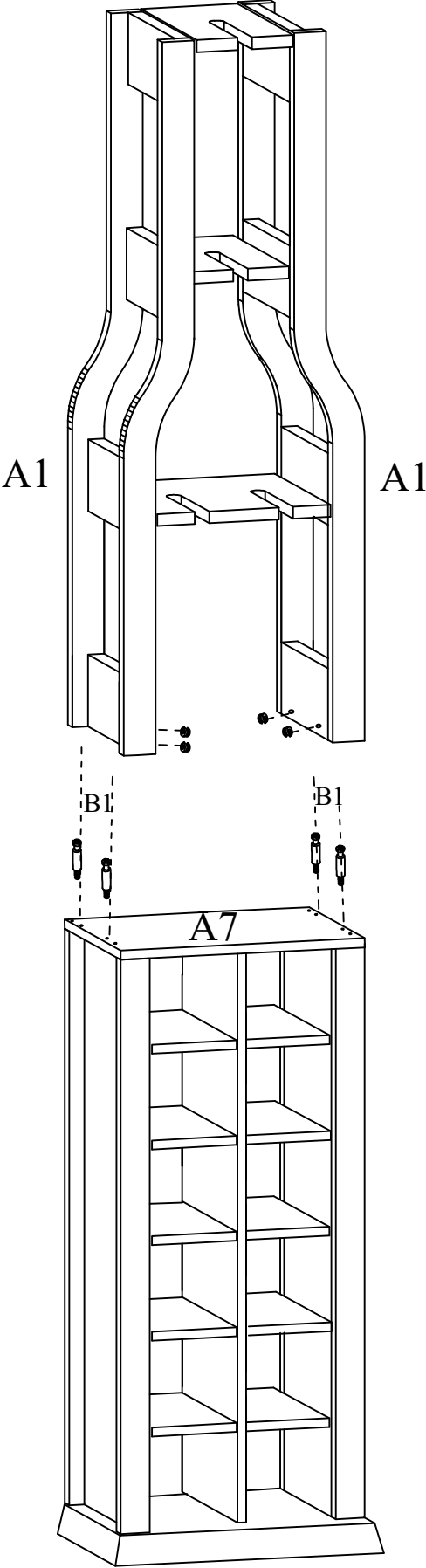

Step 5:

B1   4SETS



Assemble Upper Side Panels A1 to Middle Shelf A7 using Cam-Locks B1 as shown above.

# Step 6:

|    |                                                                                     |      |
|----|-------------------------------------------------------------------------------------|------|
| B6 |  | 1SET |
| B7 |  | 1SET |

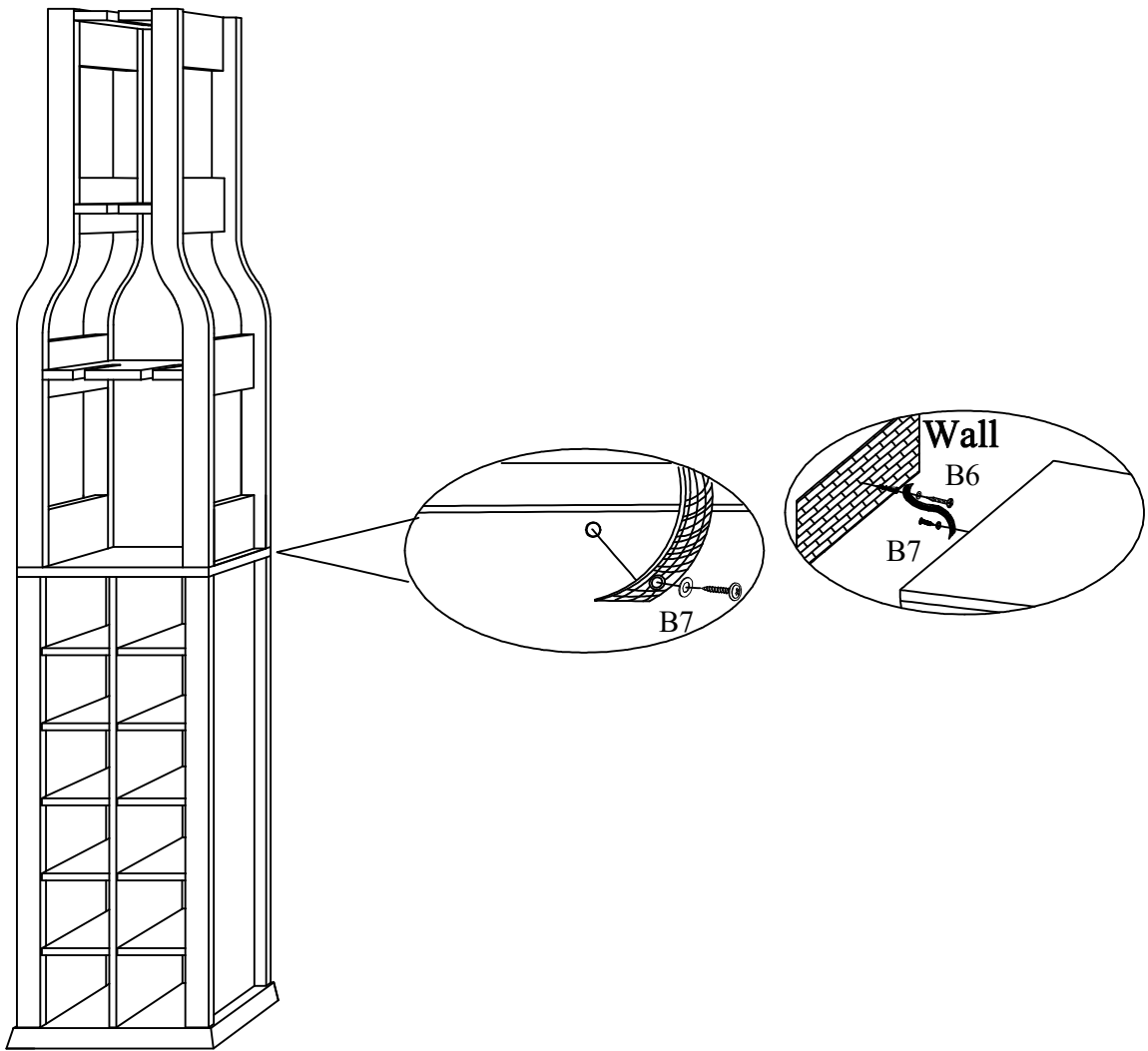

For your safety, please attach this unit to the wall by Anti-tip kit B7 and Wall Anchor with Screw B6.