

ASSEMBLY INSTRUCTIONS

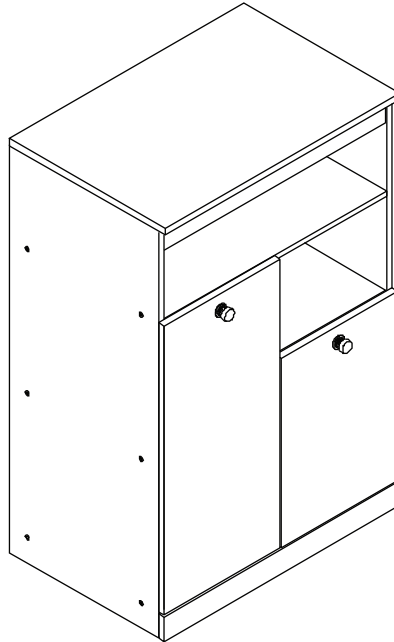



MODEL : #SR6044 SHOE CABINET





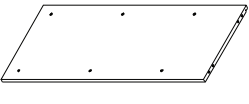
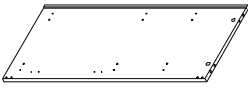
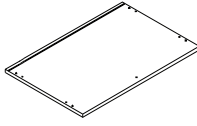
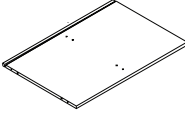
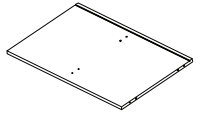

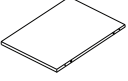

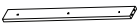
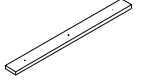
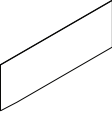
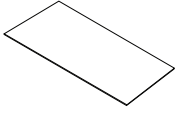
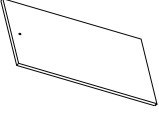
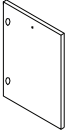

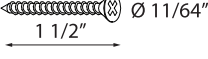

NOTE TO CUSTOMERS:

- For ease and speed of assembly we recommend that before you commence each step of the assembly that you identify all the parts required to complete that step.
- We recommend that where possible you allow sufficient space to assemble the item as close as possible to the place where it will be once assembled.
- For the protection of your furniture we recommend that the product is placed on a dry, soft, smooth and clean surfaces during assembly to prevent any damage. Avoid damp and direct sunlight.
- During assembly do not over tighten the screws or bolts, as this may damage the product.
- Please ensure you retain all the product packaging until the item is completely assembled.
- Periodically check all fitting and re-tighten as necessary.
- Never allow any liquids to remain on your furniture as absorption can cause the wood to warp or finish to de-laminate.
- It is recommended that this item should be assembled by two adults.

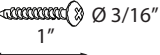
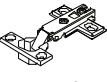
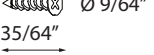
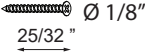
PARTS IDENTIFICATION

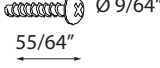
<p>① Quantity: 1</p>  <p>Side Panel Left</p>	<p>② Quantity: 1</p>  <p>Side Panel Right</p>	<p>③ Quantity: 1</p>  <p>Top Panel</p>	<p>④ Quantity: 1</p>  <p>Middle Shelf Panel</p>	<p>⑤ Quantity: 1</p>  <p>Base Panel</p>
<p>⑥ Quantity: 1</p>  <p>Center Panel</p>	<p>⑦ Quantity: 2</p>  <p>Shelve Panel</p>	<p>⑧ Quantity: 1</p>  <p>Apron Rail</p>	<p>⑨ Quantity: 1</p>  <p>Bottom Rail</p>	<p>⑩ Quantity: 1</p>  <p>Bottom Sub-rail</p>
<p>⑪ Quantity: 1</p>  <p>Upper Back Panel</p>	<p>⑫ Quantity: 2</p>  <p>Lower Back Panel</p>	<p>⑬ Quantity: 1</p>  <p>Larger Door</p>	<p>⑭ Quantity: 1</p>  <p>Smaller Door</p>	

HARDWARE LIST

<p>A Connecting Bolts</p>  <p>Quantity: 7 pcs</p>	<p>B Camlocks D15 x12.5mm</p>  <p>Quantity: 4 pcs</p>	<p>C Camlocks D15 x 9.5mm</p>  <p>Quantity: 3 pcs</p>	<p>D Screw #9 x 1 1/2"</p>  <p>Quantity: 18 pcs</p>	<p>E Wooden Dowel M6 x 25</p>  <p>Quantity: 32 pcs</p>
<p>F Panhead Tapping Screw #10 x 1"</p>  <p>Quantity: 3 pcs</p>	<p>G Hinges</p>  <p>Quantity: 4 pcs</p>	<p>H Hinges Screw M3.5 x 14</p>  <p>Quantity: 16 pcs</p>	<p>I Corner Wedge Screw m3 x 20mm</p>  <p>Quantity: 6 pcs</p>	<p>J Corner Wedge</p>  <p>Quantity: 6 pcs</p>
<p>K Door Pull</p>  <p>Quantity: 2 pcs</p>	<p>L Door Pull Screw Pan Head #6 x 22</p>  <p>Quantity: 2 pcs</p>	<p>M Leg Stud</p>  <p>Quantity: 5 pcs</p>	<p>N Sticker</p>  <p>Quantity: 16 pcs</p>	<p>TOOLS REQUIRED</p>  <p>SCREW DRIVER</p>  <p>MALLET</p>

STEP 1

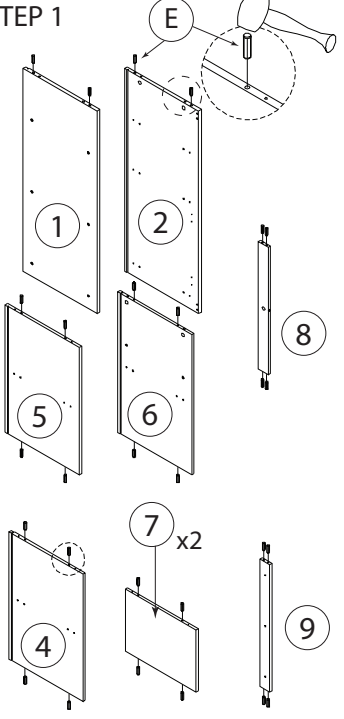

Inserting Wooden Dowels

STEP 2

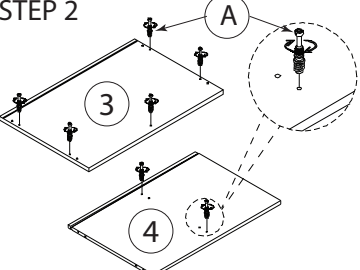

Align the Connecting Bolts.

STEP 3 Align the Camlock 'C' & turn it to locked position when it is connected to the bolts.

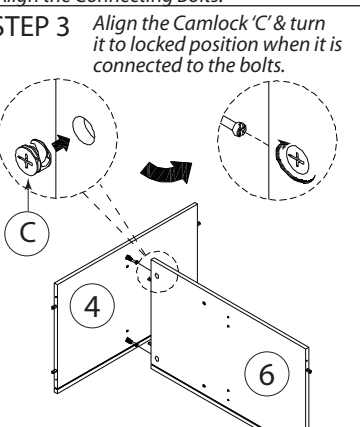

STEP 4

