

# ASSEMBLY INSTRUCTIONS

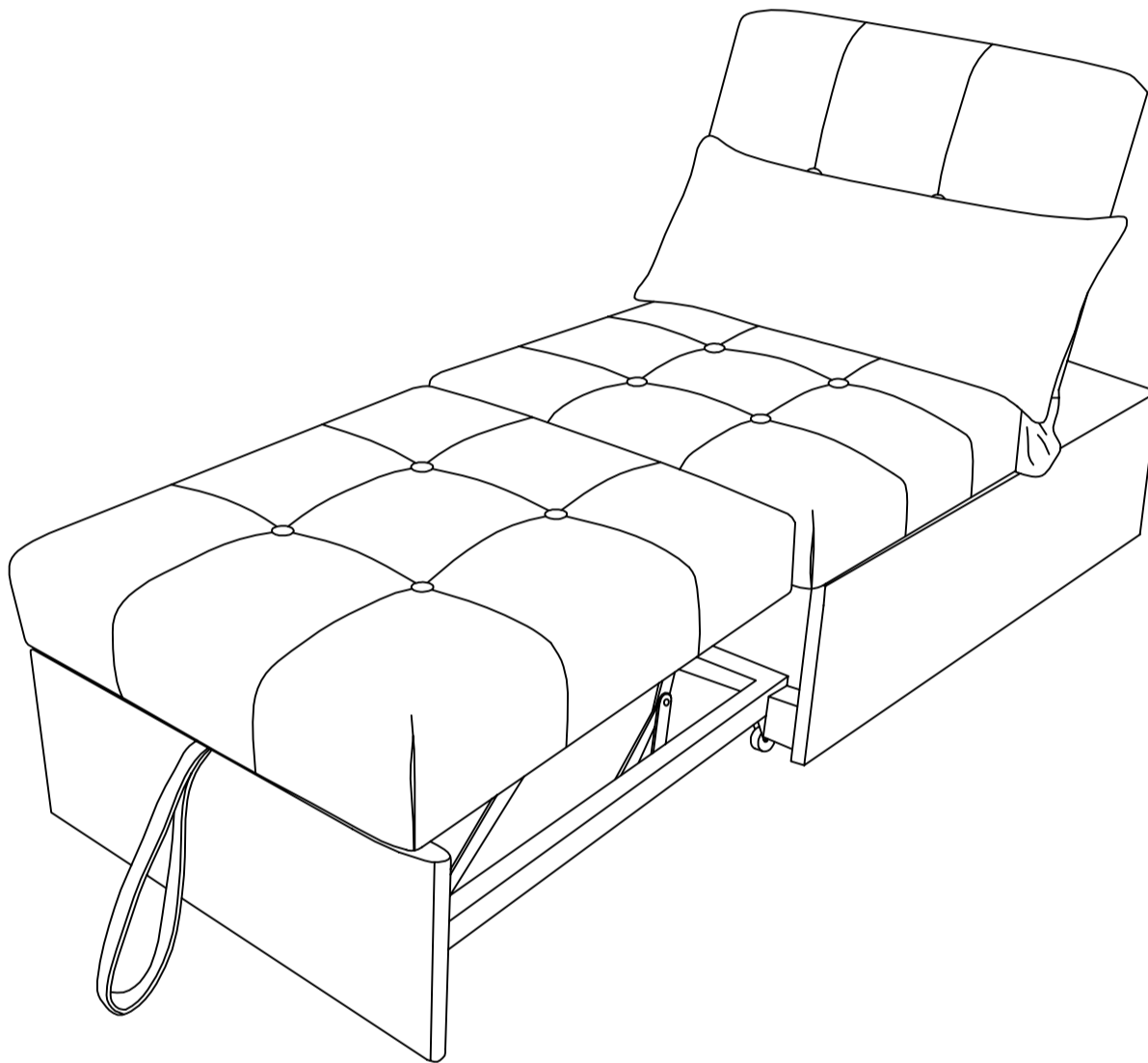

## FB77-WH/LG/DG Convertible Chair



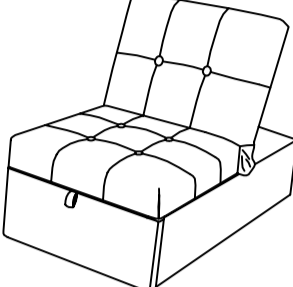

### NOTE TO CUSTOMERS:

- For ease and speed of assembly we recommend that before you commence each step of the assembly that you identify all the parts required to complete that step.
- We recommend that where possible you allow sufficient space to assemble the item as close as possible to the place where it will be once assembled.
- For the protection of your furniture we recommend that the product is placed on protected surfaces during assembly to prevent any damage.
- During assembly do not over tighten, as this may damage the product.
- Please ensure you retain all the product packaging until the item completely assembled.
- Please periodically check all fittings and re-tighten as necessary.
- It is recommended that this item should be assembled by two adults.

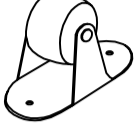
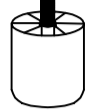
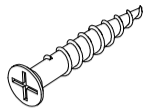
# Part List

<b>A</b> Quantity of 1  Seat	<b>B</b> Quantity of 1  Pillow	<b>C</b> Quantity of 4  Caster	<b>D</b> Quantity of 4  Leg	<b>E</b> Quantity of 8  Screw
--	--	--	---	---

## Step 1

C:		4pcs
D:		4pcs
E:		8pcs

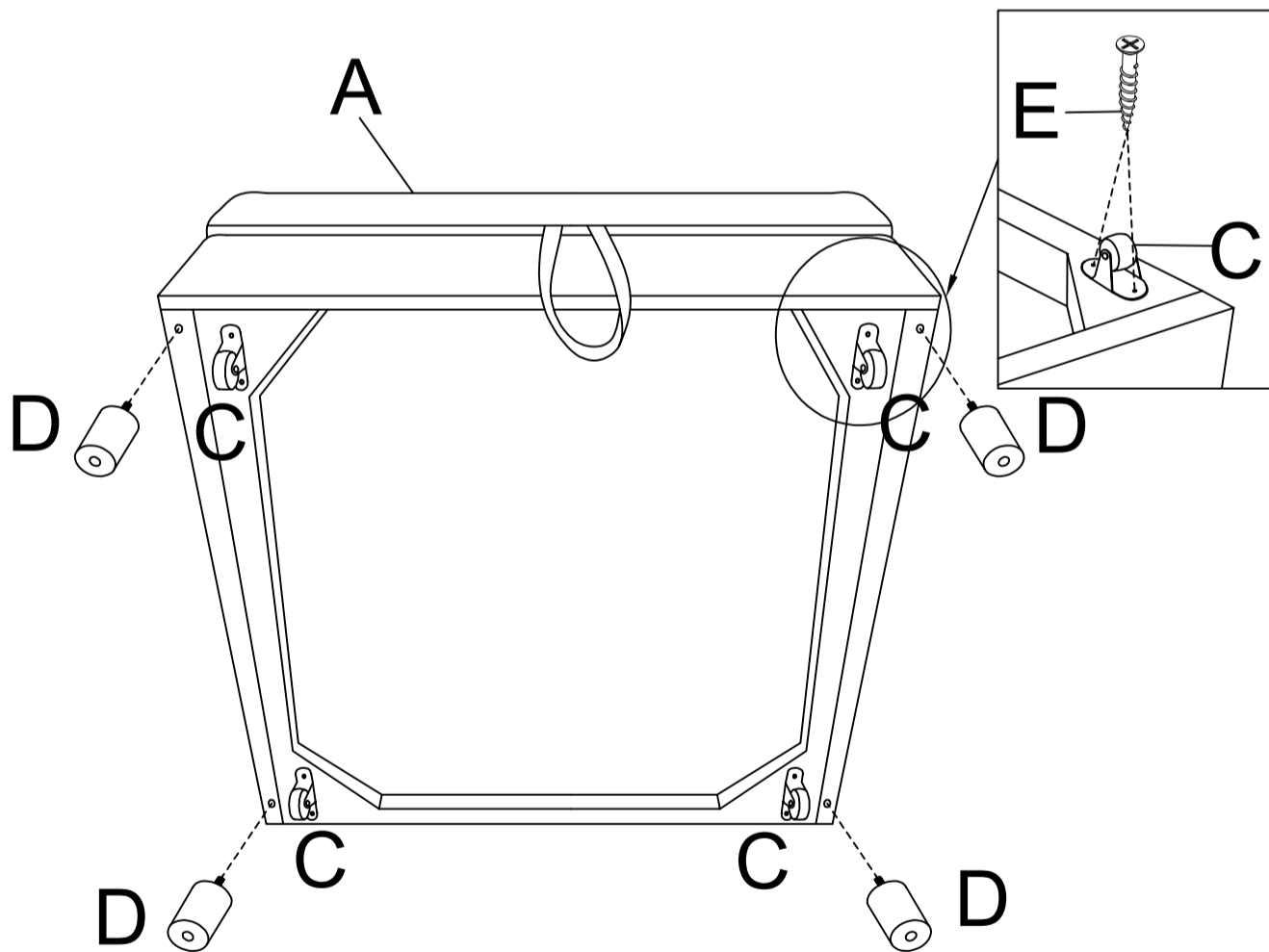

Insert and Tighten legs (D) into the seat (A) as shown above.  
 Assemble casters (C) to the seat (A) using screws (E) as shown above.

## Step 2

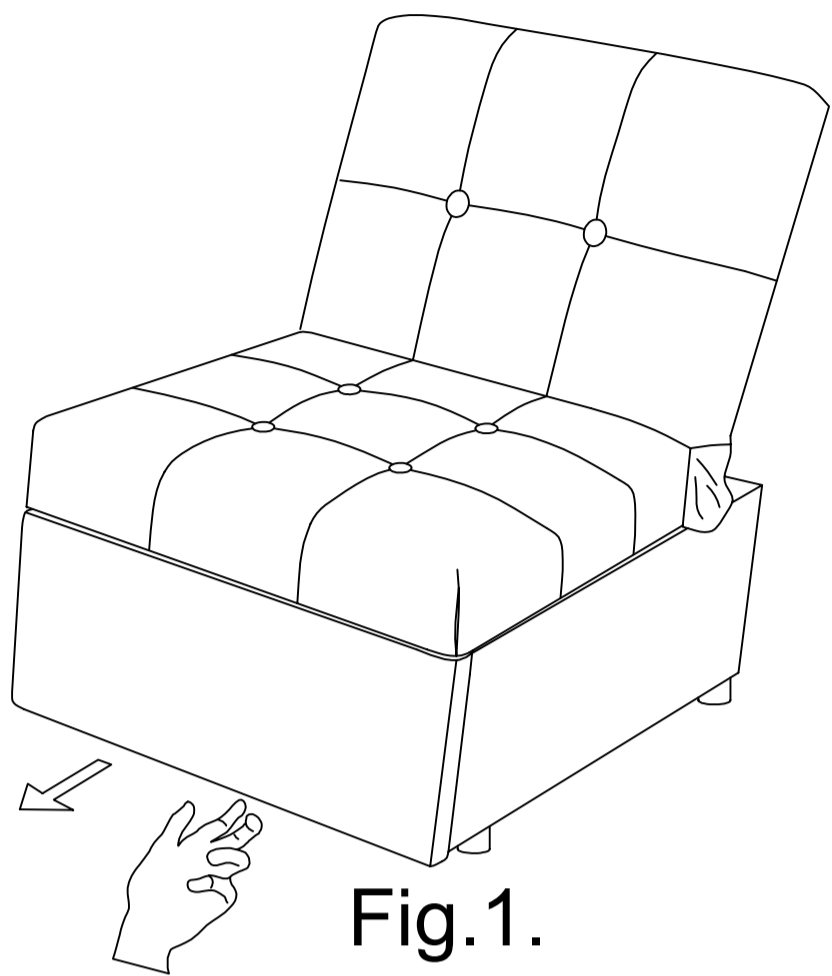

**Fig.1.**

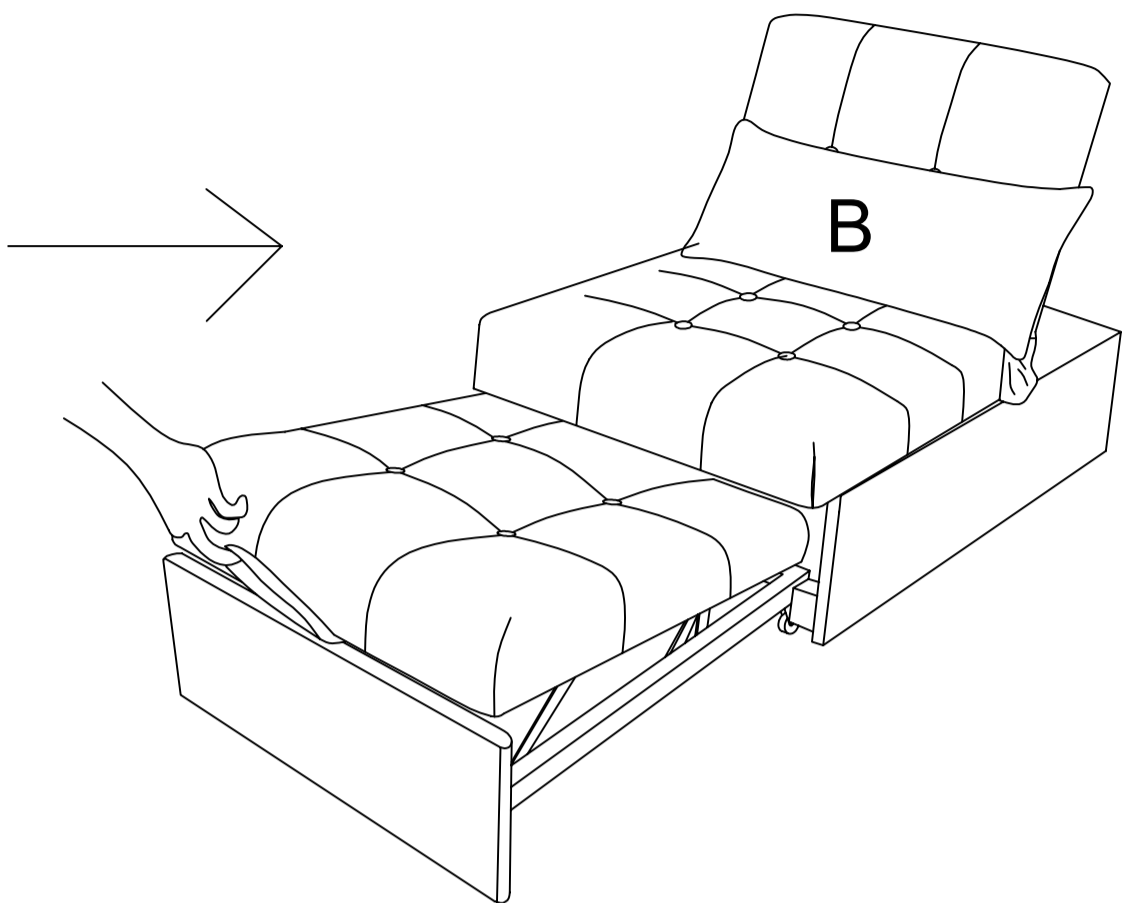

**Fig.2.**

Pull out seat frame ,refer to fig.1. then lift the seat cushion ,refer to Fig.2.

## Step 3

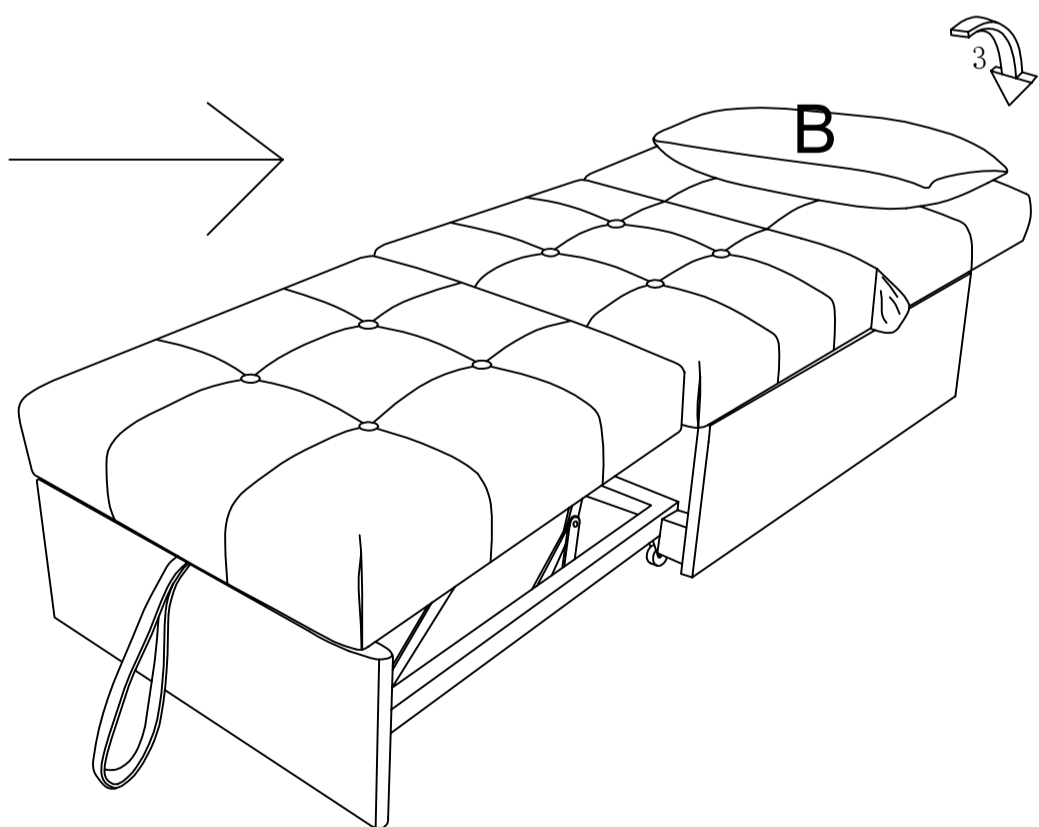
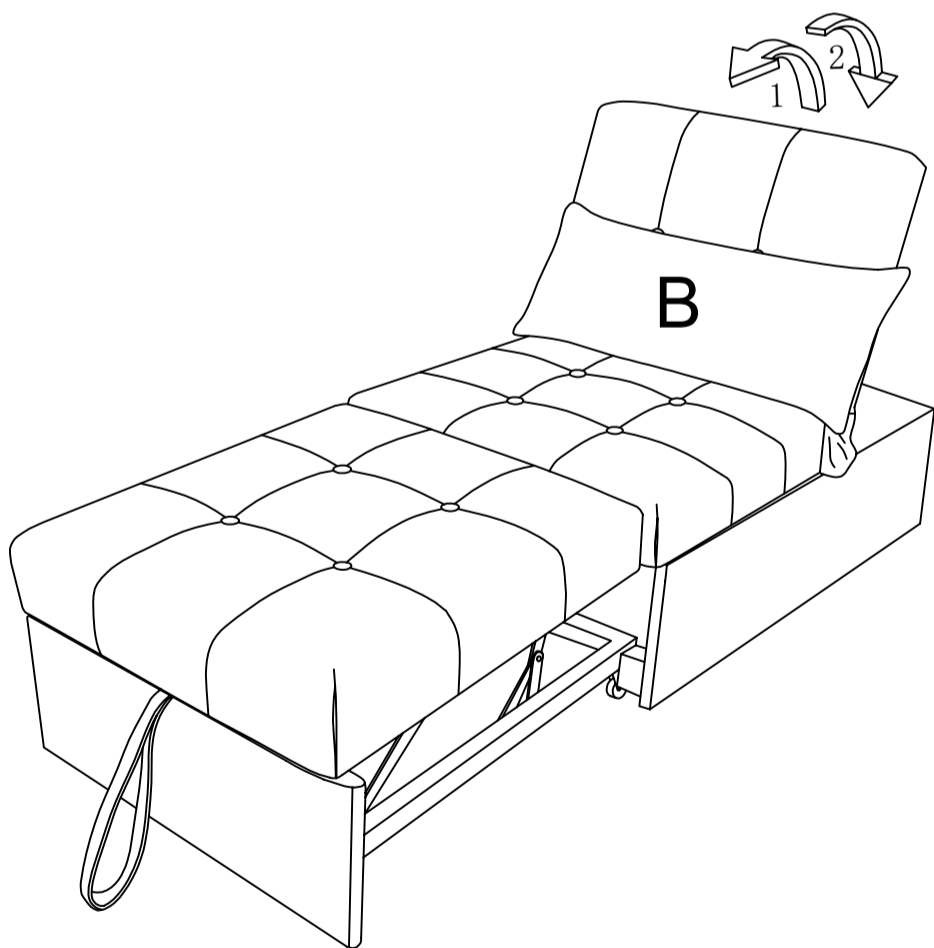

The backrest is adjustable to three positions, refer to diagram above.