

ASSEMBLY INSTRUCTIONS

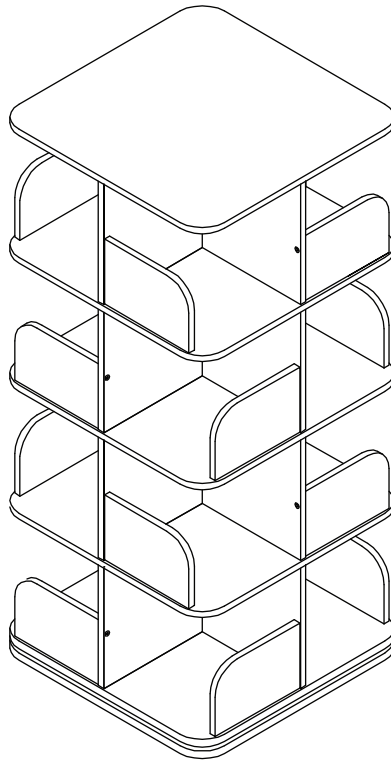





MODEL : #BK006- REVOLVING TALL BOOKCASE



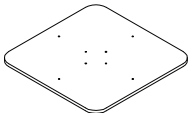
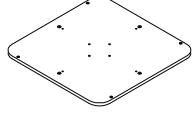
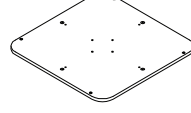
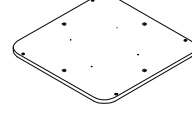
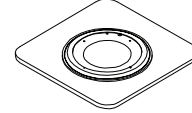
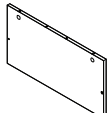
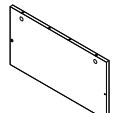

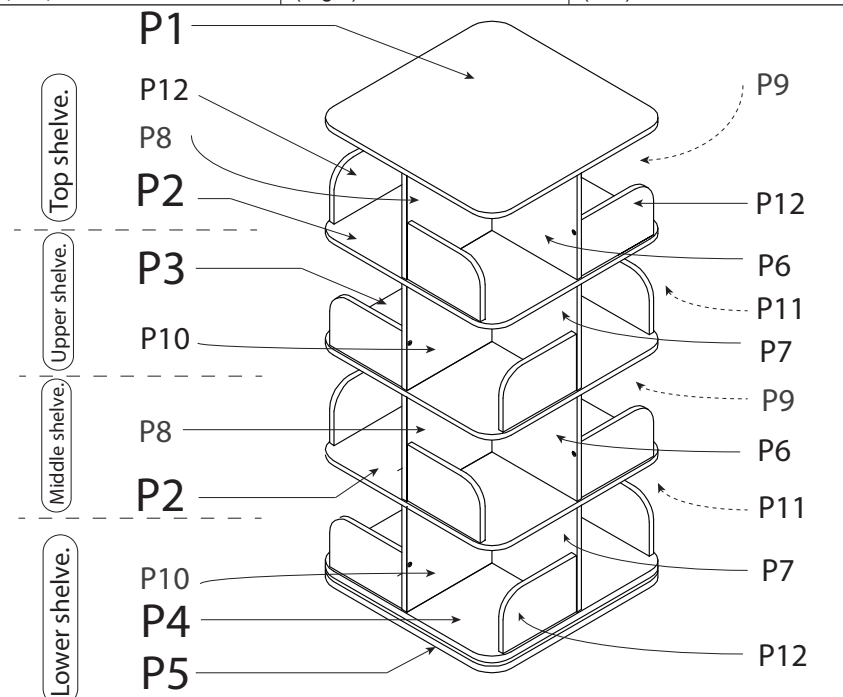

NOTE TO CUSTOMERS:

- For ease and speed of assembly we recommend that before you commence each step of the assembly that you identify all the parts required to complete that step.
- We recommend that where possible you allow sufficient space to assemble the item as close as possible to the place where it will be once assembled.
- For the protection of your furniture we recommend that the product is placed on a dry, soft, smooth and clean surfaces during assembly to prevent any damage. Avoid damp and direct sunlight.
- During assembly do not over tighten the screws or bolts, as this may damage the product.
- Please ensure you retain all the product packaging until the item is completely assembled.
- Periodically check all fitting and re-tighten as necessary.
- Never allow any liquids to remain on your furniture as absorption can cause the wood to warp or finish to de-laminate.
- It is recommended that this item should be assembled by two adults.

PARTS IDENTIFICATION

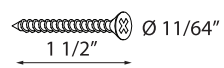
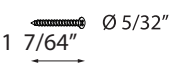
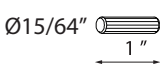
<p>P1 Quantity: 1</p>  <p>Top Panel</p>	<p>P2 Quantity: 2</p>  <p>Top/Lower Shelf Panel</p>	<p>P3 Quantity: 1</p>  <p>Middle Shelf Panel</p>	<p>P4 Quantity: 1</p>  <p>Lower (Revolving) Shelf Panel</p>	<p>P5 Quantity: 1</p>  <p>Base Panel (come with a revolving mechanism)</p>
<p>P6 Quantity: 2</p>  <p>Top/Middle Partition</p>	<p>P7 Quantity: 2</p>  <p>Top/Middle Partition</p>	<p>P8 Quantity: 2</p>  <p>Top/Middle Divider Panel (Left)</p>	<p>P9 Quantity: 2</p>  <p>Top/Middle Divider Panel (Right)</p>	<p>P10 Quantity: 2</p>  <p>Upper/Lower Divider Panel (Left)</p>
<p>P11 Quantity: 2</p>  <p>Upper/Lower Divider Panel (Right)</p>	<p>P12 Quantity: 16</p>  <p>Stopper Panels</p>			

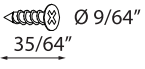
HARDWARE LIST

<p>H1 Screw #9 x 1 1/2"</p>  <p>Quantity: 48 pcs</p>	<p>H2 Screw m4 x 28mm</p>  <p>Quantity: 5 pcs</p>
<p>H3 Wooden Dowel M6 x 25</p>  <p>Quantity: 48 pcs</p>	<p>H4 Connecting Bolt</p>  <p>Quantity: 16 pcs</p>
<p>H5 Cam Lock 15/9.5mm</p>  <p>Quantity: 16 pcs</p>	<p>H6 Screw m3.5 x 14mm</p>  <p>Quantity: 4 pcs</p>
<p>H7 Leg Stud</p>  <p>Quantity: 5 pcs</p>	<p>H8 Sticker</p>  <p>Quantity: 32 pcs</p>

TOOLS REQUIRED

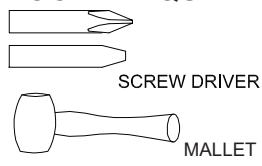

STEP 3 2 sets of these assembly, one for Top Shelf and one for Middle Shelf.

STEP 1

Insert wooden dowels H3

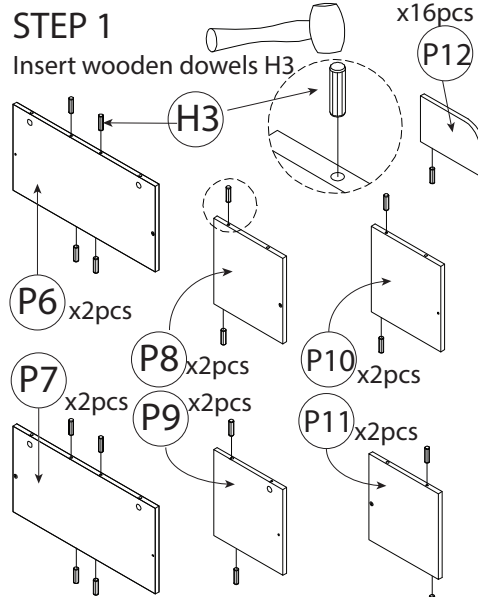

x16pcs P12

H3

P6 x2pcs

P7 x2pcs

P8 x2pcs

P9 x2pcs

P10 x2pcs

P11 x2pcs

STEP 2

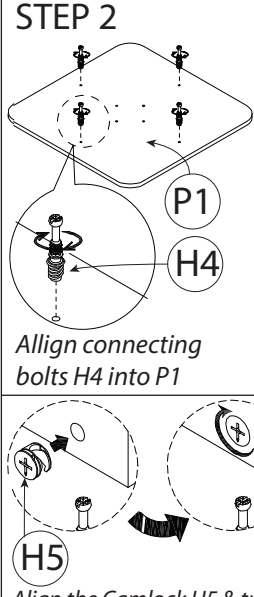

Align connecting bolts H4 into P1

H4

H5

Align the Camlock H5 & turn it to locked position when it is connected to the bolts.

STEP 3

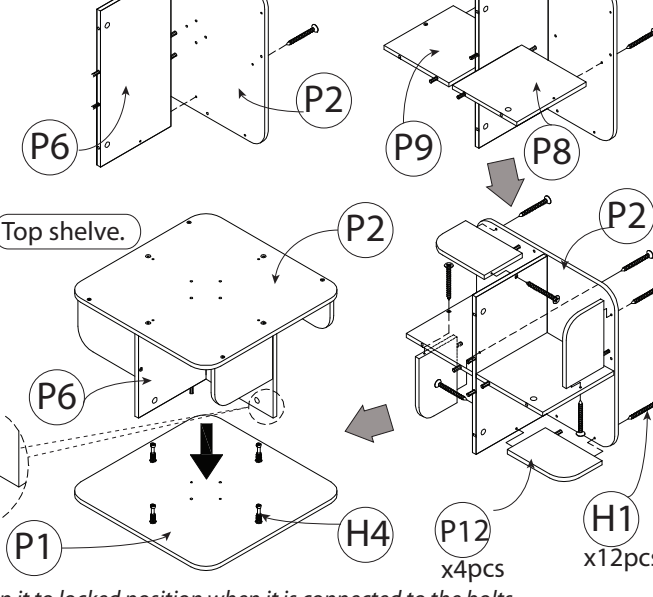

Top shelf.

P6

P2

P9

P8

P2

P2

P12 x4pcs

H1 x12pcs

ASSEMBLY INSTRUCTIONS

ITEM: #BK006 - REVOLVING TALL BOOKCASE

STEP 4 Continue with the assembly of the Upper Shelf.

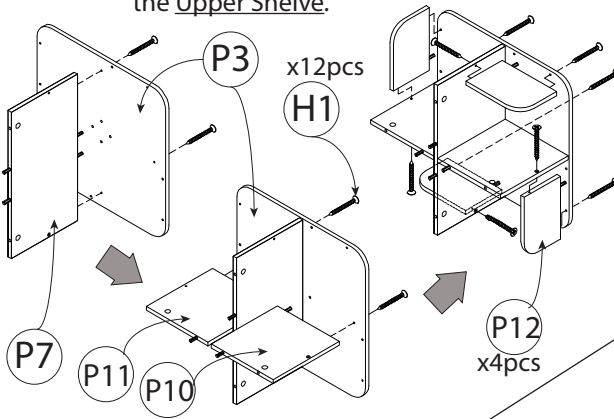

STEP 5 Assemble the Lower shelf.

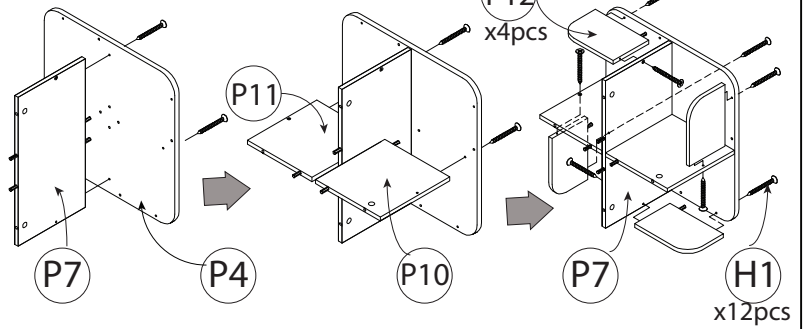

STEP 6 Align the Connecting Bolts H4 into the underside of P2 (Top Shelf).

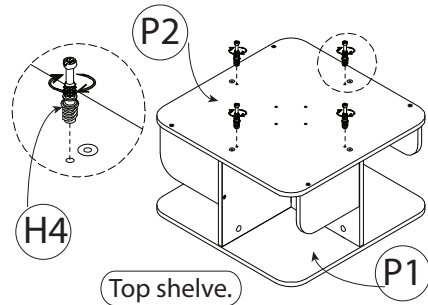

STEP 7 Connect the Upper Shelf into the Top shelf.

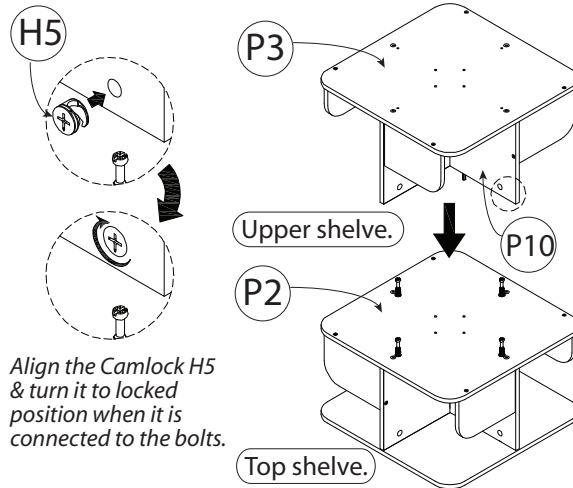

STEP 8

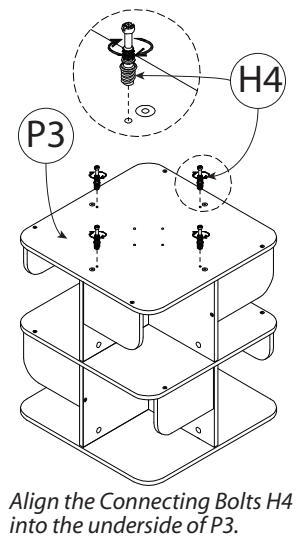

STEP 9 Connect the Middle Shelf into the Upper shelf.

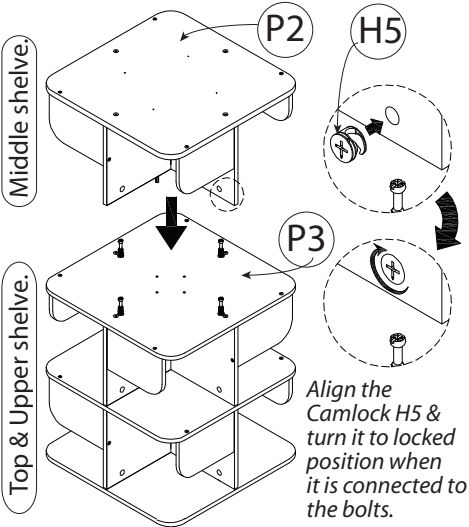

STEP 10 Align the Connecting Bolts H4 into the underside of P2 of Middle Shelf.

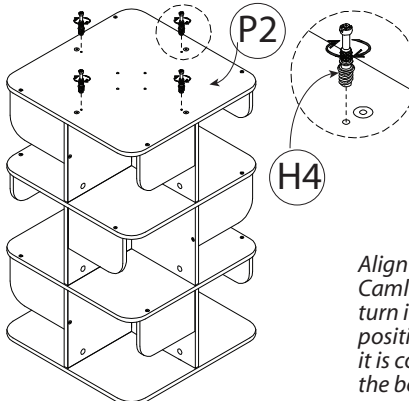

STEP 11 Connect the Lower Shelf into the Middle shelf.

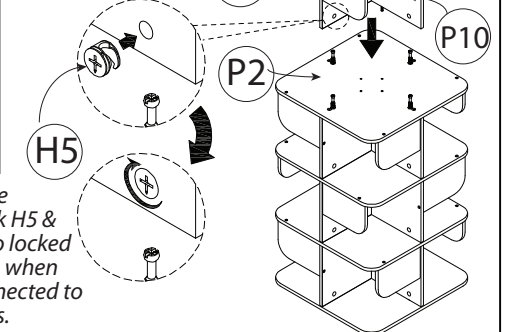

STEP 12 Assemble the base panel P5 into the underside of the Lower Shelf (P4)

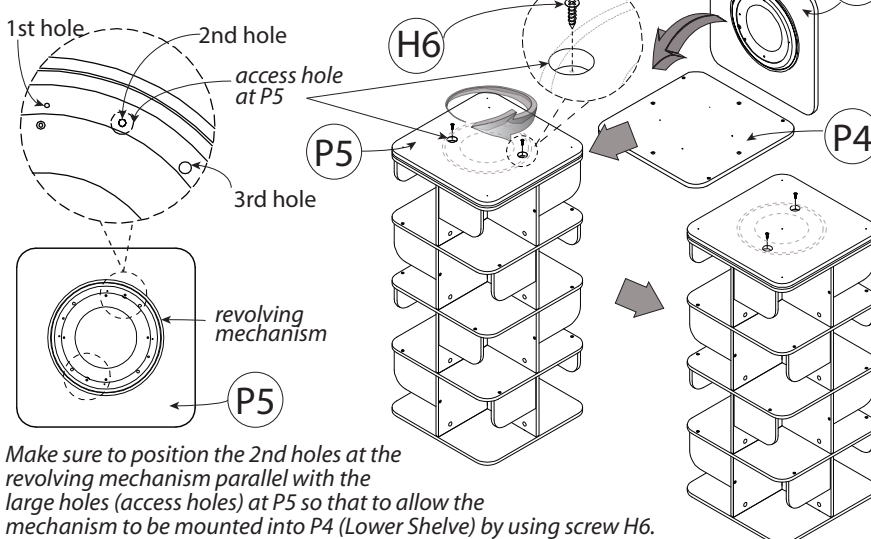

STEP 13 Assemble the Leg Studs H7 to the base panel P5.

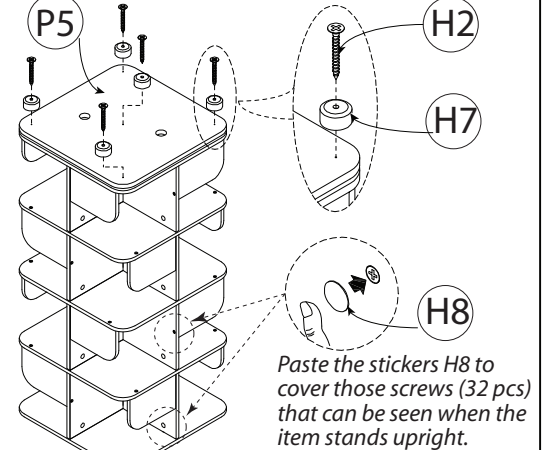

PUT THE ITEM UPRIGHT, AND IT IS READY TO USE. CONGRATULATIONS!