

# ASSEMBLY INSTRUCTIONS

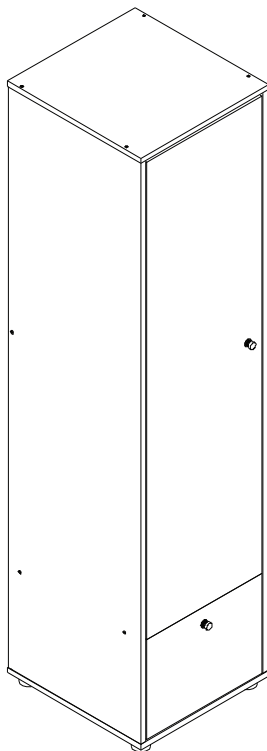





## MODEL #GR8976 - GARMENT RACK



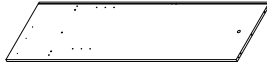
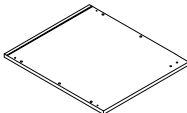
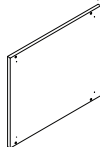
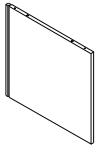

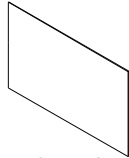

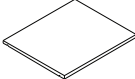
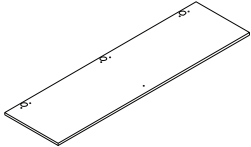
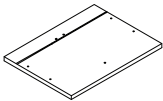
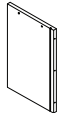

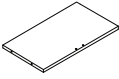
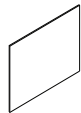



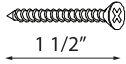

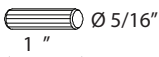
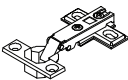
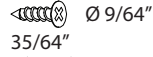
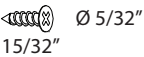
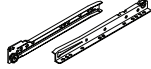
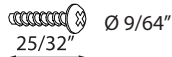

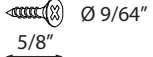
### NOTE TO CUSTOMERS:

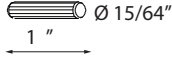
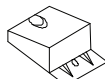
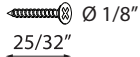
- For ease and speed of assembly we recommend that before you commence each step of the assembly that you identify all the parts required to complete that step.
- We recommend that where possible you allow sufficient space to assemble the item as close as possible to the place where it will be once assembled.
- For the protection of your furniture we recommend that the product is placed on a dry, soft, smooth and clean surfaces during assembly to prevent any damage. Avoid damp and direct sunlight.
- During assembly do not over tighten the screws or bolts, as this may damage the product.
- Please ensure you retain all the product packaging until the item is completely assembled.
- Periodically check all fitting and re-tighten as necessary.
- Never allow any liquids to remain on your furniture as absorption can cause the wood to warp or finish to de-laminate.
- It is recommended that this item should be assembled by two adults.

## PARTS IDENTIFICATION

<p>P1 Quantity: 1</p>  <p>Side Panel-Left</p>	<p>P2 Quantity: 1</p>  <p>Side Panel-Right</p>	<p>P3 Quantity: 1</p>  <p>Top Panel</p>	<p>P4 Quantity: 1</p>  <p>Base Panel</p>	<p>P5 Quantity: 1</p>  <p>Middle Shelf</p>
<p>P6 Quantity: 1</p>  <p>Back Panel Holder</p>	<p>P7 Quantity: 2</p>  <p>Upper Back Panel</p>	<p>P8 Quantity: 1</p>  <p>Lower Back Panel</p>	<p>P9 Quantity: 1</p>  <p>Removable Shelf</p>	<p>P10 Quantity: 1</p>  <p>Door</p>
<p>P11 Quantity: 1</p>  <p>Drawer Front</p>	<p>P12 Quantity: 1</p>  <p>Drawer Side-Left</p>	<p>P13 Quantity: 1</p>  <p>Drawer Side-Right</p>	<p>P14 Quantity: 1</p>  <p>Drawer Back</p>	<p>P15 Quantity: 1</p>  <p>Drawer Base</p>

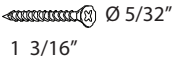
## HARDWARE LIST

<p>P16 Quantity: 1</p>  <p>Drawer Base Support</p>				
<p>H1 Screw #9 x 1 1/2"</p>  <p>Quantity: 20 pcs</p>	<p>H2 Connecting Bolts</p>  <p>Quantity: 5 pcs</p>	<p>H3 Cam Lock 12/9.5mm</p>  <p>Quantity: 5 pcs</p>	<p>H4 Wood Dowel M8 x 25</p>  <p>Quantity: 20 pcs</p>	
<p>H5 Hinges</p>  <p>Quantity: 3 sets</p>	<p>H6 Screw for Hinges m3.5 x 14</p>  <p>Quantity: 12 pcs</p>	<p>H7 Screw for slides m4 x 12</p>  <p>Quantity: 12 pcs</p>	<p>H8 Drawer slides</p>  <p>Quantity: 1 set</p>	<p>H9 Screw for knobs #6x22</p>  <p>Quantity: 2 pcs</p>
<p>H10 Knob</p>  <p>Quantity: 2 pcs</p>	<p>H11 Screw for Door Stopper &amp; Strap m3.5 x 16</p>  <p>Quantity: 2 pcs</p>	<p>H12 Door stopper</p>  <p>Quantity: 1 pc</p>	<p>H13 Wood Dowel M6 x 25</p>  <p>Quantity: 1 pc</p>	<p>H14 Corner Wedges</p>  <p>Quantity: 6 pcs</p>
<p>H15 Screw for Wedges m3 x 20</p>  <p>Quantity: 6 pcs</p>	<p>H16 Shelf Support Pin</p>  <p>Quantity: 4 pcs</p>	<p>H17 Metal Hanger's rod</p>  <p>Quantity: 1 pc</p>	<p>H18 Stickers</p>  <p>Quantity: 6 pcs</p>	<p>H19 Anti-Tip Strap</p>  <p>Quantity: 1 pc</p>
<p>H20 Wall Plug for H20</p>  <p>Quantity: 1 pc</p>	<p>H21 Screw #6 x 1 1/4" for Anti-Tip strap to wall</p>  <p>Quantity: 1 pc</p>	<p>H22 Screw for Legs m4 x 30</p>  <p>Quantity: 4 pcs</p>	<p>H23 PVC Legs</p>  <p>Quantity: 4 pcs</p>	<p><b>TOOLS REQUIRED</b></p>  <p>Household screw driver Rubber Mallet</p>

### STEP 1

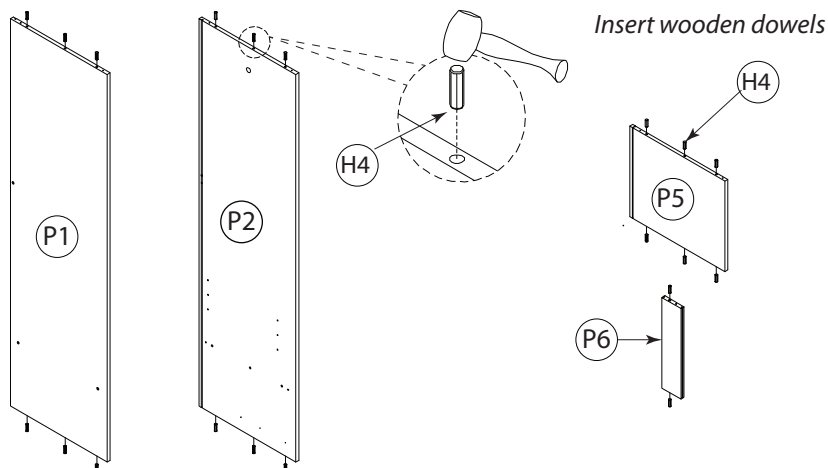

## STEP 2 Install Drawer Slides

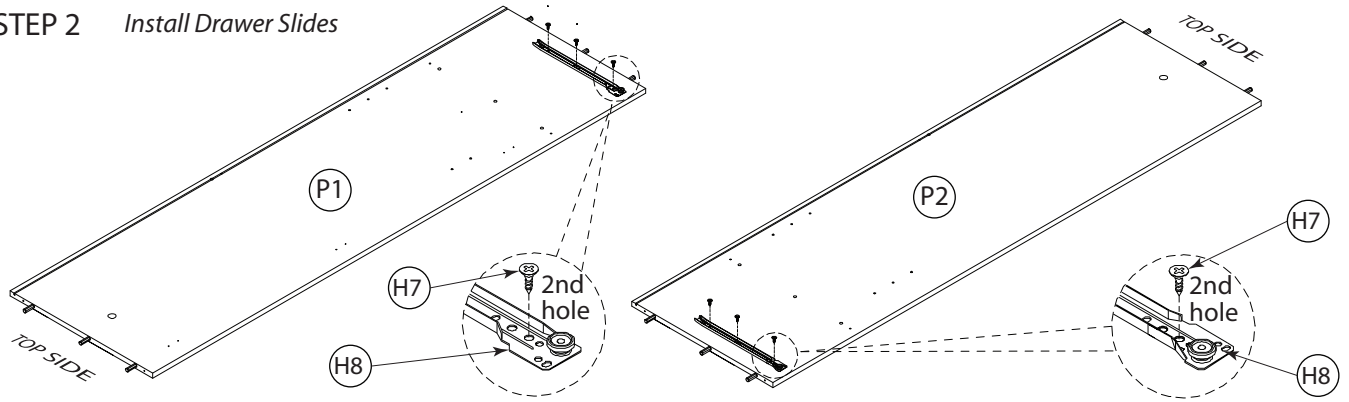

## STEP 3

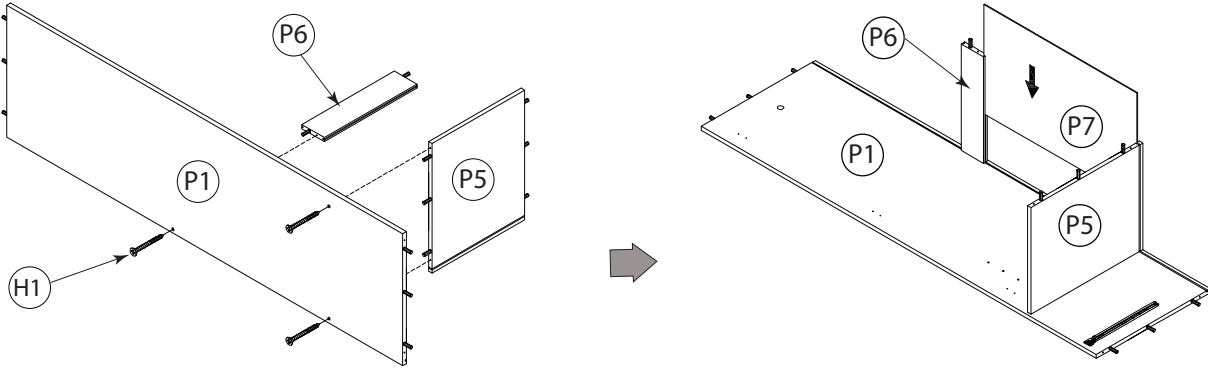

## STEP 4

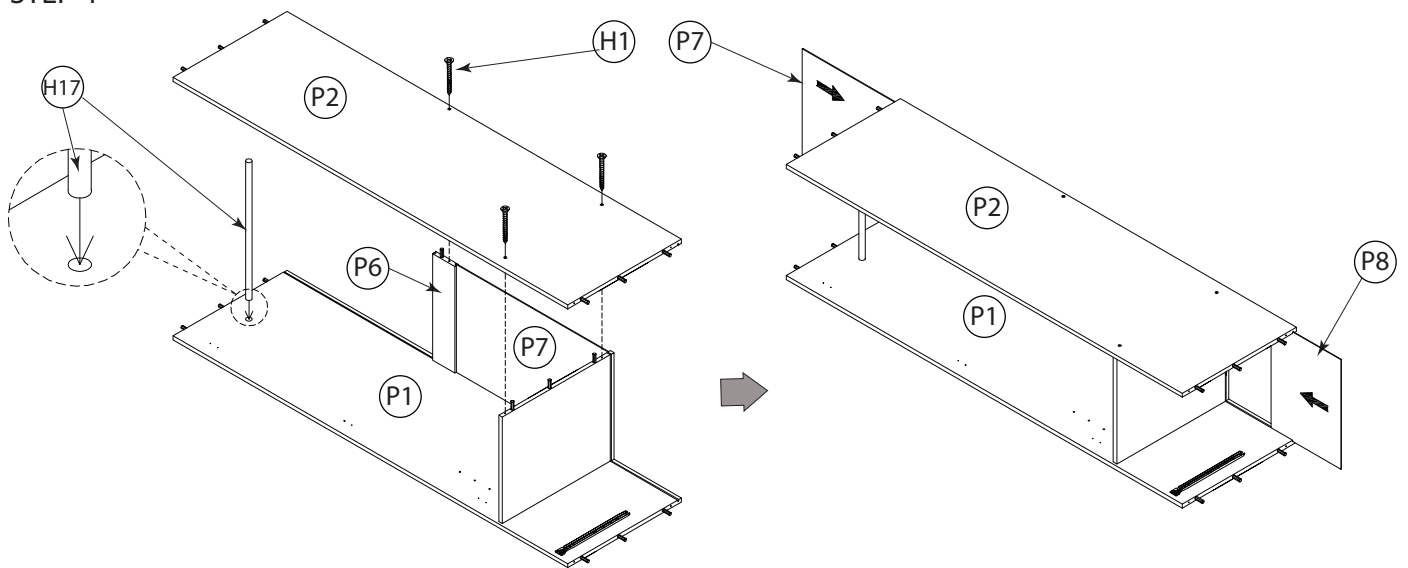

## STEP 5

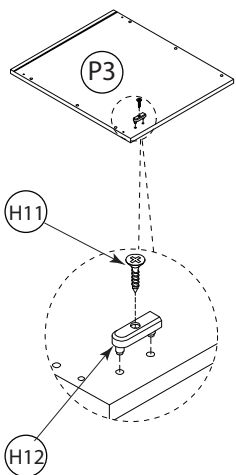

## STEP 6

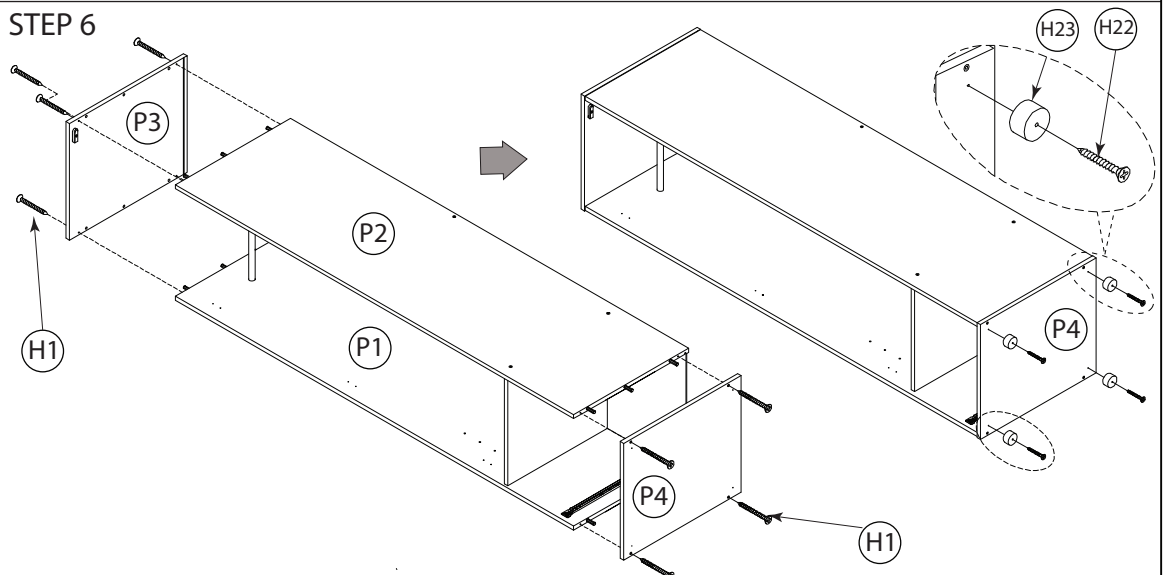

## STEP 7 Assemble the drawer.

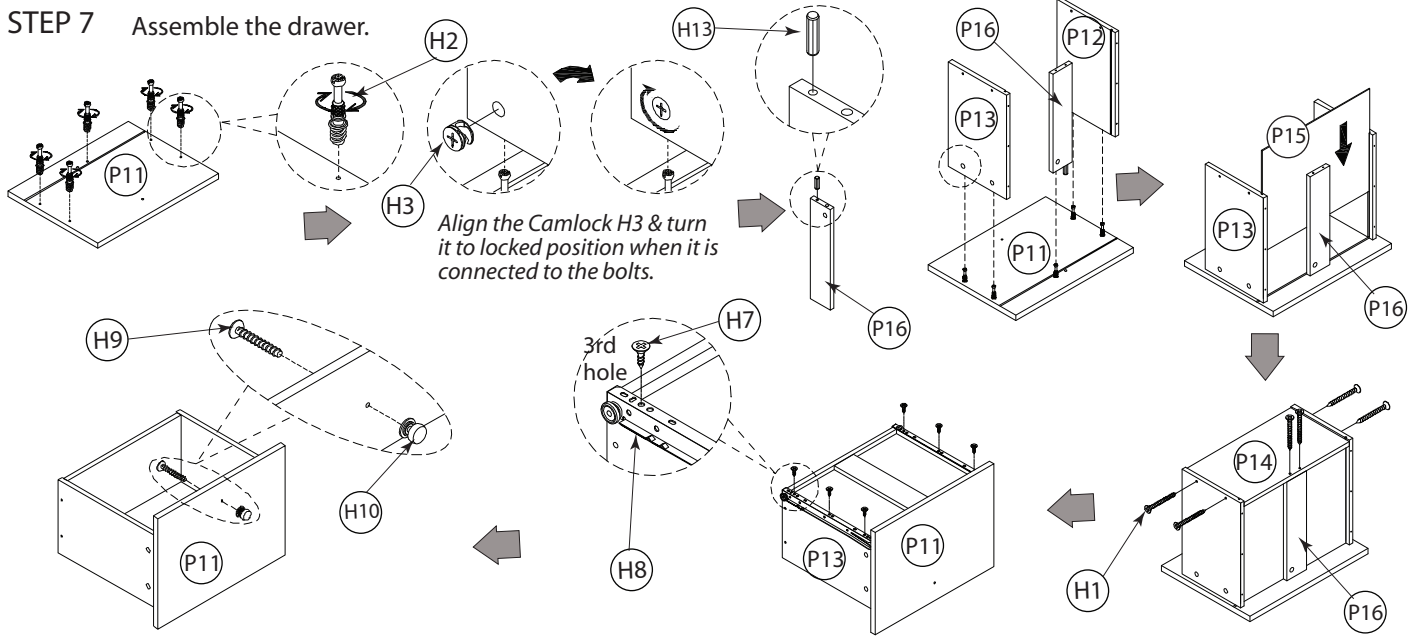

## STEP 8

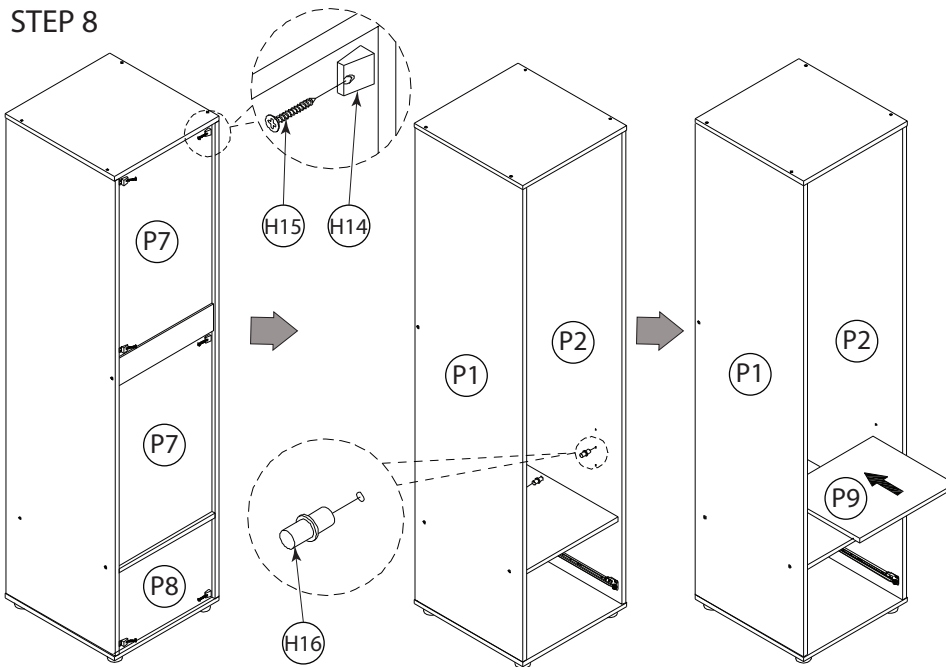

## STEP 9

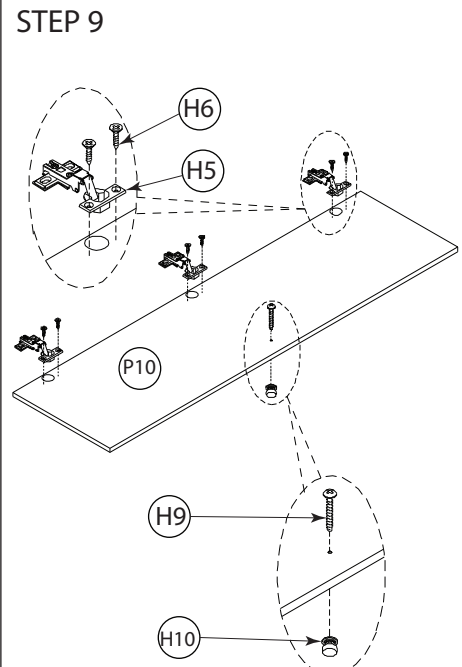

## STEP 10

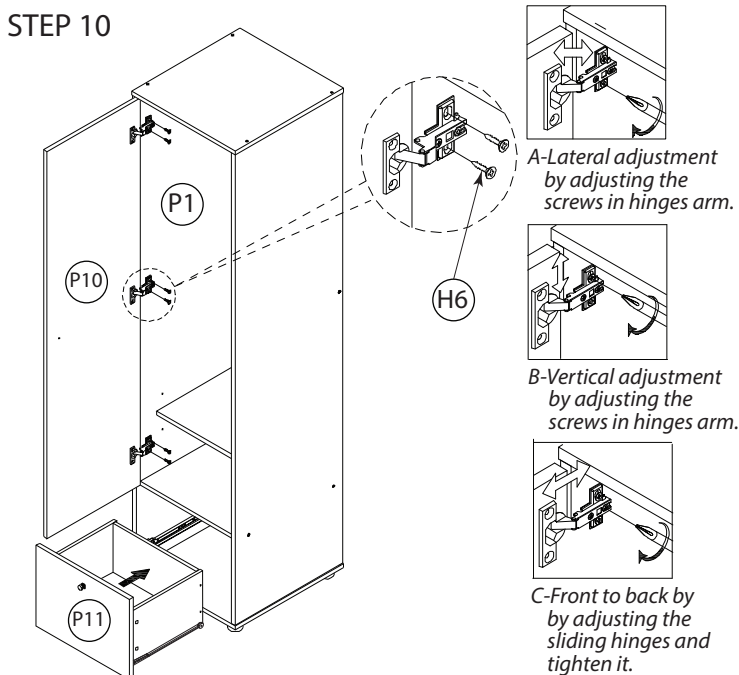

## STEP 11

