

ASSEMBLY INSTRUCTIONS

MODEL #D6691-1 DINING TABLE

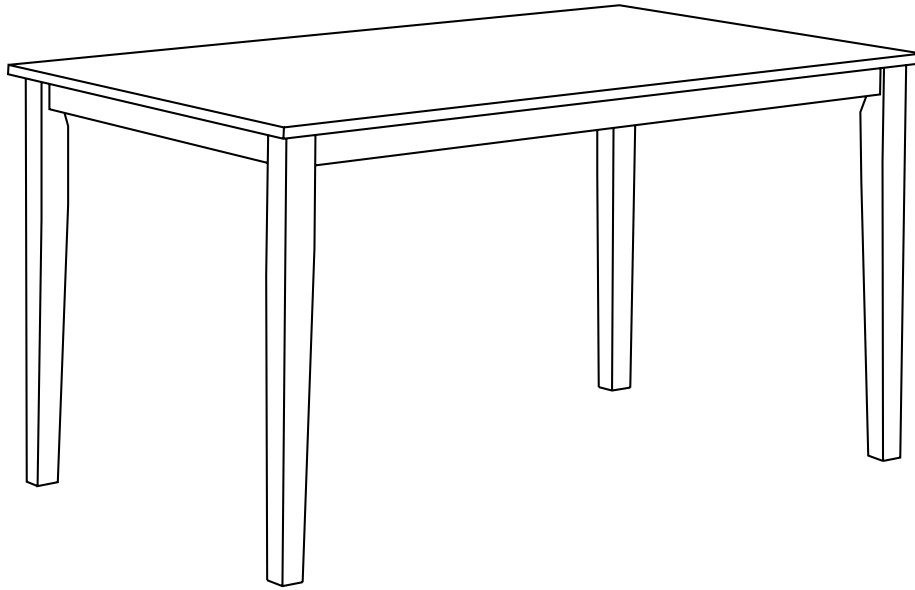

NOTE TO CUSTOMERS:

- For ease and speed of assembly we recommend that before you commence each step of the assembly that you identify all the parts required to complete that step.
- We recommend that where possible you allow sufficient space to assemble the item as close as possible to the place where it will be once assembled.
- For the protection of your furniture we recommend that the product is placed on protected surfaces during assembly to prevent any damage.
- During assembly do not over tighten the screws or bolts, as this may damage the product.
- Please ensure you retain all the product packaging until the item is completely assembled.
- Periodically check all fitting and re-tighten as necessary.
- Never allow any liquids to remain on your furniture as absorption can cause the wood to warp or finish to de-laminate.
- It is recommended that this item should be assembled by two adults.

PARTS IDENTIFICATION

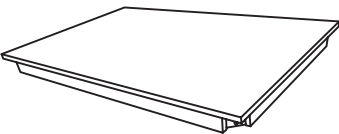
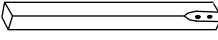
1-	Table Top		1 pc
2-	Table Legs		4 pcs

HARDWARE IDENTIFICATION

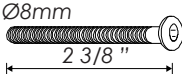
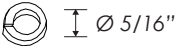
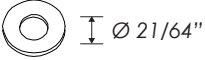
A-	Allen Key M5		1 pc
B-	JCBB Bolt M8 x 60mm		8 pcs
C-	Spring Washer 5/16" x 15mm		8 pcs
D-	Flat Washer 21/64" x 18mm		8 pcs

NOTE: Quantities shown are for one table.
Bolts are metric screw threads

