

ASSEMBLY INSTRUCTIONS

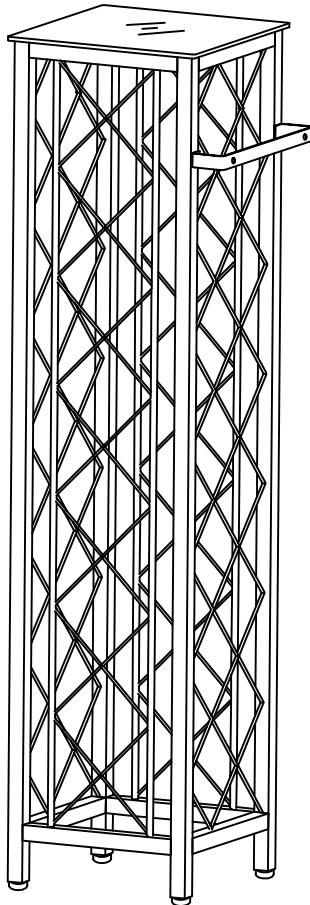



Style # WR1423 Wine Rack



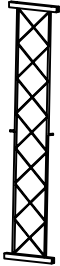
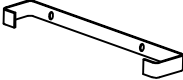

NOTE TO CUSTOMERS:

- For ease and speed of assembly we recommend that before you commence each step of the assembly that you identify all the parts required to complete that step.
- We recommend that where possible you allow sufficient space to assemble the item as close as possible to the place where it will be once assembled.
- For the protection of your furniture we recommend that the product is placed on protected surfaces during assembly to prevent any damage.
- During assembly do not over tighten, as this may damage the product.
- Please ensure you retain all the product packaging until the item completely assembled.
- Please periodically check all fittings and re-tighten as necessary.
- Never allow any liquids to remain on your furniture as absorption can cause the wood to warp or the finish to de-laminate.
- It is recommended that this item should be assembled by two adults.

Part List

A1.	Quantity of 1	A2.	Quantity of 1	A3.	Quantity of 2	A4.	Quantity of 1	A5.	Quantity of 1
									
Front Frame		Back Frame		Side Frame		Connect Bar		Glass	

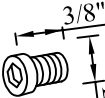
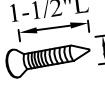
Hardware List

B1.	Quantity of 8	B2.	Quantity of 2	B3.	Quantity of 2	B4.	Quantity of 2	B5.	Quantity of 4
									
Bolt		Bolt		Screw		Anchor		Suction Cup	

STEP 1

B1  8pcs

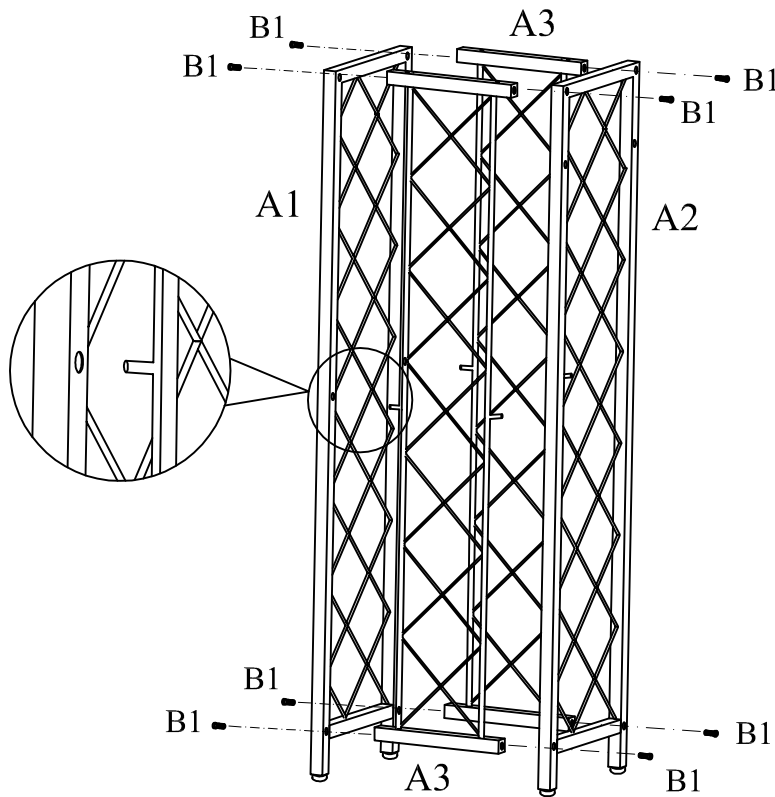

Assemble Frames A1&A2 to Side Frames A3 using Bolts B1.

STEP 2

B2  2pcs

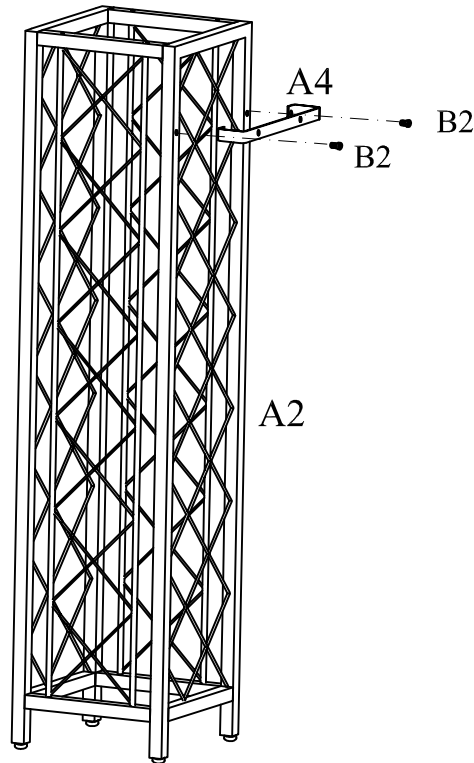

Assemble Connect Bar A4 to Back Frame A2 using Bolts B2.

STEP 3

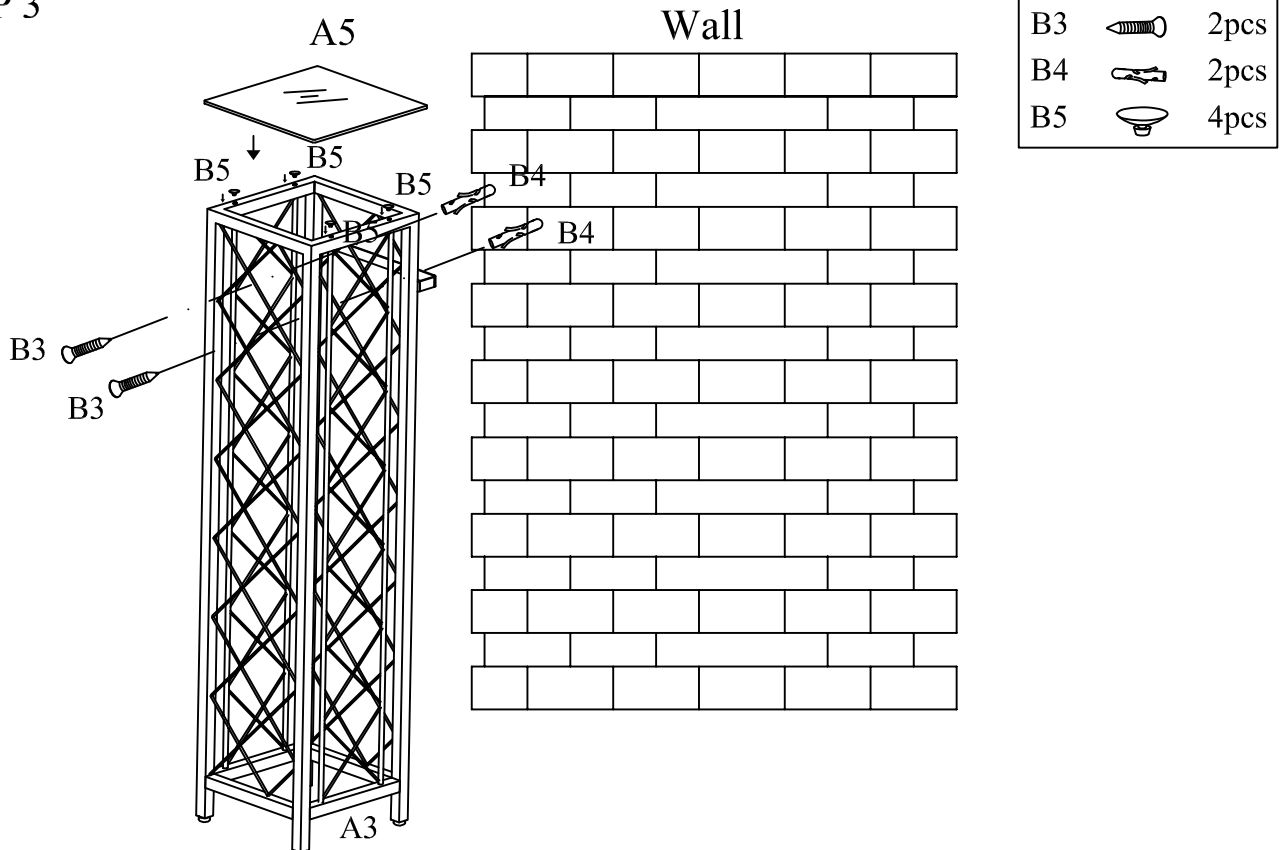

- 1).For your safety,please attach this unit to the wall by Screws B3 and Anchors B4.
- 2).Insert Suction Cups B5 to Side Frames A3,then put Glass A5 onto Suction Cups B5 as shown above.