

ASSEMBLY INSTRUCTIONS

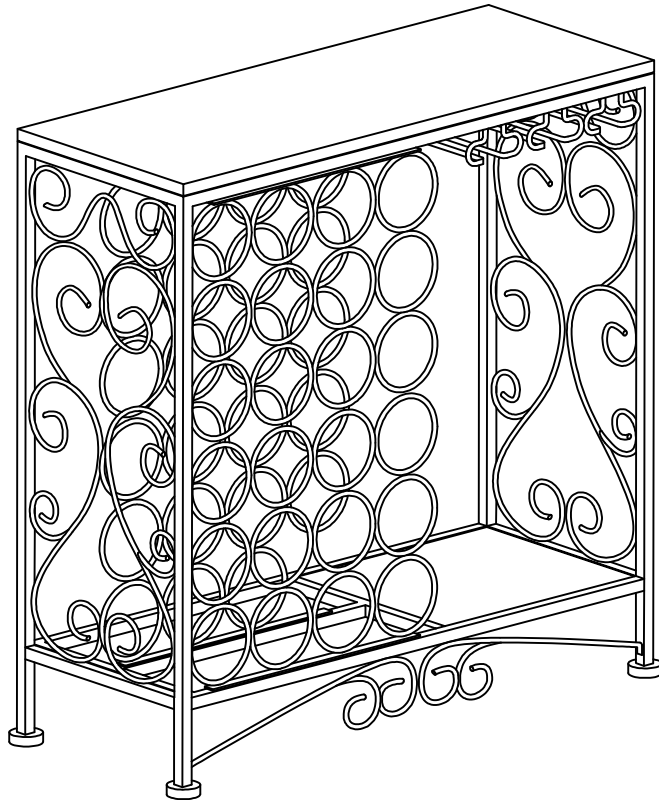





Style # WR1349 Wire Rack





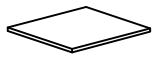

NOTE TO CUSTOMERS:

- For ease and speed of assembly we recommend that before you commence each step of the assembly that you identify all the parts required to complete that step.
- We recommend that where possible you allow sufficient space to assemble the item as close as possible to the place where it will be once assembled.
- For the protection of your furniture we recommend that the product is placed on protected surfaces during assembly to prevent any damage.
- During assembly do not over tighten, as this may damage the product.
- Please ensure you retain all the product packaging until the item completely assembled.
- Please periodically check all fittings and re-tighten as necessary.
- Please never allow any liquids to remain on your furniture as absorption can cause the wood to warp or finish to de-laminate.
- It is recommended that this item should be assembled by two adults.

Part List

 A: Side Frame 1PC	Left  B: Side Frame 1PC	Right  C: Bottom Frame 1PC	 D: Top Frame 1PC
 E: Wine Holder 2PCS	 F: Connect Bar 1PC	 G: Top Panel 1PC	 H: Bottom Panel 1PC

Hardware List

 a: Bolt 8PCS	 b: Bolt 10PCS	 c: Short Screw 4PCS	 d: Long Screw 4PCS	 e: Allen Key 1PC
---	--	--	---	---

STEP 1

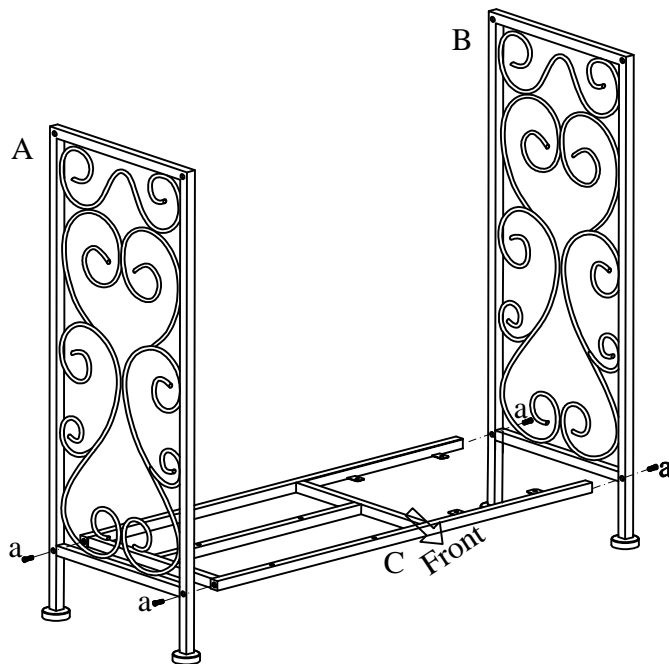

Assemble Bottom Frame (C) to Side Frames (A&B) using Bolts (a). Please do not tighten Bolts (a) until step 5.

STEP 2

a  4pcs

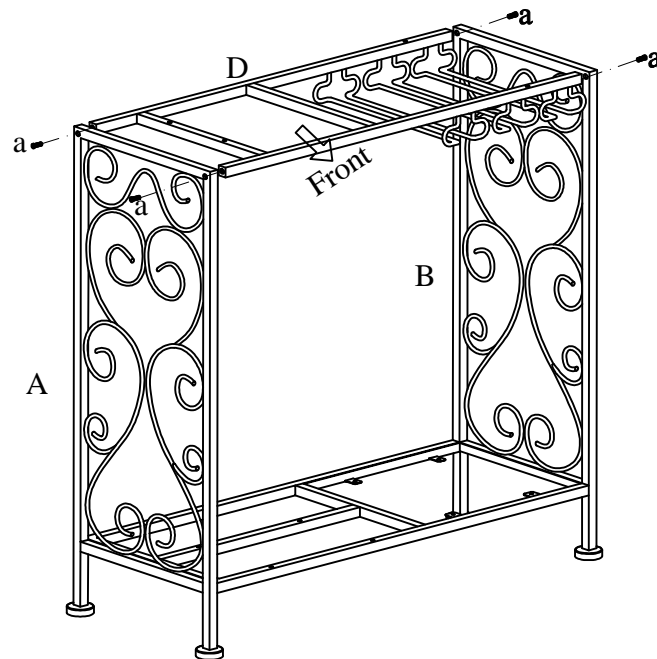

Assemble Top Frame (D) to Side Frames (A&B) using Bolts (a). Please do not tighten Bolts (a) until step 5.

STEP 3

d  4pcs

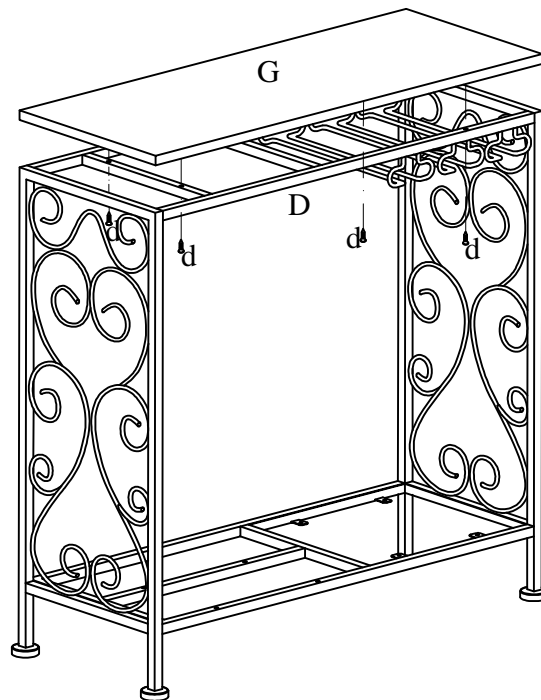

Assemble Top Panel (G) to Top Frame (D) using Screws (d).

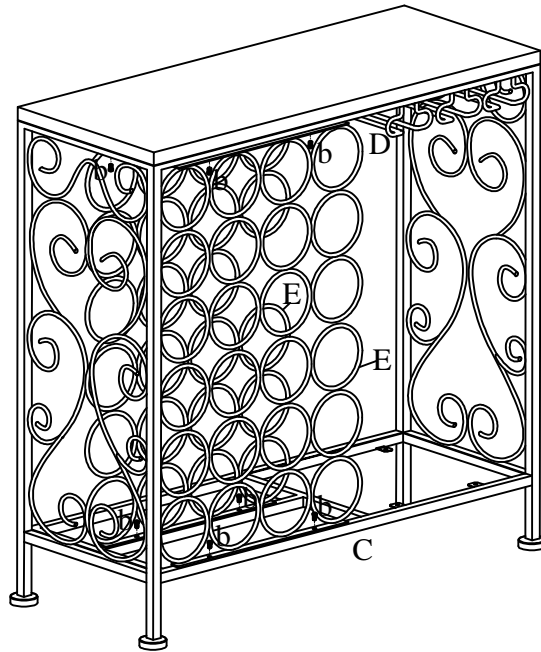

STEP 4

b  8pcs



Assemble Wine Holders (E) to Top Frame (D) and Bottom Frame (C) using Bolts (b). Please do not tighten Bolts (b) until step 5.

STEP 5

c  4pcs
b  2pcs

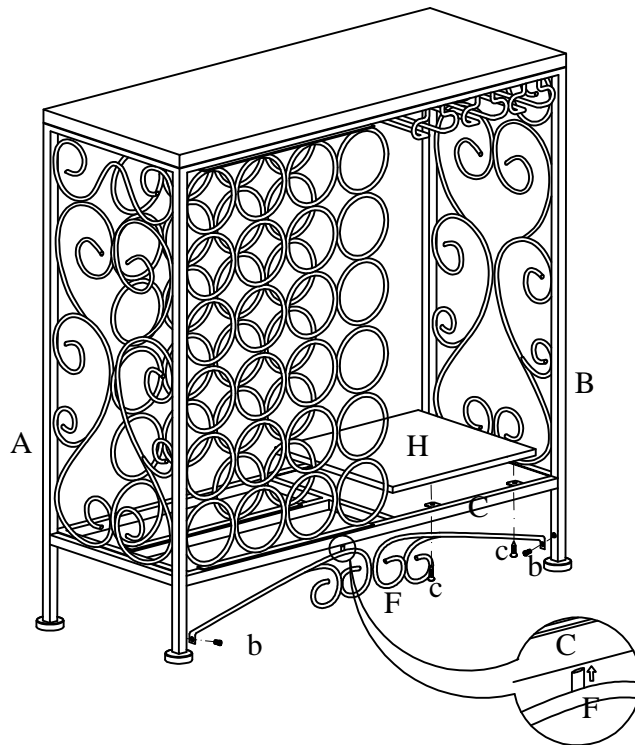

Assemble Bottom Panel (H) to Bottom Frame (C) using Screws (c).
Attach Connect Bar (F) to Side Frames (A&B) using Bolts (b).
Place the rack on the floor and check if it is stable before tightening all bolts.