

ASSEMBLY INSTRUCTIONS

Style # WR1345 Wine Rack

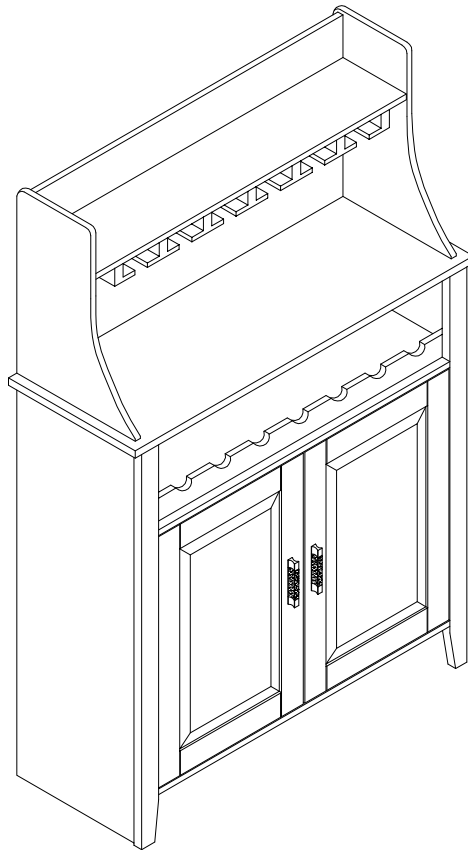

NOTE TO CUSTOMERS

- For ease and speed of assembly we recommend that before you commence each step of the assembly that you identify all the parts required to complete that step.
- We recommend that where possible you allow sufficient space to assemble the item as close as possible to the place where it will be once assembled.
- For the protection of your furniture we recommend that the product is placed on protected surfaces during assembly to prevent any damage.
- During assembly do not over tighten, as this may damage the product.
- Please ensure you retain all the product packaging until the item completely assembled.
- Please periodically check all fittings and re-tighten as necessary.
- Please never allow any liquids to remain on your furniture as absorption can cause the wood to warp or finish to de-laminate.
- It is recommended that this item should be assembled by two adults.

To use a cam lock: (Please read below instructions before assembling)

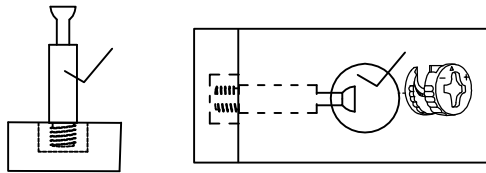

1. Insert cam screw into hole as shown in diagram A .

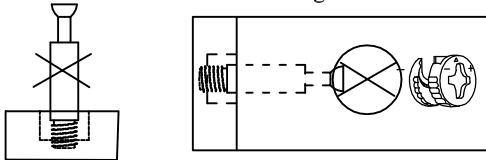

Diagram B

Make sure not to insert the cam screw:
Too deep as shown in figure B as this will cause the
cam screw to be misaligned and unable to
interlock properly.

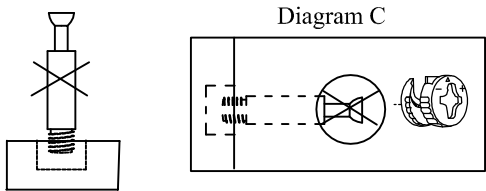
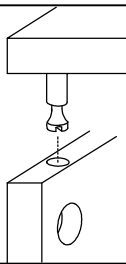
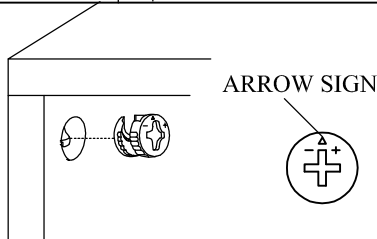

Diagram C

Also avoid inserting the cam screw too close to the
surface of the hole as shown in figure C, as this will
cause the cam lock to be too loose, and not interlock
properly.



2. Connect the panels together.



3. When inserting the cam lock make sure the arrow
of the cam lock faces the cam screw.

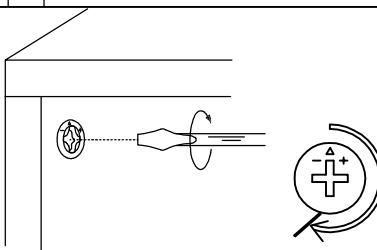

4. To tighten the cam lock turn the cam lock clockwise
90-180 degree or until the arrow is facing opposite
the place cam lock was inserted.

**NOTE: DO NOT USE AN AUTOMATIC
SCREWDRIVER TO TIGHTEN CAM LOCKS.**

Note:

- Read these instructions carefully before assembling.
- Tools required : Phillips screwdriver, flat screwdriver.
- Find a clean, smooth area on which to work , such as a carpet, in order to avoid scratching the wood surfaces.
- Wait to dispose of the packing material until assembly is complete and all parts and hardware are accounted for.
- Two or more people might be required for assembly.



WARNING:

**Serious or fatal crushing injuries can occur from furniture tip-over.
To help prevent tip-over:**

- Place heaviest item in the lowest drawers.
- Unless specifically designed to accommodate, do not set TVs or other heavy objects on top of this product.
- Never allow children to climb or hang on drawers, doors or shelves.
- Never open more than one drawer at a time.(OR)
- Do not defeat or remove the drawer interlock system.

Use of tip-over restraints may only reduce, but not eliminate the risk of tip-over.



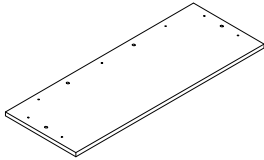
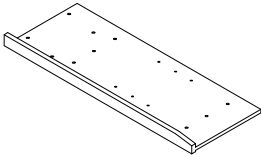
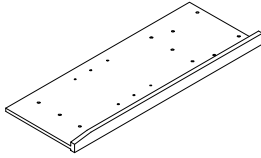
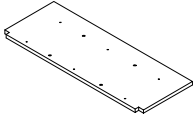
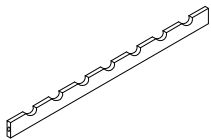
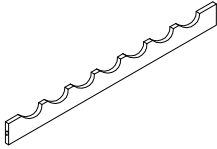
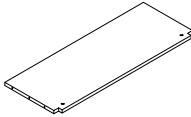
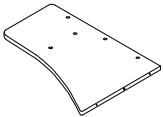

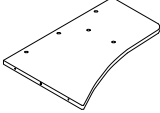
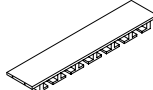
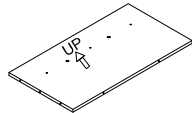
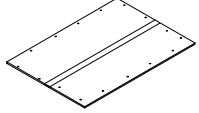
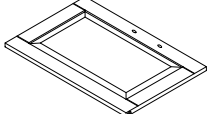
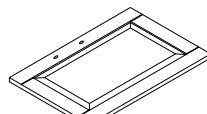
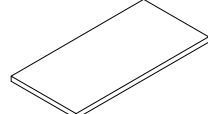

Part List

A1 Quantity of 1 	A2 Quantity of 1 	A3 Quantity of 1 	A4 Quantity of 1 
Top Panel	Lower Side Panel (Left)	Lower Side Panel (Right)	Divider
A5 Quantity of 1 	A6 Quantity of 1 	A7 Quantity of 1 	A8 Quantity of 1 
Front Connect Bar	Back Connect Bar	Bottom Panel	Upper Side Panel (Left)

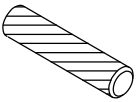
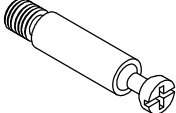
Part List

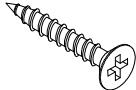
A9 Quantity of 1	A10 Quantity of 1	A11 Quantity of 1	A12 Quantity of 1
			
Upper Side Panel (Right)	Glass Holder	Upper Back Panel	Lower Back Panel
A13 Quantity of 1	A14 Quantity of 1	A15 Quantity of 1	
			
Door (Left)	Door (Right)	Adjustable Shelf	

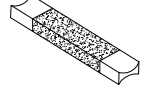
Hardware List

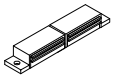
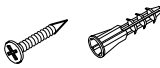
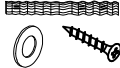

B1 Quantity of 20	B2 Quantity of 22	B3 Quantity of 22	B4 Quantity of 16
			
Wood Dowel	Cam-bolt	Cam-Lock	Screw
B5 Quantity of 4	B6 Quantity of 18	B7 Quantity of 2	B8 Quantity of 4
			
Shelf Support	Screw	Handle	Bolt
B9 Quantity of 1	B10 Quantity of 1	B11 Quantity of 1	
			
Magnet	Wall Anchor with Screw	Anti-tip Kit	

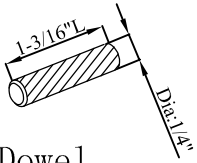
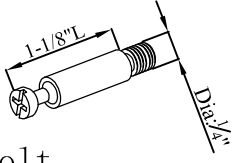
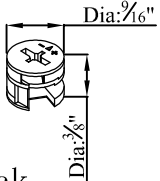
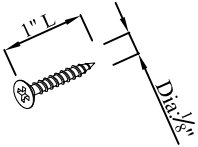
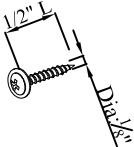
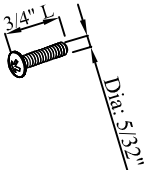
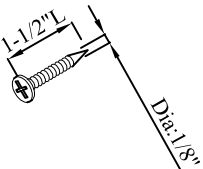
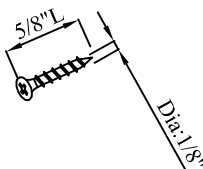
APPENDIX: Dimension of Hardwares in this AI.

<p>B1</p>  <p>Wood Dowel</p>	<p>B2</p>  <p>Cam-bolt</p>	<p>B3</p>  <p>Cam-lock</p>
<p>B4</p>  <p>Screw</p>	<p>B6</p>  <p>Screw</p>	<p>B8</p>  <p>Bolt</p>
<p>B10</p>  <p>Screw</p>	<p>B11</p>  <p>Screw</p>	

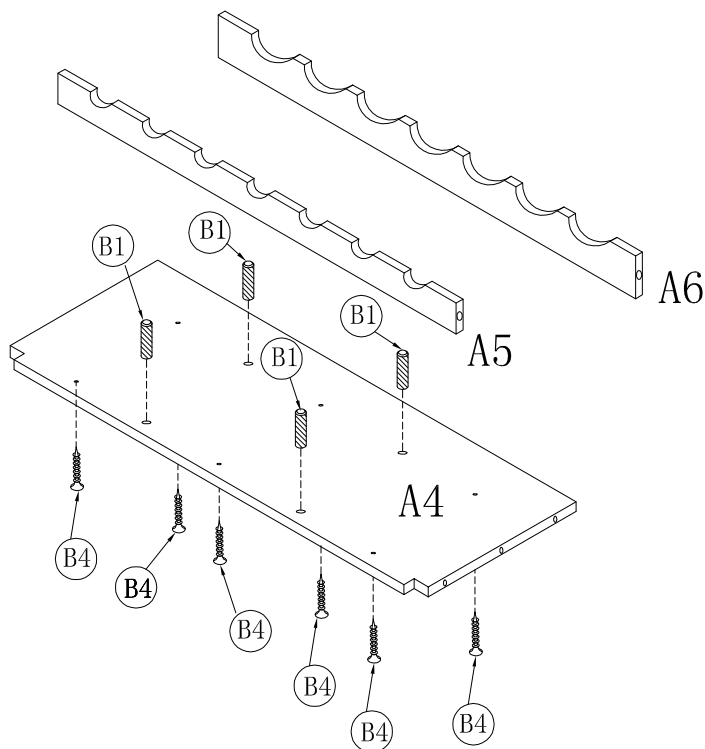

Step 1



B1		4pcs
B4		6pcs

Assemble Front Cross Bar (A5) and Back Cross Bar(A6) to Divider (A4) using Screws (B4) and Wood Dowels(B1).

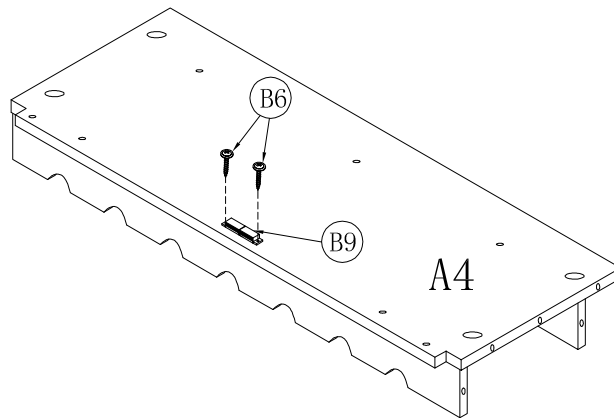

Step 2

B6		2pcs
B9		1pcs



Attach Magnet (B9) to the bottom of Divider (A4) using Screws (B6), please note the holes are pre-drilled.

Step 3

B1		4pcs
B2		12pcs

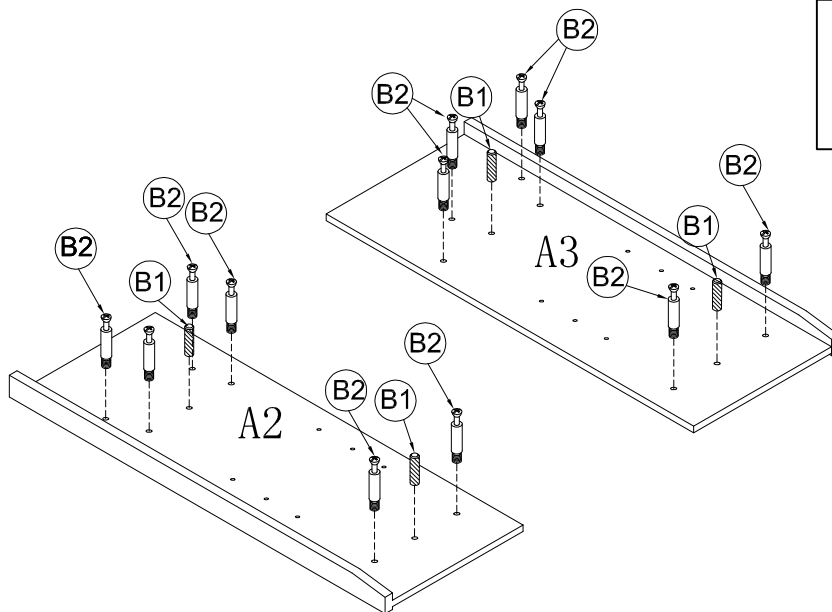

Insert Wood Dowels (B1) to the holes on Lower Side Panels (A2) &(A3). Then tighten Cam-bolts (B2) to Side Panels (A2) & (A3). Please note holes are pre-drilled.

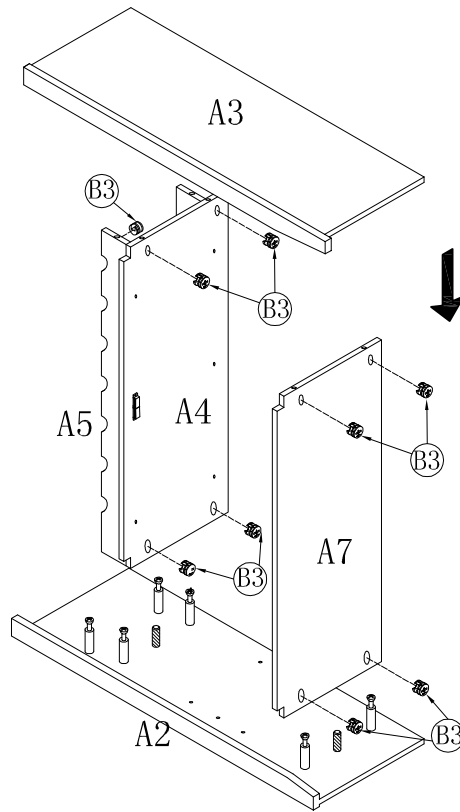

Step 4

B3  12pcs



Assemble Lower Side Panels (A2&A3) to Divider (A4), Bottom Panel (A7) and Cross Bar (A5&A6) inserting Cam Bolts(B2) & Wood Dowels (B1), insert Cam Locks (B3) into holes on the bottom of Divider (A4), Bottom Panel (A7) and Cross Bar (A5&A6), then tighten them.

Step 5

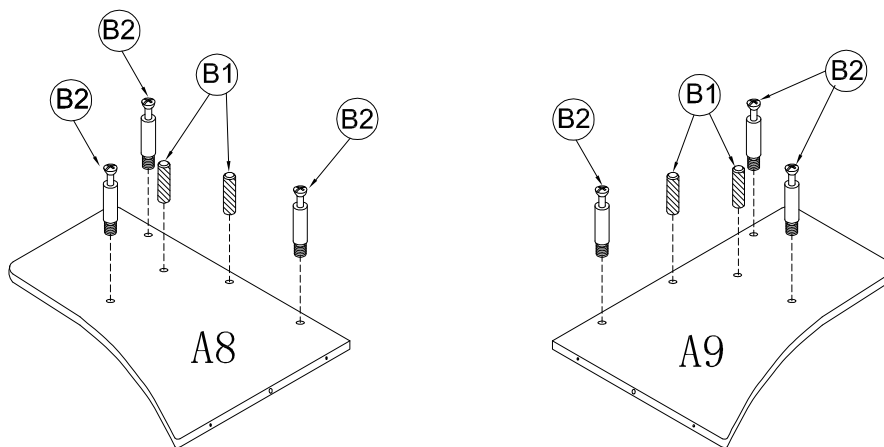

B1  4pcs
B2  6pcs

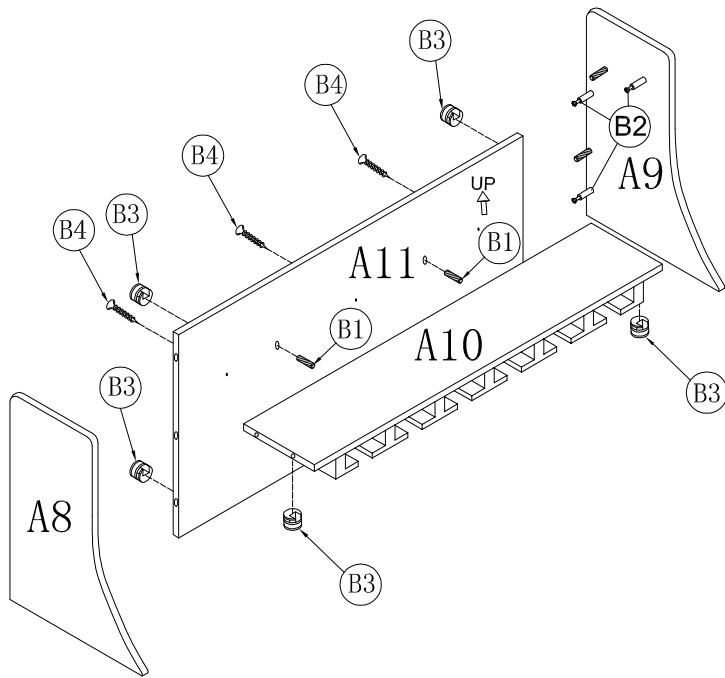

Insert Wood Dowels (B1) to the holes on Upper Side Panels (A8) &(A9). Then tighten Cam-bolts (B2) to Upper Side Panels (A8) & (A9). Please note holes are pre-drilled.

Step 6



B1		2pcs
B3		6pcs
B4		3pcs

1. Assemble Glass Holder (A10) to Upper Back Panel (A11) using Wood Dowels (B1) and Screws (B4).
2. Attach Upper Side Panel (A8)&(A9) to Upper Back Panel (A11) and Glass holder(A10) by inserting Cam-bolts (B2) and Wood Dowels (B1).
3. Insert Cam-locks (B3) into the holes on Upper Back Panel (A11) & Glass Holder (A10) , then tighten them.

Step 7

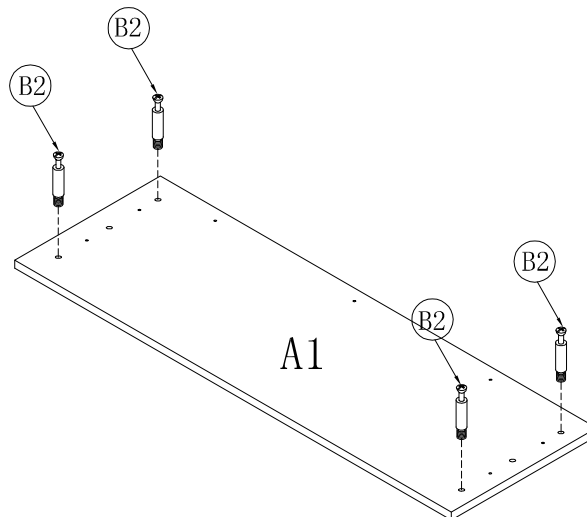

B2		4pcs
----	---	------

Insert Cam-bolts (B2) to holes on Top Panel (A1), then tighten them.

Step 8

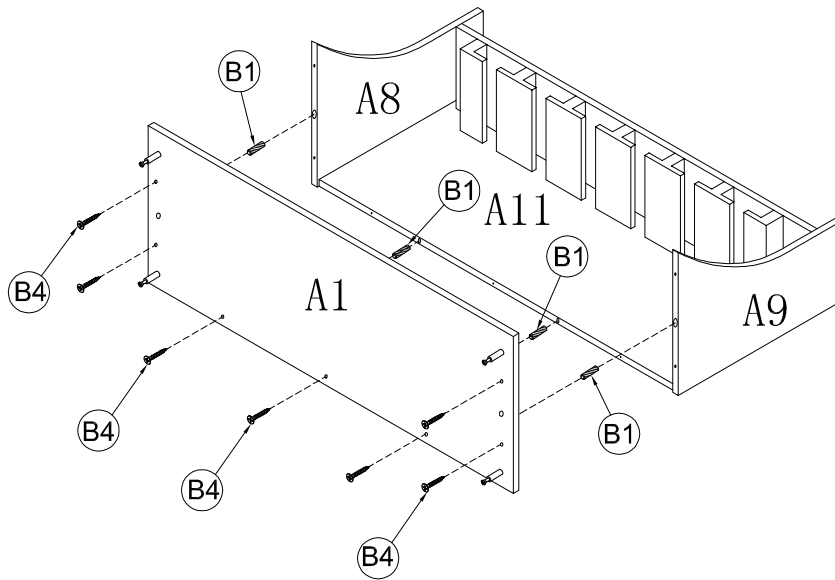

B1  4pcs

B4  7pcs

Assemble Top Panel (A1) to Upper Side Panels (A8) & (A9) and Upper Back Panel (A11) using Wood Dowels (B1) and Screws (B4) .

Step 9

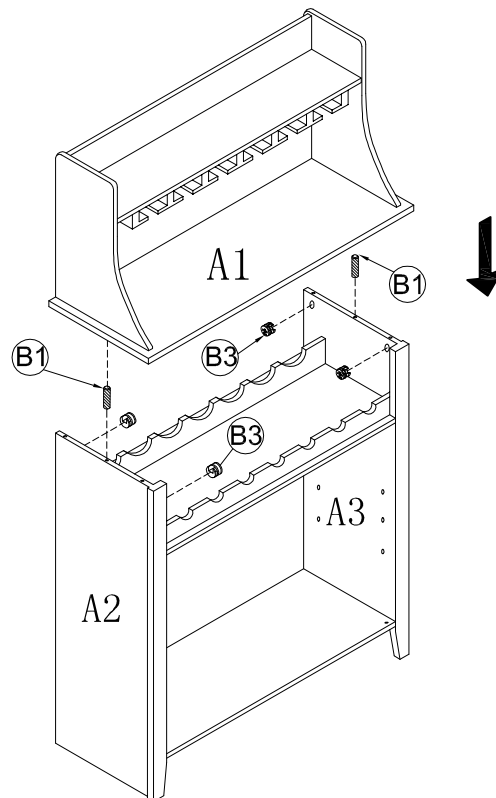

B1  2pcs

B3  4pcs

Assemble Top Panel (A1) to Lower Side Panels (A2) & (A3) by inserting Cam-bolts and using Wood Dowels (B1). Insert Cam Locks (B3) into holes on the Side panels (A2) & (A3) , then tighten them.

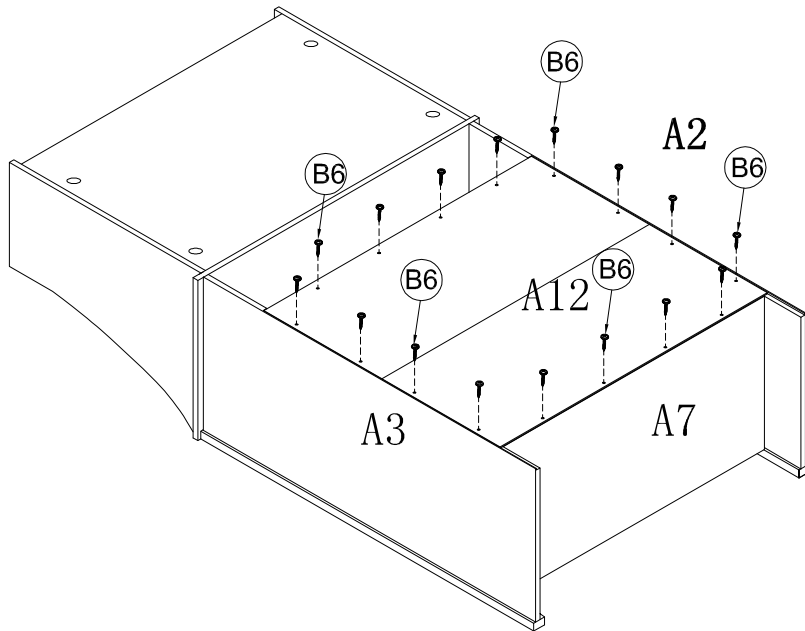

Step 10

B6  16pcs



Attach Lower Back Panels (A12) to Lower Side Panels (A2) & (A3), Divider (A4) and Bottom Panel (A7) using Screws (B6).

Step 11

B7  2pcs
B8  4pcs

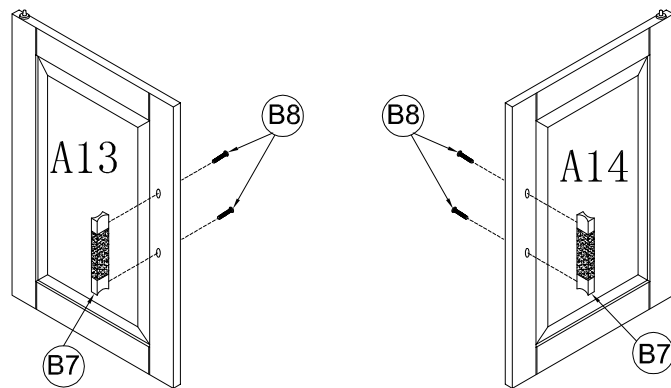

Attach Handles (B7) to Doors (A13) & (A14) using Bolts (B8).

Step 12

B5  4pcs

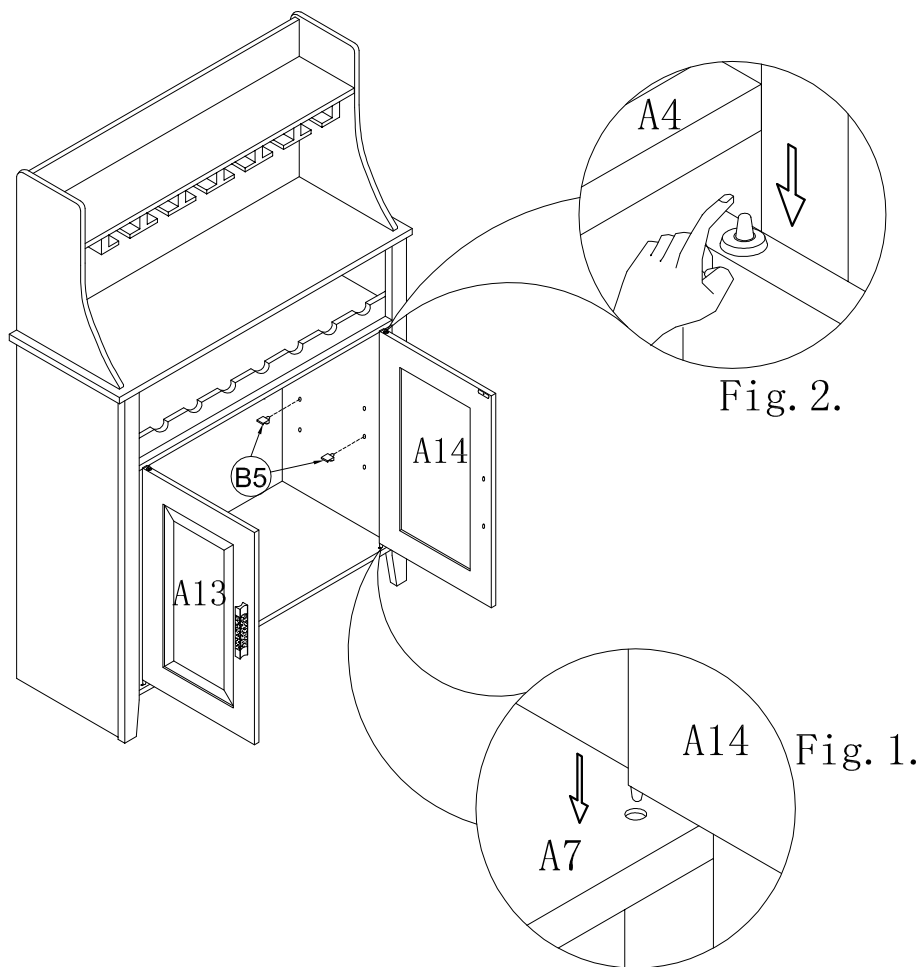

- 1: Connect Door (A14) to Bottom Panel (A7) as below Fig.1.
- 2: Press the upper pin on Door (A14) see Fig 2. and insert Door (A13) carefully into the cabinet with the upper pin popping up into the holes of Divider (A4).
- 3: Insert Shelf Support (B5) into the holes on Side Panels (A2) & (A3).

Step 13

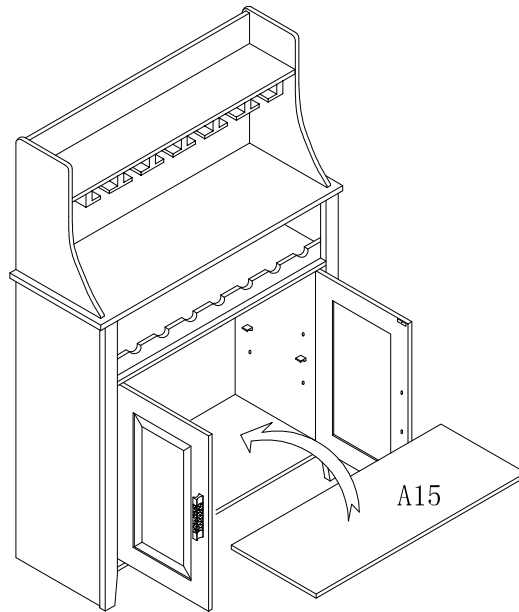

Attach Adjustable Shelf (A15) on Shelf Supports (B5).

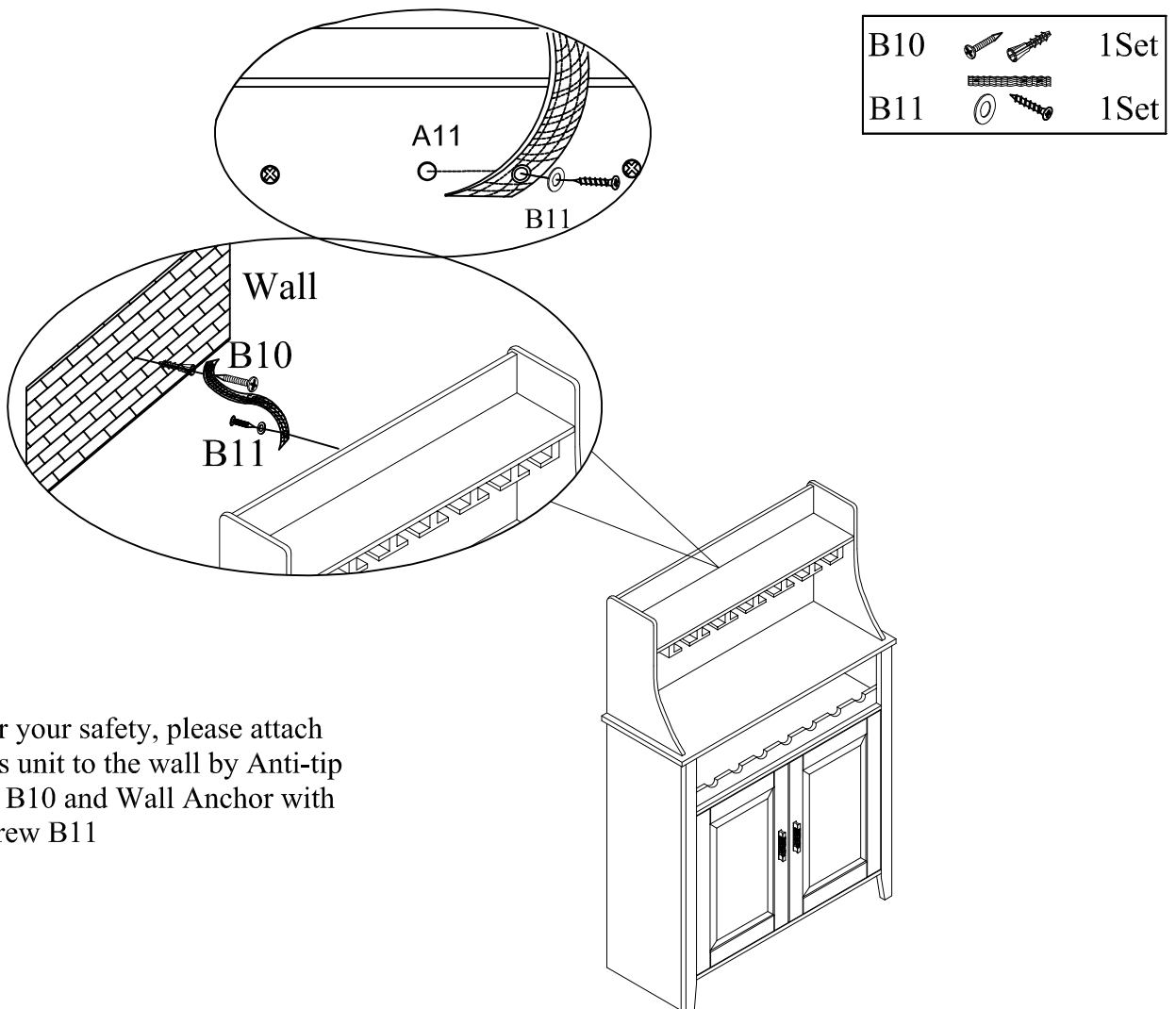

For your safety, please attach this unit to the wall by Anti-tip kit B10 and Wall Anchor with Screw B11