

ASSEMBLY INSTRUCTIONS

Style # SB-0635 Shoe Bench





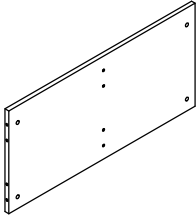
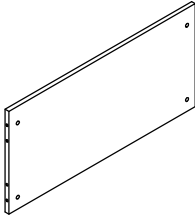
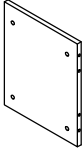
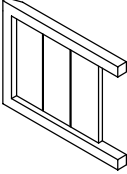
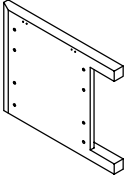
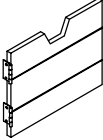
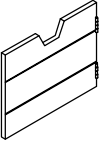
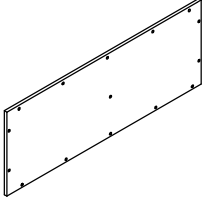

NOTE TO CUSTOMERS:

- For ease and speed of assembly we recommend that before you commence each step of the assembly that you identify all the parts required to complete that step.
- We recommend that where possible you allow sufficient space to assemble the item as close as possible to the place where it will be once assembled.
- For the protection of your furniture we recommend that the product is placed on protected surfaces during assembly to prevent any damage.
- During assembly do not over tighten, as this may damage the product.
- Please ensure you retain all the product packaging until the item completely assembled.
- Please periodically check all fittings and re-tighten as necessary.
- Please never allow any liquids to remain on your furniture as absorption can cause the wood to warp or finish to de-laminate.
- It is recommended that this item should be assembled by two adults.

PARTS LIST

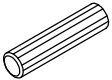
<p>TOP PANEL 1 PC</p>  <p style="text-align: right;">A</p>	<p>BOTTOM PANEL 1 PC</p>  <p style="text-align: right;">B</p>	<p>MIDDLE PANEL 1 PC</p>  <p style="text-align: right;">C</p>
<p>LEFT SIDE FRAME 1 PC</p>  <p style="text-align: right;">D</p>	<p>RIGHT SIDE FRAME 1 PC</p>  <p style="text-align: right;">E</p>	<p>LEFT DOOR 1 PC</p>  <p style="text-align: right;">F</p>
<p>RIGHT DOOR 1 PC</p>  <p style="text-align: right;">G</p>	<p>BACK PANEL 1 PC</p>  <p style="text-align: right;">H</p>	

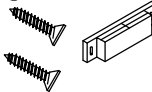
HARDWARE LIST

<p>WOOD DOWEL 12 PCS</p>  <p style="text-align: right;">1</p>	<p>CAM-BOLT CAM-LOCK 12 SETS</p>  <p style="text-align: right;">2</p>	<p>MAGNET LOCK ROUND HEAD SCREW 2 SETS</p>  <p style="text-align: right;">3</p>	<p>FLAT HEAD SCREW 8 PCS</p>  <p style="text-align: right;">4</p>	<p>ROUND HEAD SCREW 15 PCS</p>  <p style="text-align: right;">5</p>
--	--	--	--	--

Note:

- Read these instructions carefully before assembling.
- Tools required : Phillips screwdriver, flat screwdriver.
- Find a clean, smooth area on which to work , such as a carpet, in order to avoid scratching the wood surfaces.
- Wait to dispose of the packing material until assembly is complete and all parts and hardware are accounted for.
- Two or more people might be required for assembly.

To use Dowels:

1. Add glue (about ¼ full) in the hole(s) of each board to be joined.
1. Insert the Dowel(s) and join boards.
2. Wipe excess glue with a damp paper towel.

To use Cam Locks:

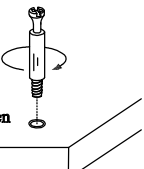
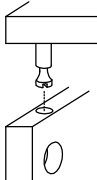
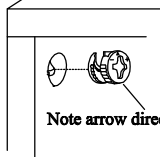
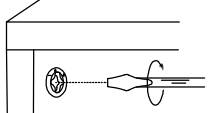
<p>1. Insert Cam Pin until snug</p>  <p><small>Do not over-tighten</small></p>	<p>2. Set boards together</p> 	<p>3. Insert Cam Lock</p>  <p><small>Note arrow direction</small></p>	<p>4. Turn Cam Lock clockwise (half a turn)</p>  <p><small>if it won't turn halfway, back out the Cam Pin ¼ turn and try Cam Lock again.</small></p>
---	---	---	---

STEP 1: ASSEMBLE TOP PANEL (A), BOTTOM PANEL (B) AND MIDDLE PANEL (C)

- Use flat head screws (3) to attach magnet locks (3) onto the bottom of top panel (A).
- Use wood dowels (1) and cam-bolts & cam-locks (2) to assemble top panel (A), bottom panel (B) and middle panel (C) together.

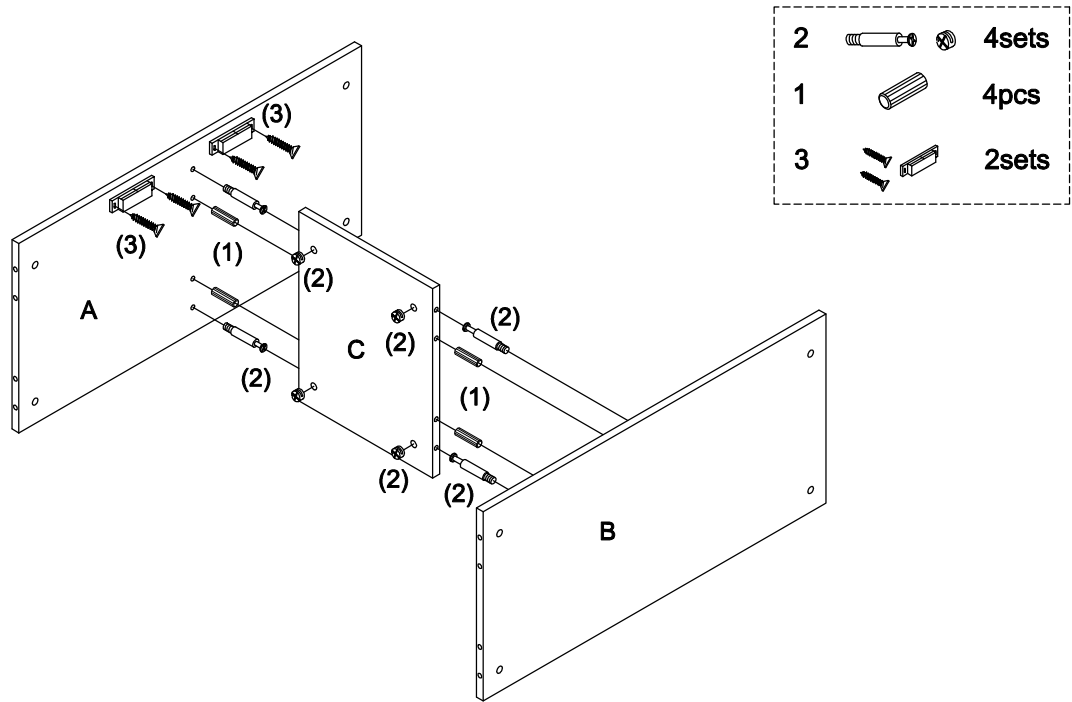

STEP 2: ASSEMBLE SIDE FRAME (D & E), TOP PANEL (A) AND BOTTOM PANEL (B)

- Use wood dowels (1) and cam-bolts & cam-locks (2) to assemble side frames (D & E), top panel (A) and bottom panel (B) together.

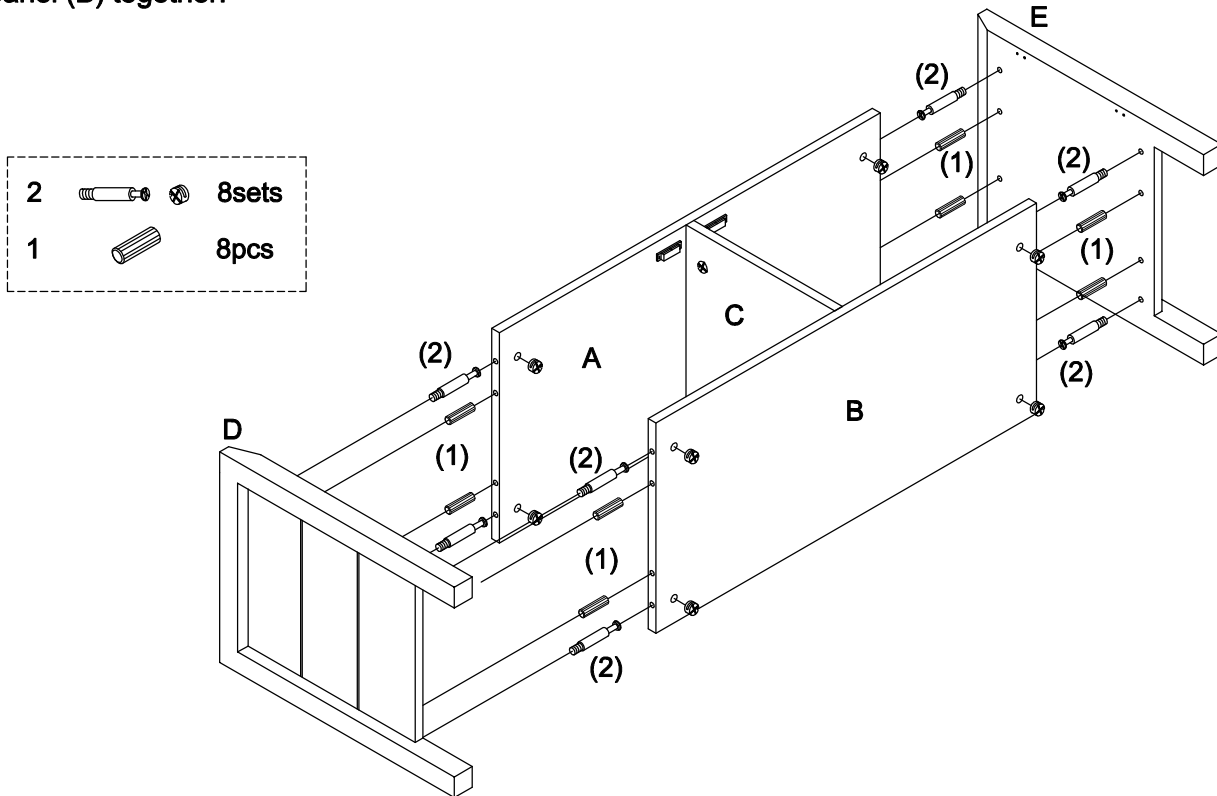

STEP 3: ASSEMBLE BACK PANEL (H)

- Use round head screws (5) to attach back panel (H) on the back of pre-assembled unit.

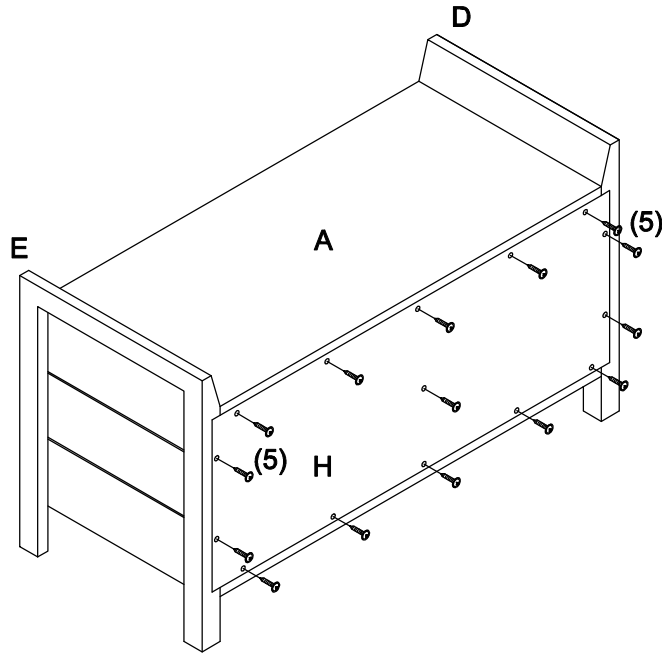

STEP 4: ASSEMBLE DOOR (F & G)

- Use flat head screws (4) to assemble doors (F & G) onto side frames (D & E).

