

ASSEMBLY INSTRUCTIONS

Style # SB-0633 Shoe Bench

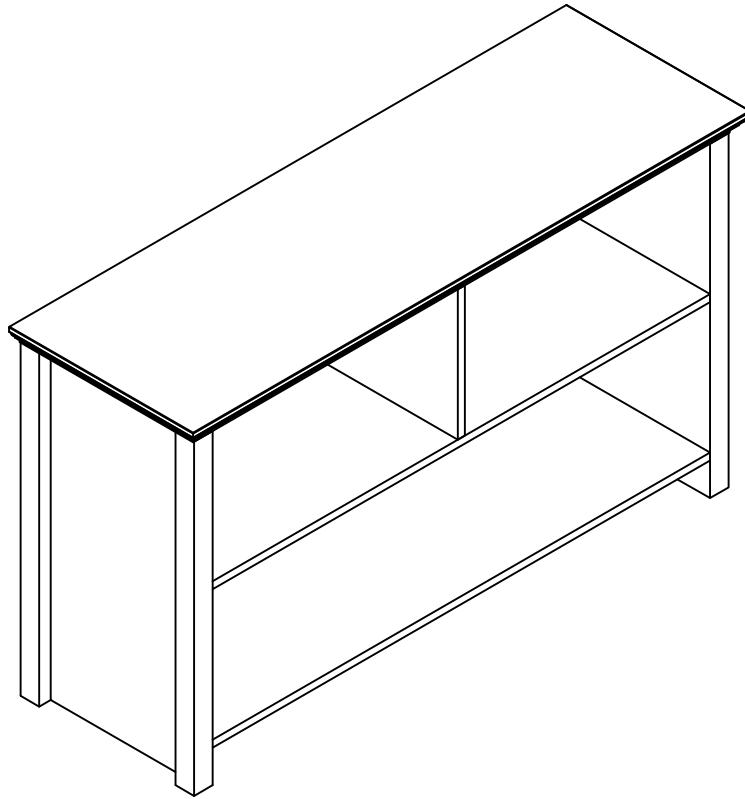



NOTE TO CUSTOMERS:

- For ease and speed of assembly we recommend that before you commence each step of the assembly that you identify all the parts required to complete that step.
- We recommend that where possible you allow sufficient space to assemble the item as close as possible to the place where it will be once assembled.
- For the protection of your furniture we recommend that the product is placed on protected surfaces during assembly to prevent any damage.
- During assembly do not over tighten, as this may damage the product.
- Please ensure you retain all the product packaging until the item completely assembled.
- Please periodically check all fittings and re-tighten as necessary.
- Please never allow any liquids to remain on your furniture as absorption can cause the wood to warp or finish to de-laminate.
- It is recommended that this item should be assembled by two adults.

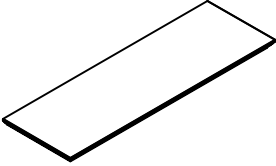
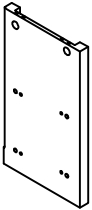
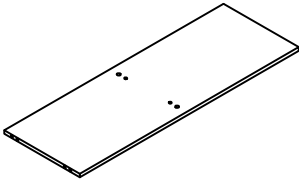
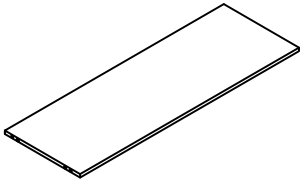
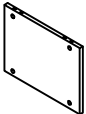
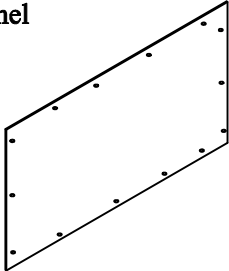
PARTS LIST

Top Panel 1 PC  <div style="text-align: right;">A1</div>	Side Panel 2 PCS  <div style="text-align: right;">A2 (L&R)</div>	Shelf 1 PC  <div style="text-align: right;">A3</div>
Bottom Panel 1 PC  <div style="text-align: right;">A4</div>	Divider 1 PC  <div style="text-align: right;">A5</div>	Back Panel 1PC  <div style="text-align: right;">A6</div>

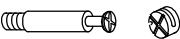
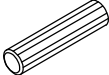
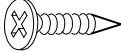
HARDWARE LIST

Camlock 16 SETS  <div style="text-align: right;">B1</div>	Wood Dowel 16 PCS  <div style="text-align: right;">B2</div>	Screw 14 PCS  <div style="text-align: right;">B3</div>	Glue 1 PC  <div style="text-align: right;">B4</div>
--	--	---	--

Note:

- Read these instructions carefully before assembling.
- Tools requirh area on which to work , such as a carpet, in order to avoid scratching the wood surfaces.
- Wait to dispose of the packied : Phillips screwdriver, flat screwdriver.
- Find a clean, smootng material until assembly is complete and all parts and hardware are accounted for.
- Two or more people might be required for assembly.

To use Dowels:

1. Add glue (about ¼ full) in the hole(s) of each board to be joined.
1. Insert the Dowel(s) and join boards.
2. Wipe excess glue with a damp paper towel.

To use Cam Locks:

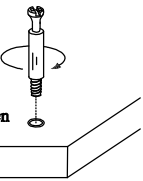
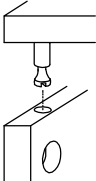
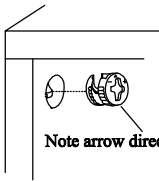
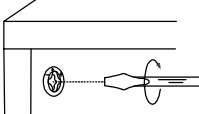
1. Insert Cam Pin until snug  Do not over-tighten	2. Set boards together 	3. Insert Cam Lock  Note arrow direction	4. Turn Cam Lock clockwise (half a turn)  if it won't turn halfway, back out the Cam Pin ¼ turn and try Cam Lock again.
---	--	---	---

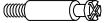

Step 1: Assemble Divider A5 to Shelf A3 using Camlocks B1 and Wood Dowels B2.

B1:   2SETS

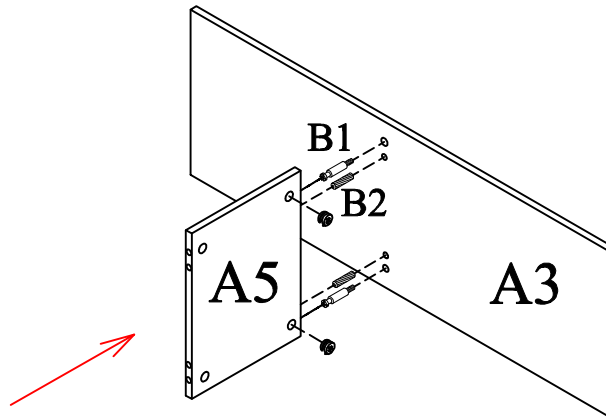
B2:  2PCS





Step 2: Assemble Shelf A3 and Bottom Panel A4 to Side Panels A2 using Camlocks B1 and Wood Dowels B2.

B1:   8SETS

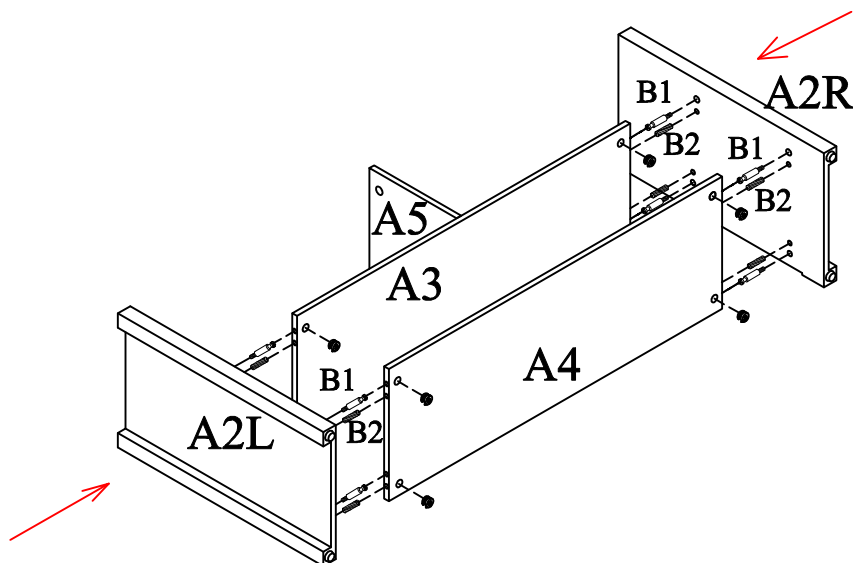
B2:  8PCS

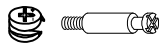

Step 3: Assemble Top Panel A1 to Side Panels A2 and Divider A5 using Camlocks B1 and Wood Dowels B2.

B1:		6SETS
B2:		6PCS

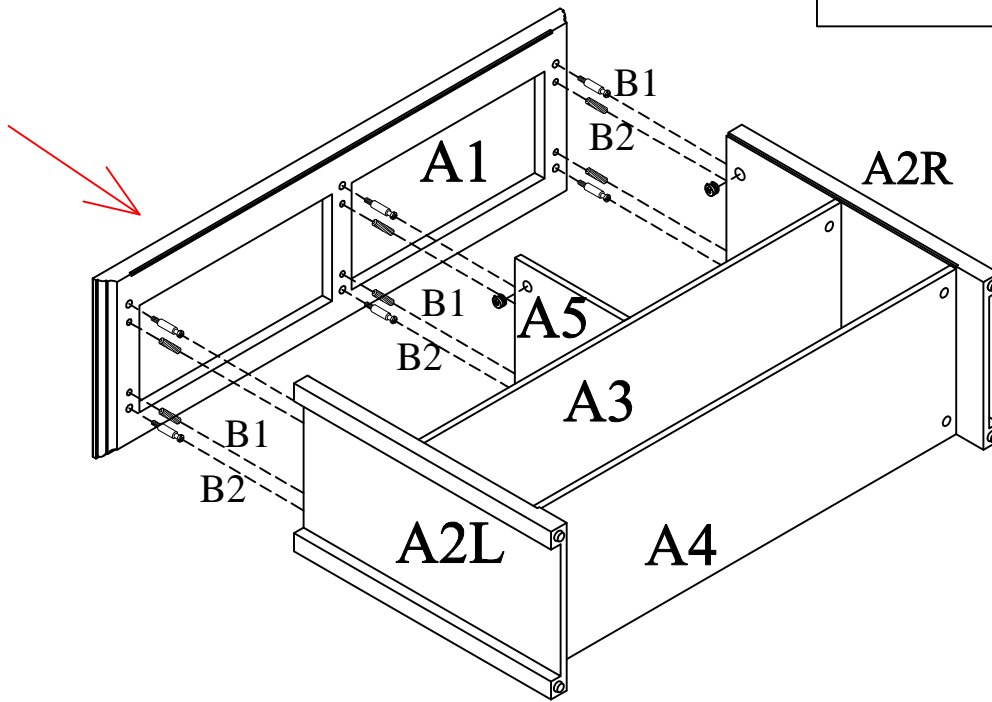

Step 4: Assemble Back Panel A6 to this unit using Screws B3.

B3:		14PCS
-----	---	-------

