

# ASSEMBLY INSTRUCTIONS

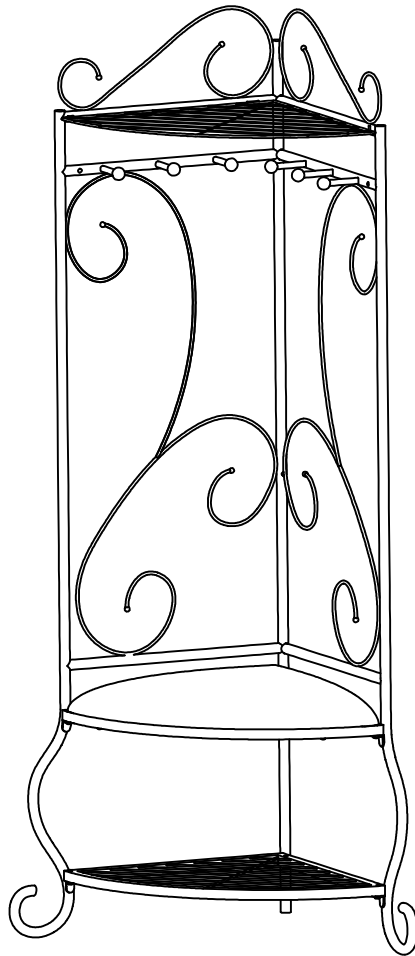



## Style # M09 Corner Hallway Bench



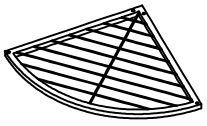
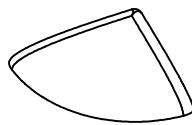
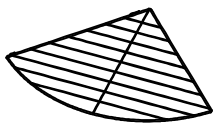
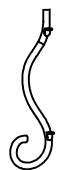

### NOTE TO CUSTOMERS:

- For ease and speed of assembly we recommend that before you commence each step of the assembly that you identify all the parts required to complete that step.
- We recommend that where possible you allow sufficient space to assemble the item as close as possible to the place where it will be once assembled.
- For the protection of your furniture we recommend that the product is placed on protected surfaces during assembly to prevent any damage.
- During assembly do not over tighten, as this may damage the product.
- Please ensure you retain all the product packaging until the item completely assembled.
- Please periodically check all fittings and re-tighten as necessary.
- Please never allow any liquids to remain on your furniture as absorption can cause the wood to warp or finish to de-laminate.
- It is recommended that this item should be assembled by two adults.

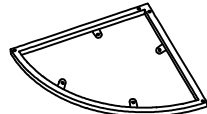
# Part List

<p>A1</p>  <p>Left Frame</p> <p>1pc</p>	<p>A2</p>  <p>Right Frame</p> <p>1pc</p>	<p>A3</p>  <p>Bottom Shelf</p> <p>1pc</p>
<p>A4</p>  <p>Seat Panel</p> <p>1pc</p>	<p>A5</p>  <p>Top Shelf</p> <p>1pc</p>	<p>A6</p>  <p>Left Leg</p> <p>1pc</p>
<p>A7</p>  <p>Back Leg</p> <p>1pc</p>	<p>A8</p>  <p>Right Leg</p> <p>1pc</p>	<p>A9</p>  <p>Seat Frame</p> <p>1pc</p>

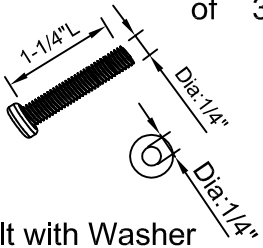
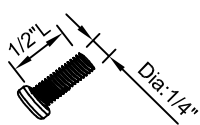
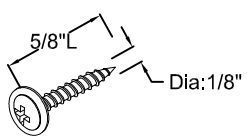
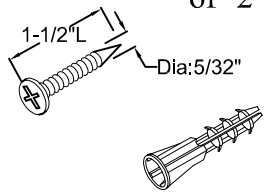
# Hardware List

<p>B1</p>  <p>Quantity of 3</p> <p>Bolt with Washer</p>	<p>B2</p>  <p>Quantity of 14</p> <p>Bolt</p>	<p>B3</p>  <p>Quantity of 4</p> <p>Screw</p>	<p>B4</p>  <p>Quantity of 2</p> <p>Screw with Anchor</p>
<p>Quantity of 1</p>  <p>Allen Key</p>			

## STEP 1

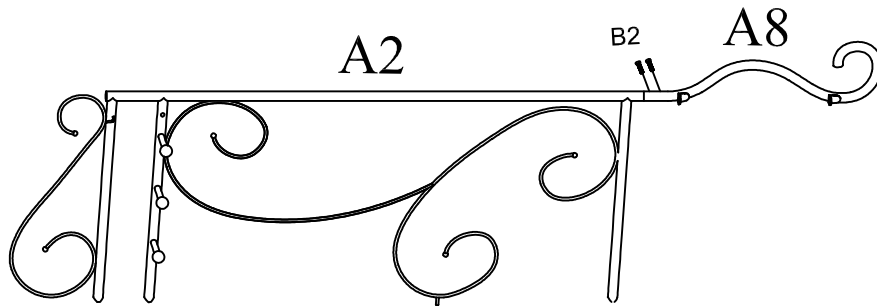
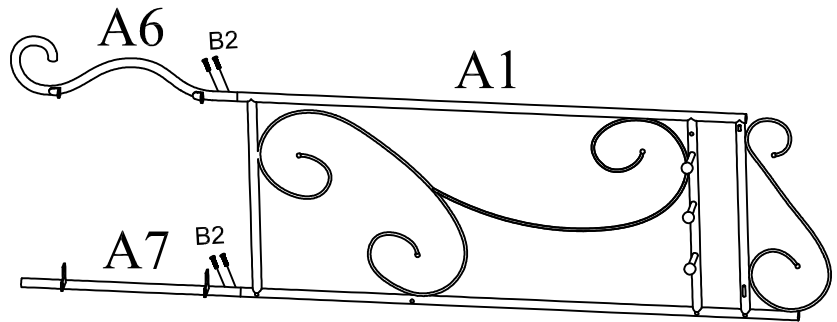
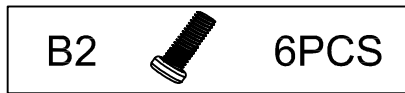

- 1).Assemble Left Leg A6 and Back Leg A7 to Left Frame A1 using Bolts B2.
  - 2).Assemble Right Leg A8 to Right Frame A2 using Bolts B2.
- Note: Please do not tighten Bolts B2 until step 6.

## STEP 2

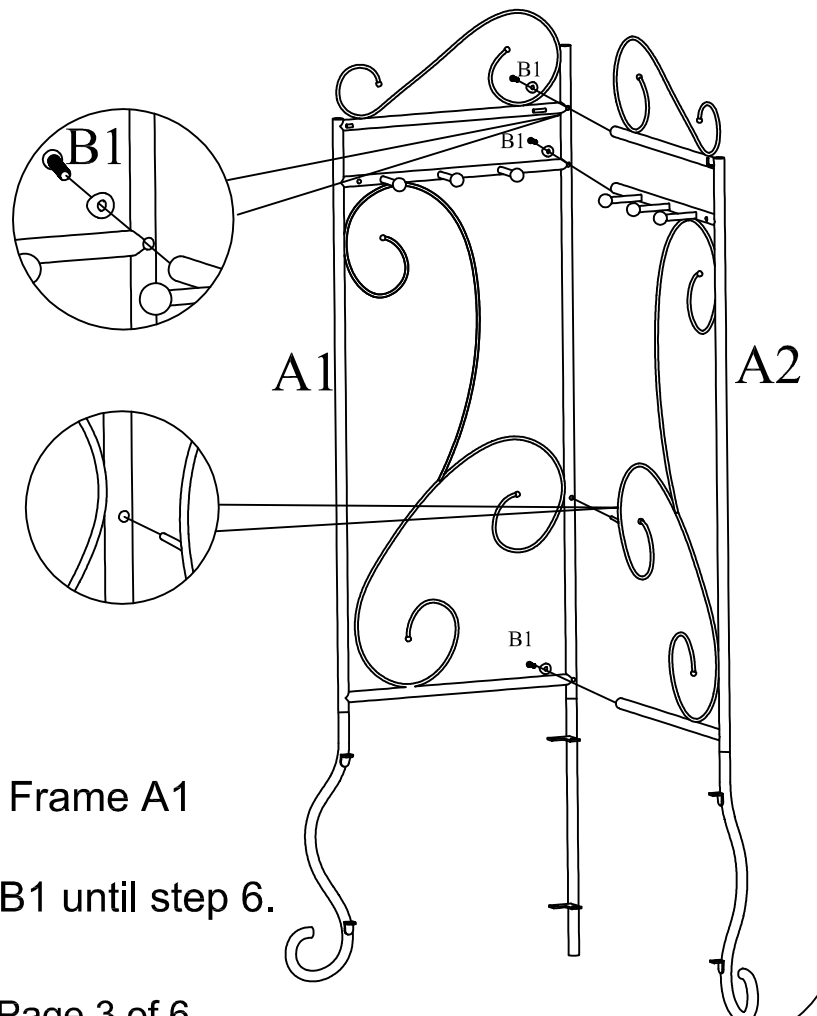
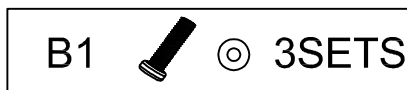

- Assemble Right Frame A2 to Left Frame A1 using Bolts with washers B1.
- Note: Please do not tighten Bolts B1 until step 6.

## STEP 3

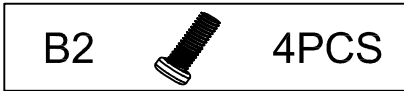

Assemble Bottom Shelf A3 to Left Leg A6, Back Leg A7 and Right Leg A8 using Bolts B2.  
Note: Please do not tighten Bolts B2 until Step 6.

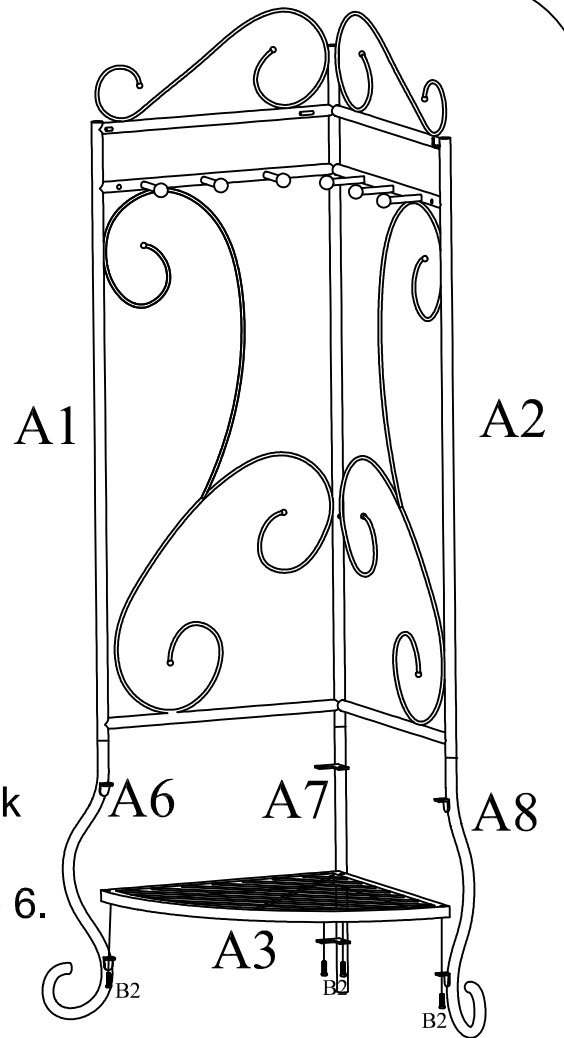

## STEP 4

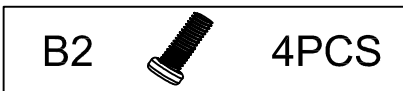

Assemble Seat Frame A9 to Left Leg A6, Back Leg A7 and Right Leg A8 using Bolts B2.  
Note: Please do not tighten Bolts B2 until Step 6.

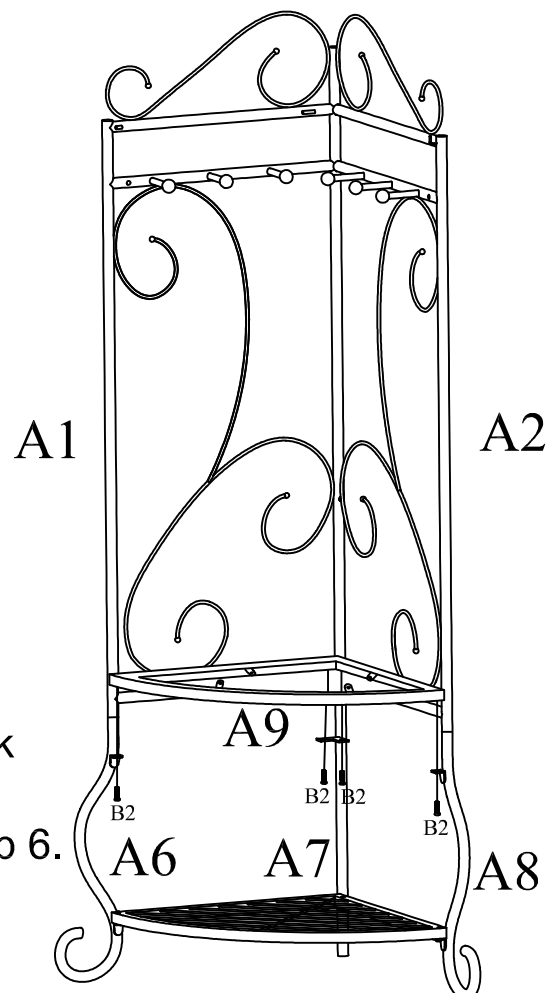

## STEP 5

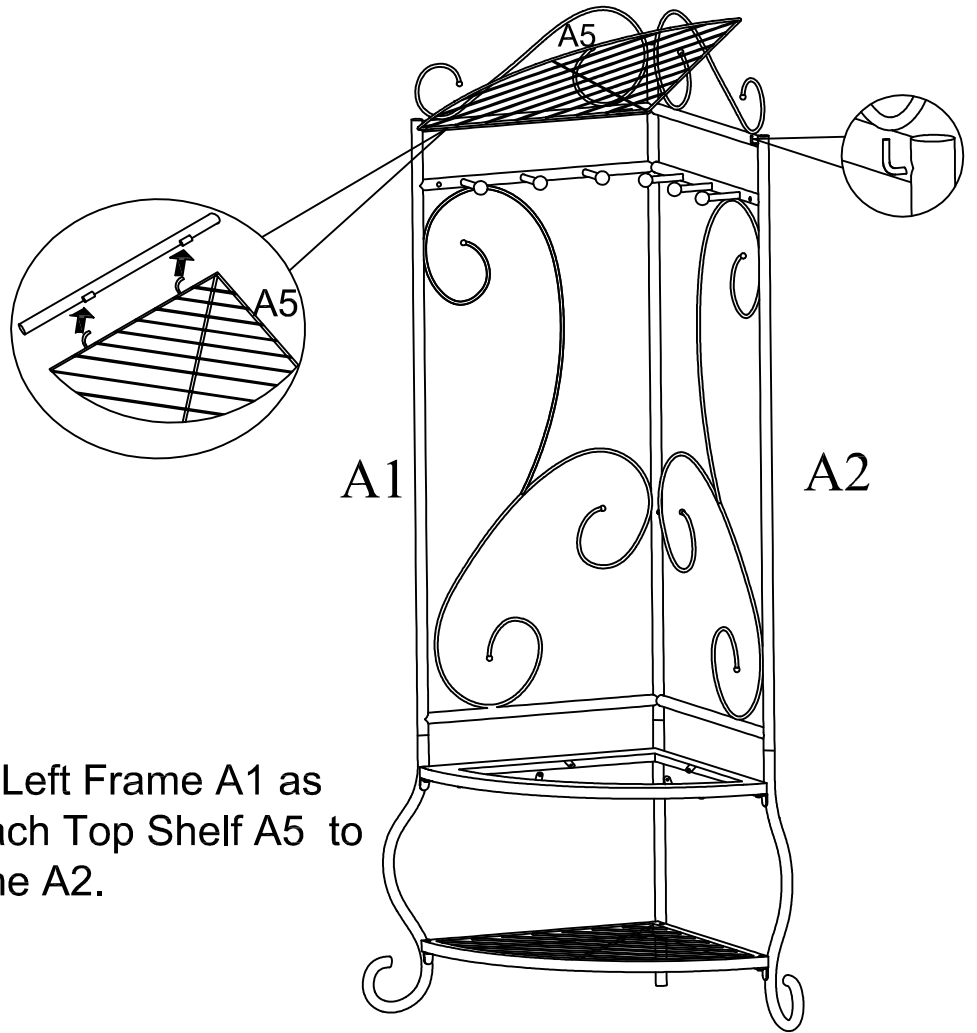

Attach Top Shelf A5 to Left Frame A1 as shown above, then Attach Top Shelf A5 to the hook on Right Frame A2.

## STEP 6

B3  4PCS

- 1). Assemble Seat Panel A4 to Seat Frame A9 using Screws B3.
- 2). Place the rack on the floor and check if it is stable before tightening all Bolts B1&B2.

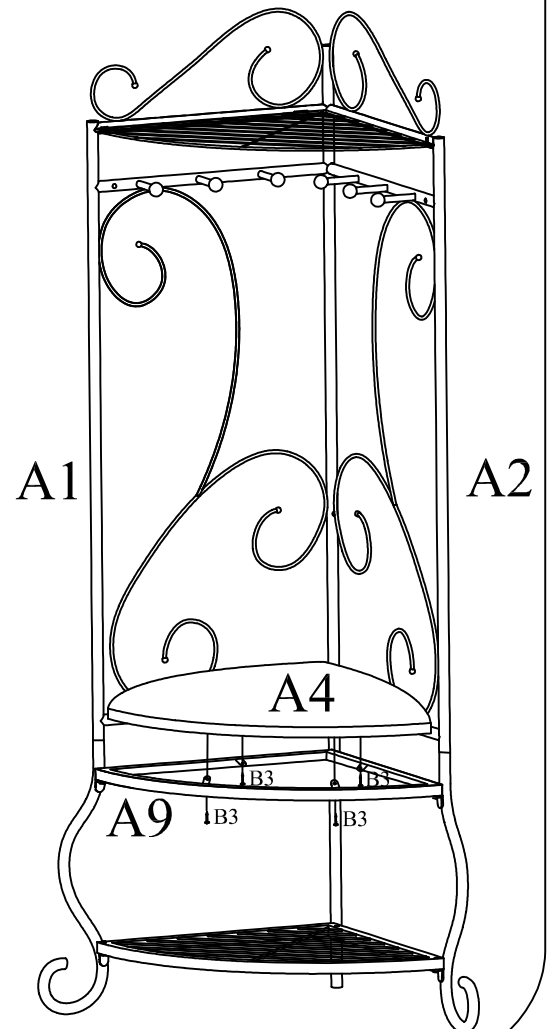

## STEP 7

B4  2SETS

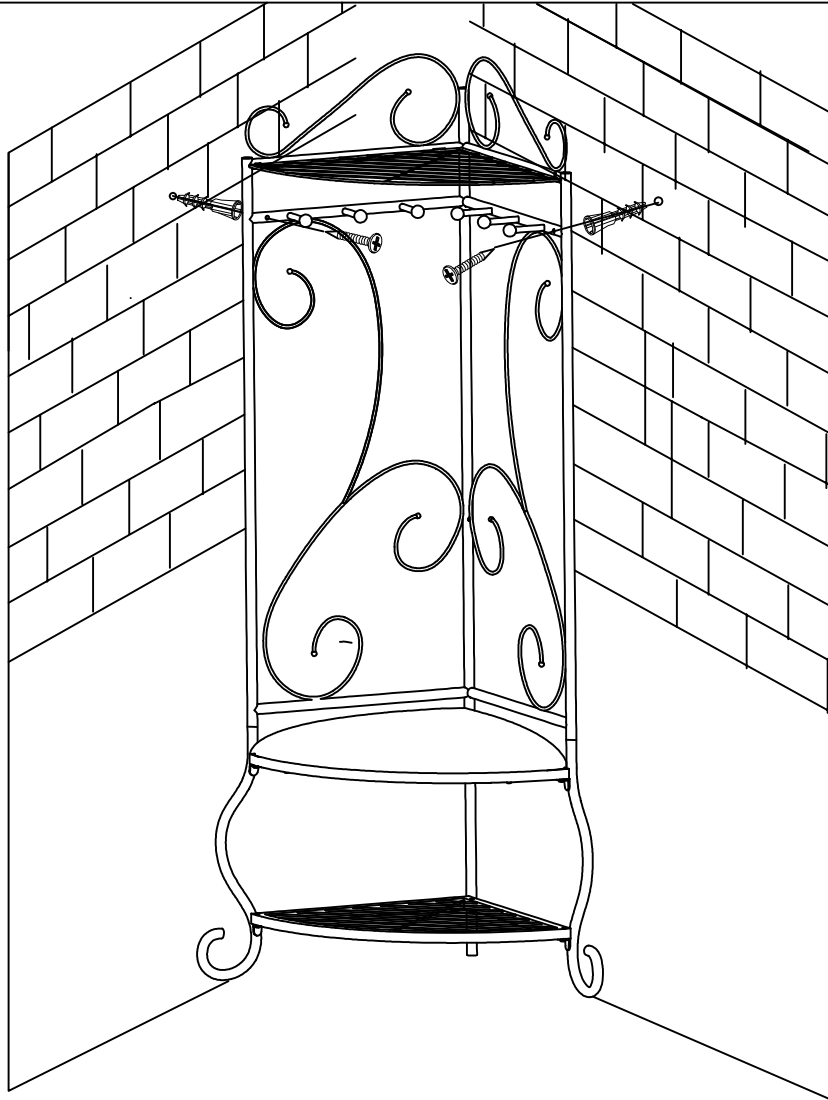

For your safety, please fix the corner hallway bench to the wall by Anchors and Screws B4.