

Assembly Instructions

Style# LRK161 Luggage Rack

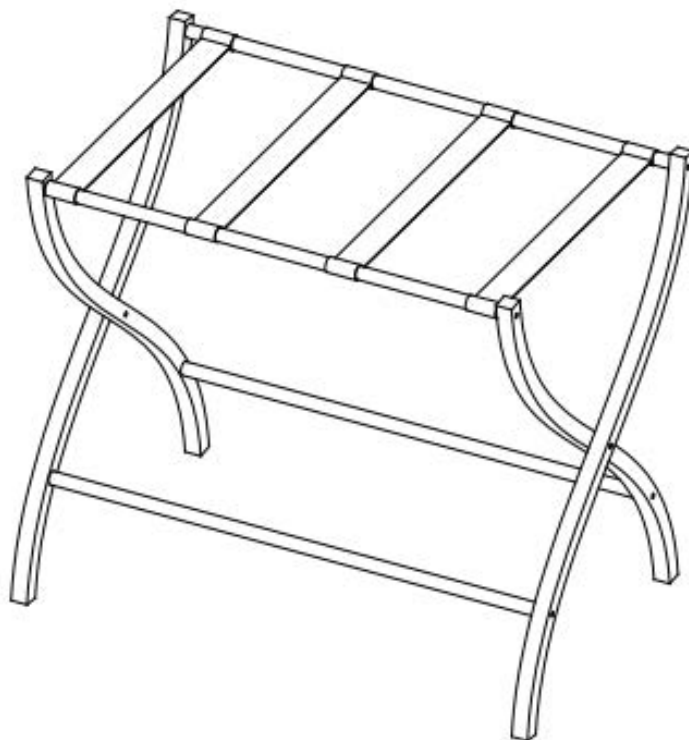



NOTE TO CUSTOMERS:

- For ease and speed of assembly we recommend that before you commence each step of the assembly that you identify all the parts required to complete that step.
- We recommend that where possible you allow sufficient space to assemble the item as close as possible to the place where it will be once assembled.
- For the protection of your furniture we recommend that the product is placed on protected surfaces during assembly to prevent any damage.
- During assembly do not to over tighten, as this may damage the product.
- Please ensure you retain all the product packaging until the item completely assembled.
- Please periodically check all fittings and re-tighten as necessary.
- Never allow any liquids to remain on your furniture as absorption can cause the wood to warp or finish to de-laminate.
- It is recommended that this item should be assembled by two adults.

ASSEMBLY INSTRUCTIONS

Style# LRK161 Luggage Rack

NO.	QTY
1	1 PCS
2	1 PCS
3	1 PCS
4	4 PCS

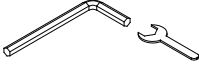
NO.	Description	QTY
A+B		2 SETS
C		8 PCS
D		2 PCS
E+F		1 SET

Note: Please do not tighten all Bolts A&B until all of them are attached.

ASSEMBLY TOOLS REQUIRED

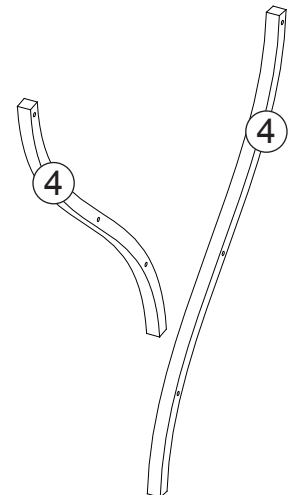
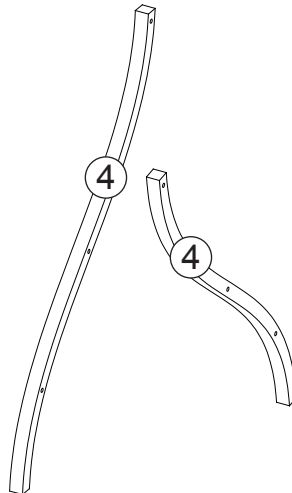
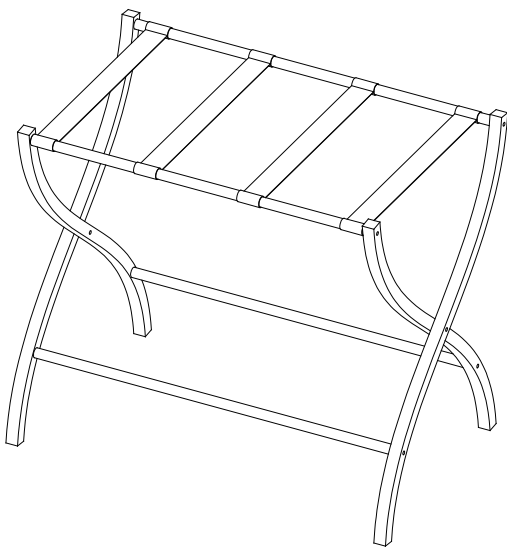
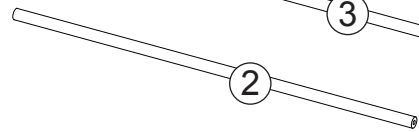
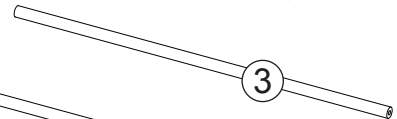
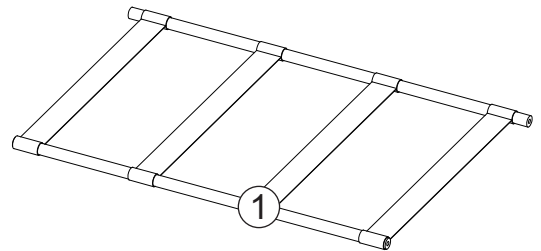

Step 1

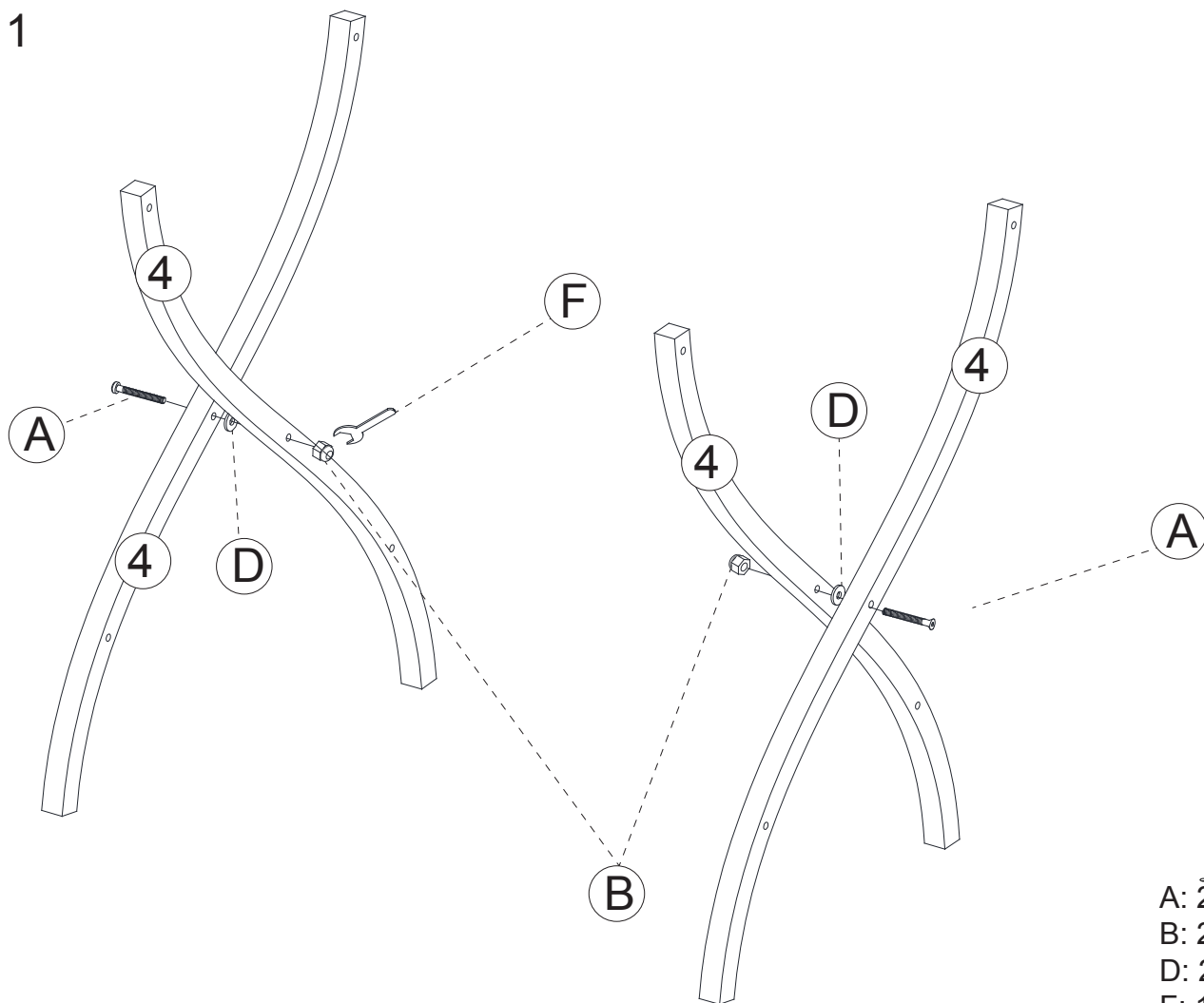

Step 2

