

# ASSEMBLY INSTRUCTIONS

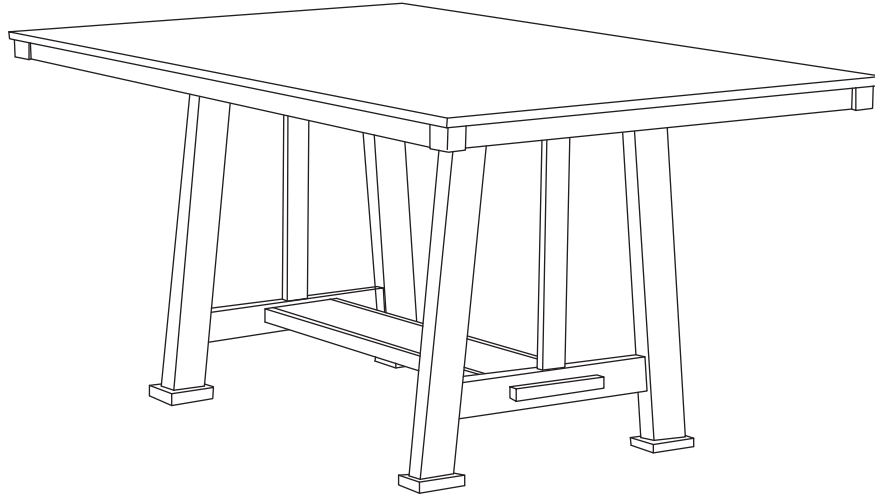

## MODEL #D4218-T : DINING TABLE







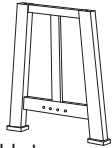
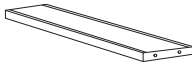



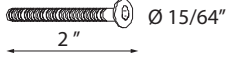
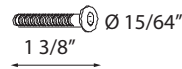

### NOTE TO CUSTOMERS:

- For ease and speed of assembly we recommend that before you commence each step of the assembly that you identify all the parts required to complete that step.
- We recommend that where possible you allow sufficient space to assemble the item as close as possible to the place where it will be once assembled.
- For the protection of your furniture we recommend that the product is placed on a dry, soft, smooth and clean surfaces during assembly to prevent any damage. Avoid damp and direct sunlight.
- During assembly do not over tighten the screws or bolts, as this may damage the product.
- Please ensure you retain all the product packaging until the item is completely assembled.
- Periodically check all fitting and re-tighten as necessary.
- Never allow any liquids to remain on your furniture as absorption can cause the wood to warp or finish to de-laminate.
- It is recommended that this item should be assembled by two adults.

## PARTS IDENTIFICATION

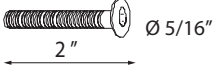
P1 Quantity: 1  Table Top	P2 Quantity: 2  Trestle Table Legs	P3 Quantity: 1  Shelf Stretcher	P4 Quantity: 2  Mounting Bar	P5 Quantity: 2  Cap Cleats
--	--	---	---	--

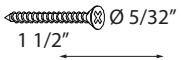
## HARDWARE LISTS

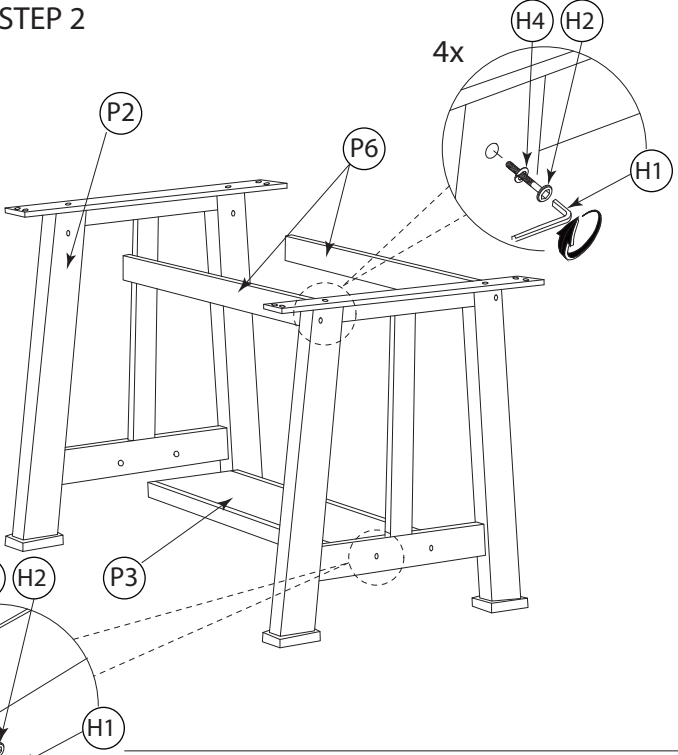
P6 Quantity: 2  Support Rails	H1 Allen Key M4 Quantity: 1 pc 	H2 JCBC Bolts M6 x 50mm Quantity: 8 pcs 	H3 JCBC Bolts M6 x 35mm Quantity: 10 pcs 	H4 Spring Washer 1/4" Quantity: 18 pcs 
H5 Flat Washer 1/4" Quantity: 18 pcs 	H6 Allen Key M5 Quantity: 1 pc 	H7 JCBB Bolts M8 x 50mm Quantity: 4 pcs 	H8 Spring Washer 5/16" Quantity: 4 pcs 	H9 Flat Washer 5/16" Quantity: 4 pcs 
H10 Screw M4 x 38mm Quantity: 8 pcs 	H11 Wood Button Quantity: 4 pcs 	<b>STEP 2</b> 		

### STEP 1 For both Legs

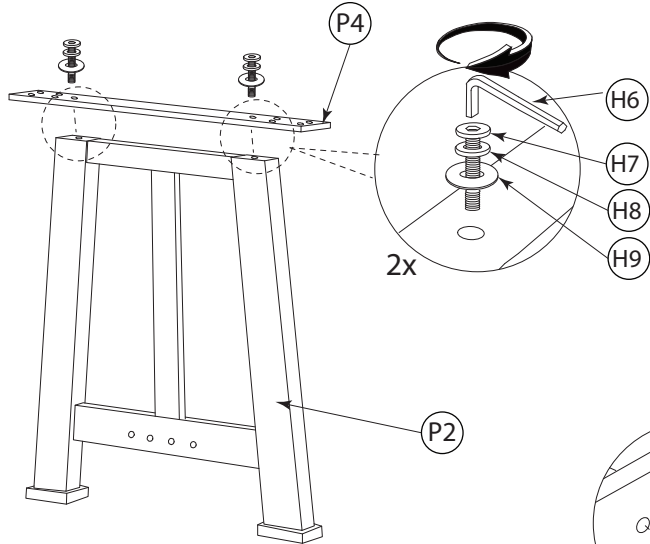

### STEP 3

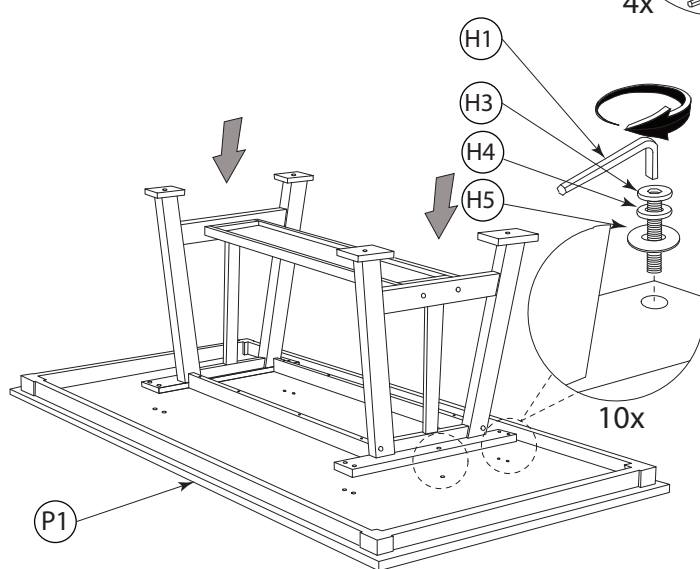

### STEP 4

