

# ASSEMBLY INSTRUCTIONS

Style # CU1440/CU1441 Curio

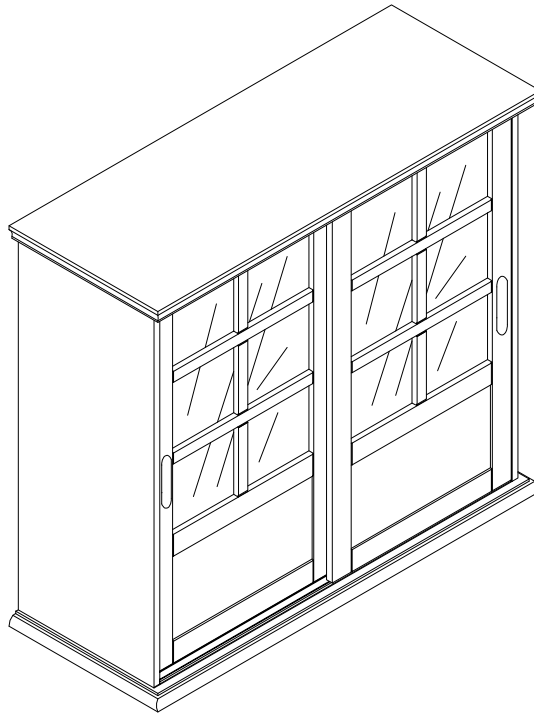



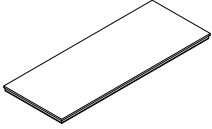
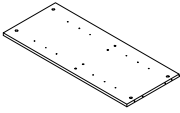
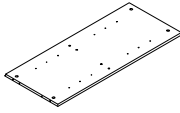
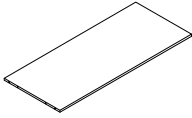
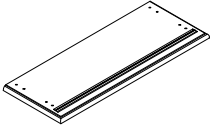
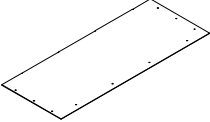
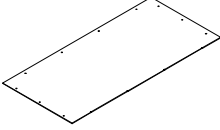
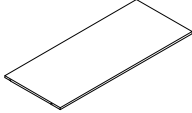
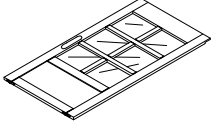
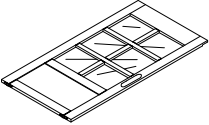

## NOTE TO CUSTOMERS:

- For ease and speed of assembly we recommend that before you commence each step of the assembly that you identify all the parts required to complete that step.
- We recommend that where possible you allow sufficient space to assemble the item as close as possible to the place where it will be once assembled.
- For the protection of your furniture we recommend that the product is placed on protected surfaces during assembly to prevent any damage.
- During assembly do not over tighten, as this may damage the product.
- Please ensure you retain all the product packaging until the item completely assembled.
- Please periodically check all fittings and re-tighten as necessary.
- Please never allow any liquids to remain on your furniture as absorption can cause the wood to warp or finish to de-laminate.
- It is recommended that this item should be assembled by two adults.

## Part List

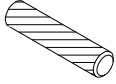
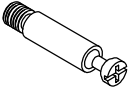
<p>A. <span style="float: right;">Quantity of 1</span></p>  <p>Top Panel</p>	<p>B. <span style="float: right;">Quantity of 1</span></p>  <p>Side Panel (Left)</p>	<p>C. <span style="float: right;">Quantity of 1</span></p>  <p>Side Panel (Right)</p>	<p>D. <span style="float: right;">Quantity of 1</span></p>  <p>Divider</p>
<p>E. <span style="float: right;">Quantity of 1</span></p>  <p>Bottom Panel</p>	<p>F. <span style="float: right;">Quantity of 1</span></p>  <p>Back Panel</p>	<p>G. <span style="float: right;">Quantity of 1</span></p>  <p>Back Panel</p>	<p>H. <span style="float: right;">Quantity of 2</span></p>  <p>Adjustable Shelf</p>
<p>I. <span style="float: right;">Quantity of 1</span></p>  <p>Door (Left)</p>	<p>J. <span style="float: right;">Quantity of 1</span></p>  <p>Door (Right)</p>		

## Hardware List

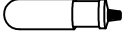
<p>(1) <span style="float: right;">Quantity of 12</span></p>  <p>Wood Dowel</p>	<p>(2) <span style="float: right;">Quantity of 12</span></p>  <p>Cam-bolt</p>	<p>(3) <span style="float: right;">Quantity of 12</span></p>  <p>Cam-Lock</p>	<p>(4) <span style="float: right;">Quantity of 8</span></p>  <p>Shelf Support</p>
<p>(5) <span style="float: right;">Quantity of 24</span></p>  <p>Screw</p>	<p>(6) <span style="float: right;">Quantity of 1</span></p>  <p>Glue</p>		

## Note:

- Read these instructions carefully before assembling.
- Tools required : Phillips screwdriver, flat screwdriver.
- Find a clean, smooth area on which to work , such as a carpet, in order to avoid scratching the wood surfaces.
- Wait to dispose of the packing material until assembly is complete and all parts and hardware are accounted for.
- Two or more people might be required for assembly.

## To use Dowels:

1. Add glue (about  $\frac{1}{4}$  full ) in the hole(s) of each board to be joined.
2. Insert the Dowel(s) and join boards.
3. Wipe excess glue with a damp paper towel.

## To use Cam Locks:

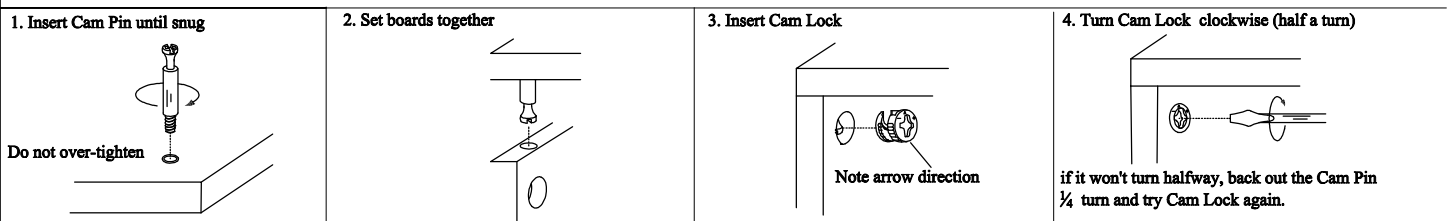

# STEP 1

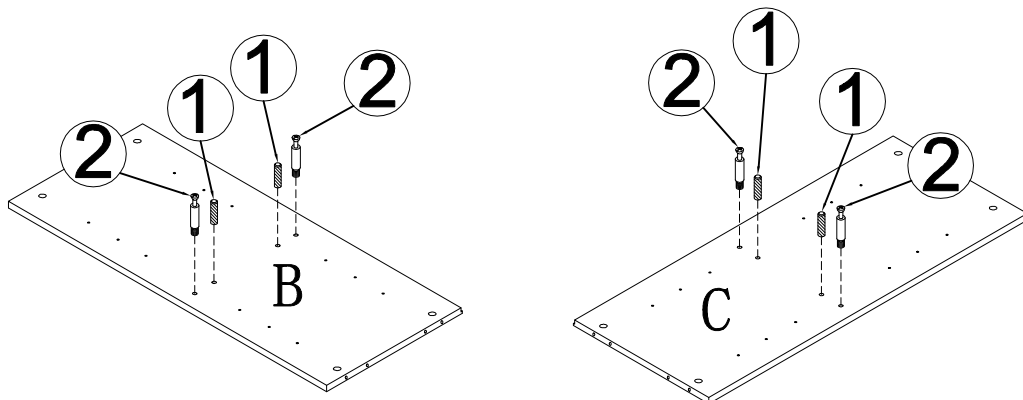
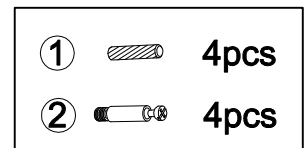

Insert Wood Dowels (1) and Cam-bolts (2) into the holes on Side Panels (B&C), then tighten Cam-bolts (2).

## STEP 2

③  4pcs

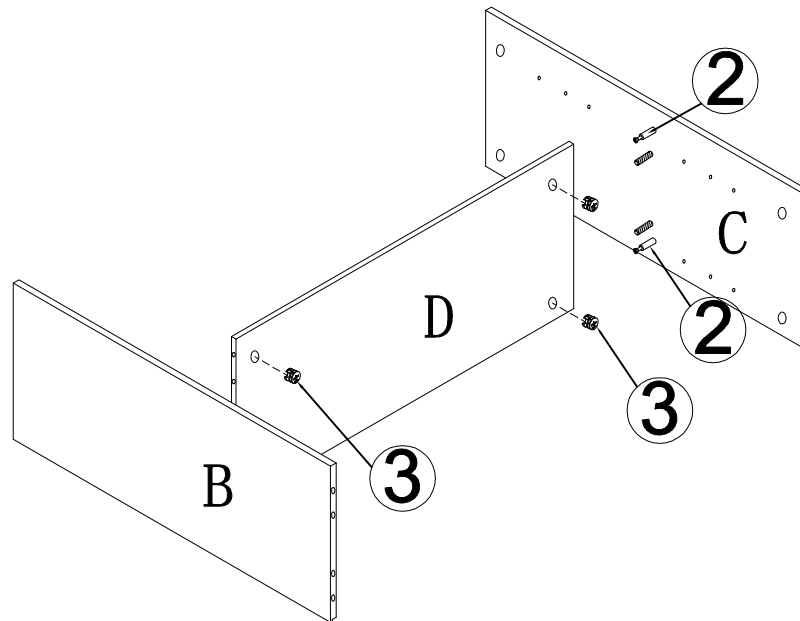

Attach Side Panels (B&C) to Divider (D), then using Cam-locks (3) to catch inserted Cam-bolts (2) on Side Panels (B&C).

## STEP 3

①  8pcs

②  8pcs

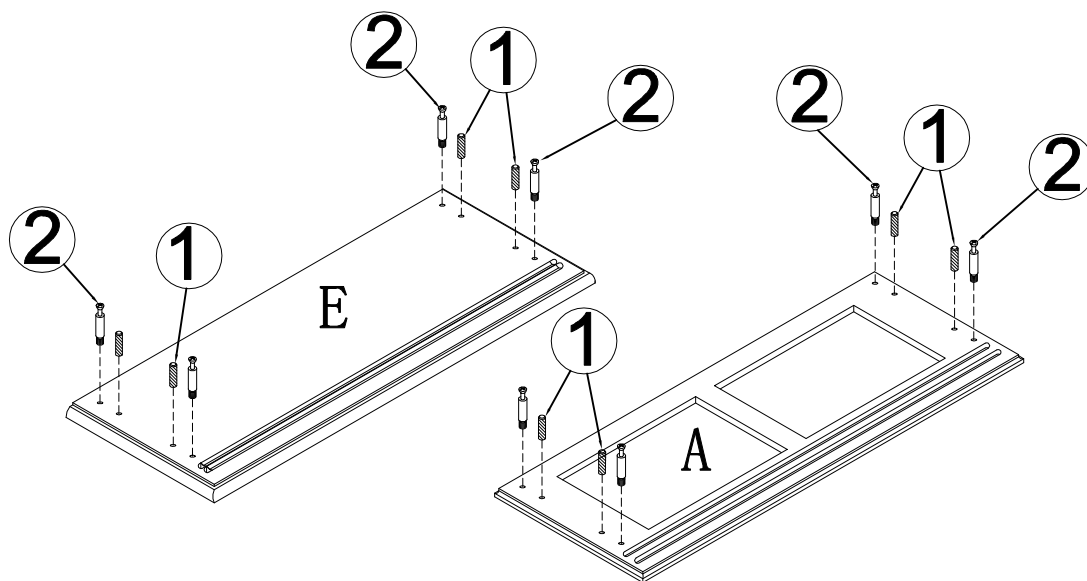

Insert Wood Dowels (1) and Cam-bolts (2) into the holes on Top Panel (A) and Bottom Panel (E), then tighten Cam-bolts (2).

## STEP 4

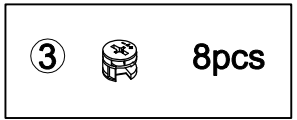
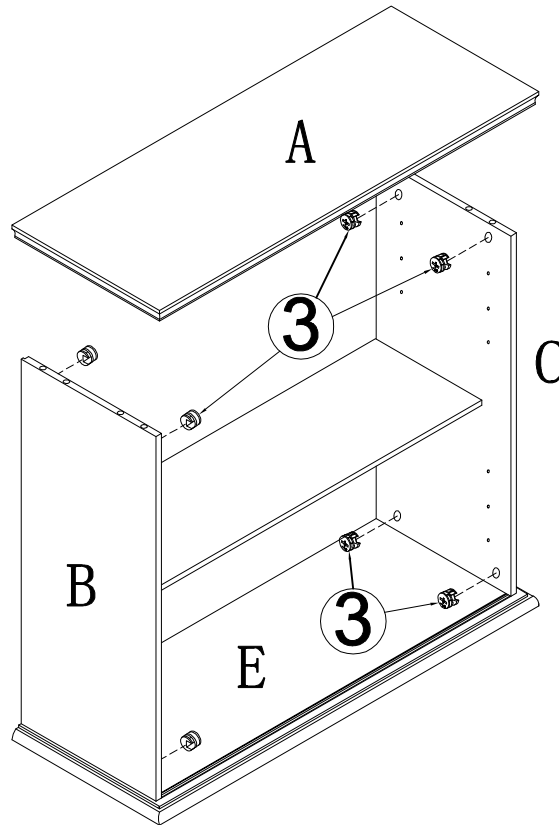

Attach Bottom Panel (E) and Top Panel (A) to Side Panels (B&C), then using Cam-locks (3) to catch inserted Cam-bolts (2) on Top Panel (A) and Bottom Panel (E).

## STEP 5

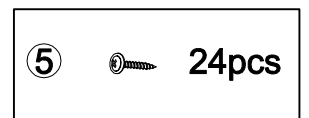
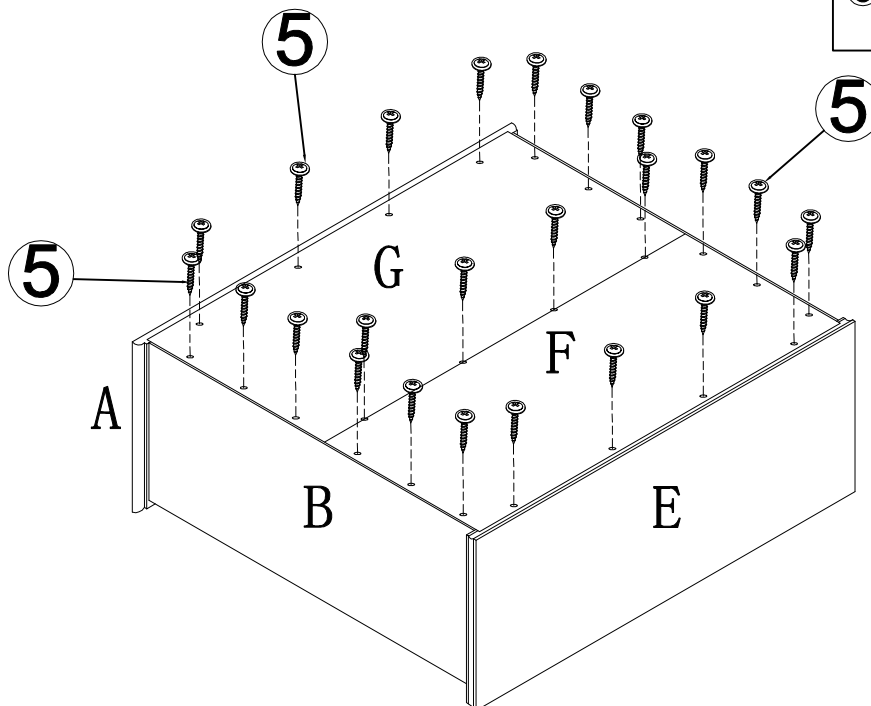

Attach Back Panels (G&F) to the back of this unit using Screws (5).

## STEP 6

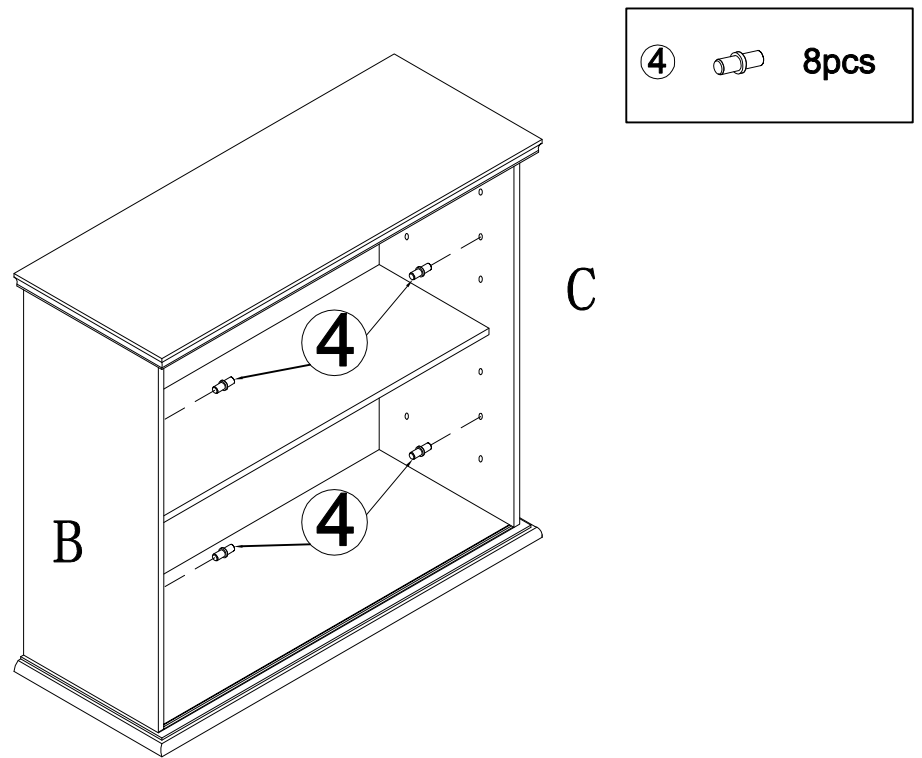

Insert Shelf Supports (4) into the holes on Side Panels (B&C) .

## STEP 7

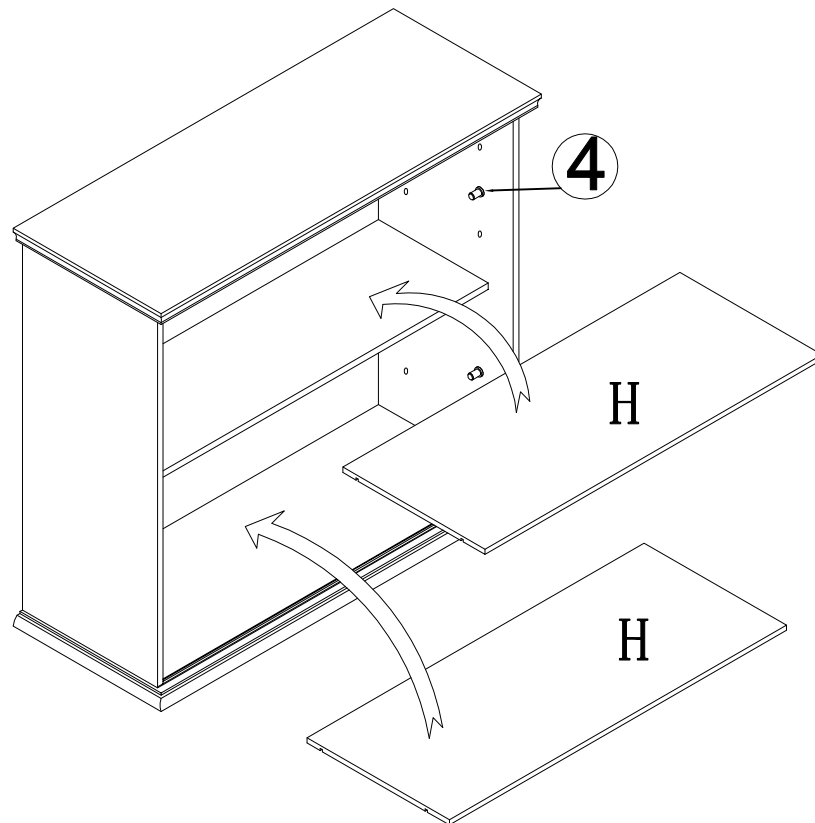

Place Shelves (H) on the top of Shelf Supports (4).

## STEP 8

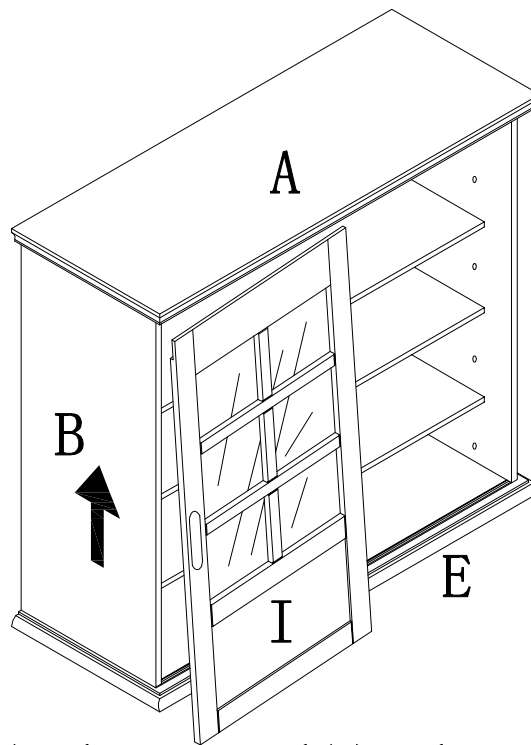

Insert Door (I) to Top Panel (A) and Bottom Panel (E) as above drawing shown.

**NOTE:** Please make sure to slightly incline the door so that the groove on top of the door can catch the glide on top panel.

## STEP 9

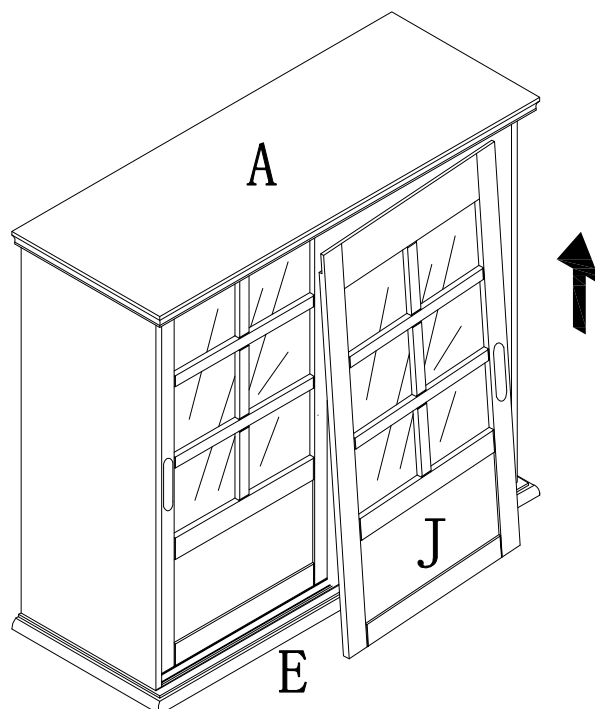

Repeat step 8 to assemble the other Door (J).