

# ASSEMBLY INSTRUCTIONS

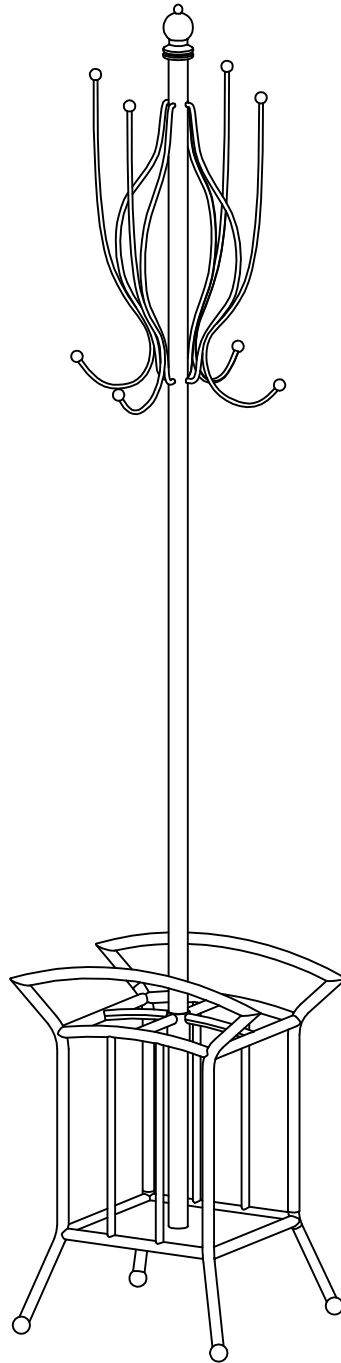





Style # CR1472 Coat Rack



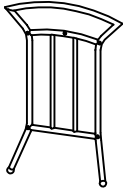

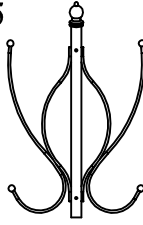

## NOTE TO CUSTOMERS:

- For ease and speed of assembly we recommend that before you commence each step of the assembly that you identify all the parts required to complete that step.
- We recommend that where possible you allow sufficient space to assemble the item as close as possible to the place where it will be once assembled.
- For the protection of your furniture we recommend that the product is placed on protected surfaces during assembly to prevent any damage.
- During assembly do not to over tighten, as this may damage the product.
- Please ensure you retain all the product packaging until the item completely assembled.
- Please periodically check all fittings and re-tighten as necessary.
- It is recommended that this item should be assembled by two adults.

# Part List

<b>A1</b>  Side Frame 2PCS	<b>A2</b>  Bottom Frame 1PC	<b>A3</b>  Top Frame 1PC	<b>A4</b>  Connecting Pole 2PCS	<b>A5</b>  Top Pole 1PC	<b>A6</b>  Hook 2PCS
---	--	---	--	--	---

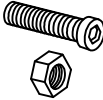
# Hardware List

<b>B1.</b> Quantity of 10  Bolt	<b>B2.</b> Quantity of 1  Bolt	<b>B3.</b> Quantity of 2  Bolt	<b>B4.</b> Quantity of 1  Bolt	 Allen Key and Open Spanner
---	--	--	--	---

## STEP 1

**B1**  **10pcs**

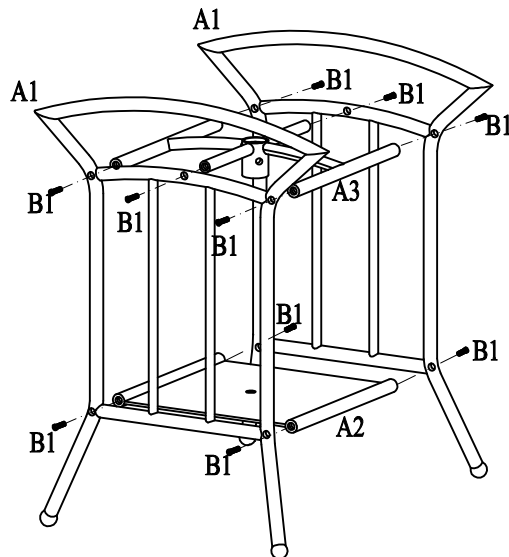

Assemble Side Frames (A1) to Top Frame (A3) and Bottom Frame (A2) using Bolts (B1).  
 Note: Please do not tighten Bolts (B1) until step 4.

## STEP 2

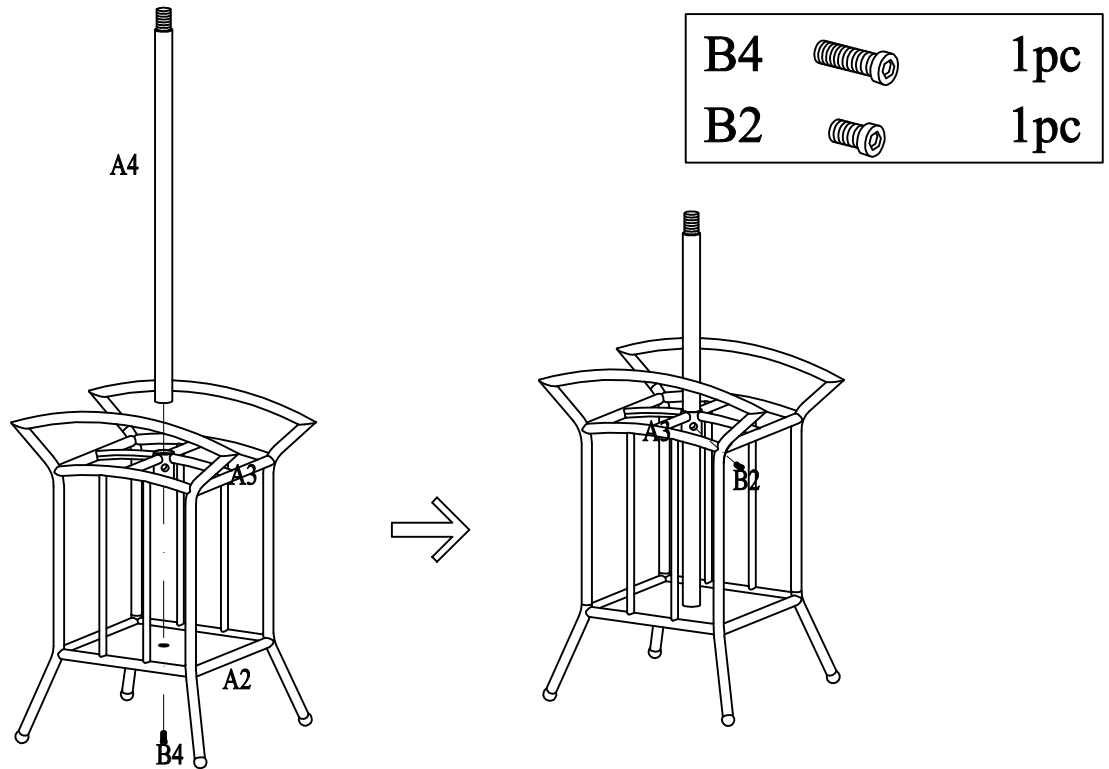

1. Insert Connecting Pole (A4) to Top Frame (A3), then attach it to Bottom Frame (A2) using Bolts (B4).
  2. Attach Connecting Pole (A4) to Top Frame (A3) using Bolt (B2).
- Note: Please do not tighten Bolt (B1&B2) until step 4.

## STEP 3

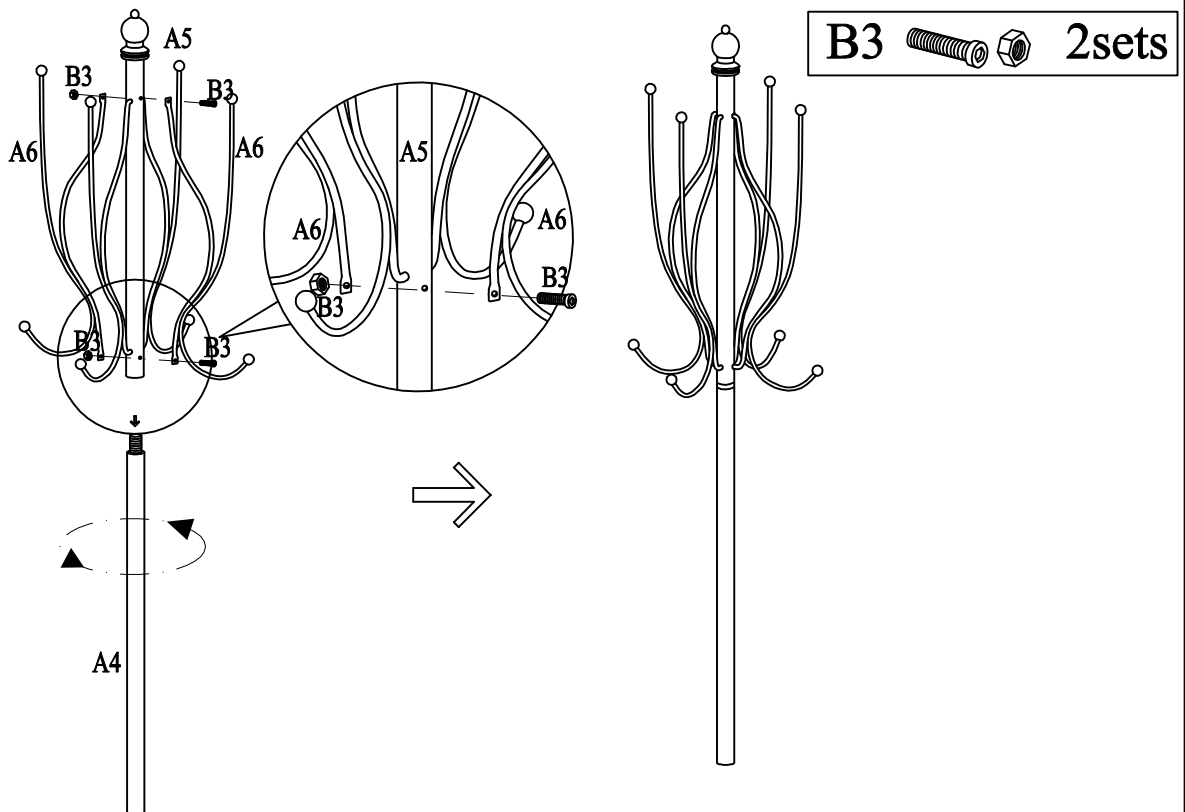

1. Attach Hooks (A6) to Top Pole (A5) using Bolts and Nuts (B3).
2. Tighten Top Pole (A5) to Connecting Pole (A4) as shown above.

# STEP 4

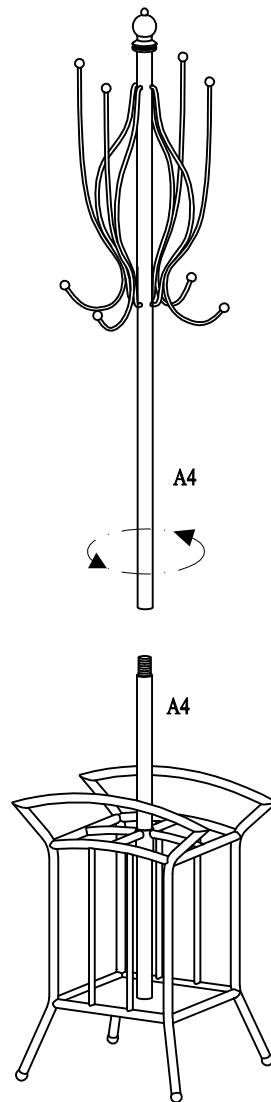

1. Tighten two Connecting Poles (A4) together as shown above .
2. Place this coat rack on the floor to check if it is stable before tightening all bolt.

## APPENDIX: Dimension of Hardwares in this AI.

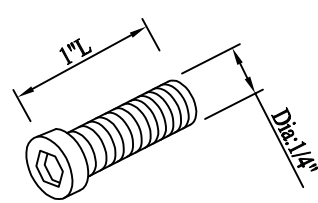
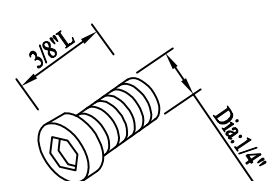
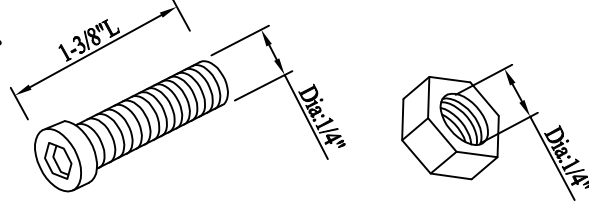
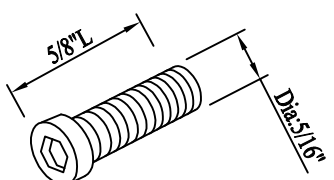
<p><b>B1.</b></p>  <p><b>Bolt</b></p>	<p><b>B2.</b></p>  <p><b>Bolt</b></p>
<p><b>B3.</b></p>  <p><b>Bolt</b></p>	<p><b>B4.</b></p>  <p><b>Bolt</b></p>