

# ASSEMBLY INSTRUCTIONS

## Style#C1288 Console Table

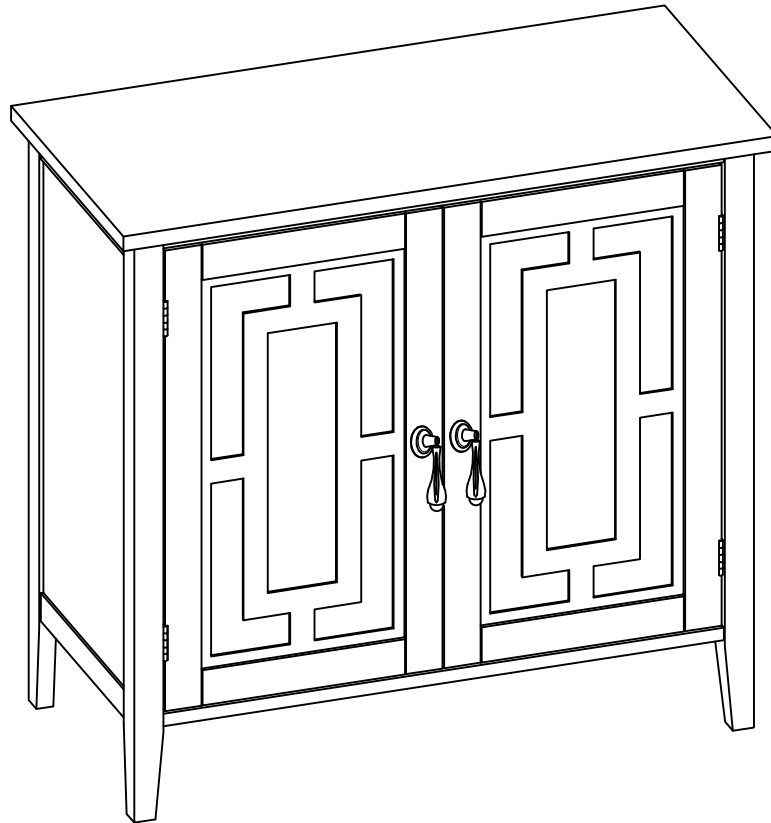

### NOTE TO CUSTOMERS:

- For ease and speed of assembly we recommend that before you commence each step of the assembly that you identify all the parts required to complete that step.
- We recommend that where possible you allow sufficient space to assemble the item as close as possible to the place where it will be once assembled.
- For the protection of your furniture we recommend that the product is placed on protected surfaces during assembly to prevent any damage.
- During assembly do not over tighten, as this may damage the product.
- Please ensure you retain all the product packaging until the item completely assembled.
- Please periodically check all fittings and re-tighten as necessary.
- Please never allow any liquids to remain on your furniture as absorption can cause the wood to warp or finish to de-laminate.
- It is recommended that this item should be assembled by two adults.

## To insert a cam lock: (Please read below instructions before assembling)

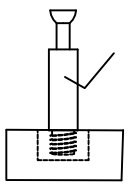
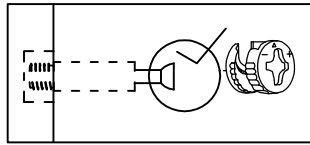

Diagram A



1. Insert cam screw into hole as shown in diagram A .

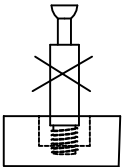
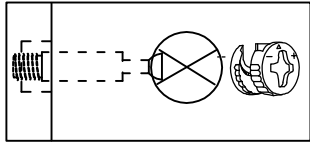

Diagram B



Make sure not to insert the cam screw:  
Too deep as shown in figure B as this will cause the cam screw to be misaligned and unable to interlock properly.

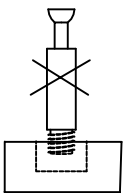
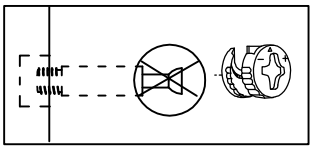
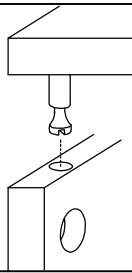

Diagram C



Also avoid inserting the cam screw too close to the surface of the hole as shown in figure C, as this will cause the cam lock to be too loose, and not interlock properly.



2. Connect the panels together.

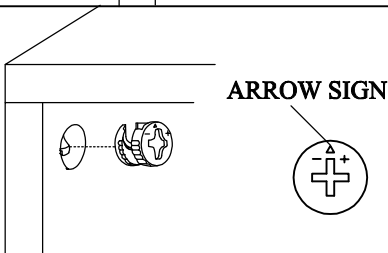

3. When inserting the cam lock make sure the arrow of the cam lock faces the cam screw.

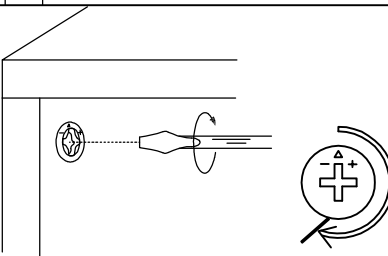

4. To tighten the cam lock turn the cam lock clockwise 90-180 degree or until the arrow is facing opposite the place cam lock was inserted.

**NOTE: DO NOT USE AN AUTOMATIC SCREWDRIVER TO TIGHTEN CAM LOCKS.**

### Tools Required

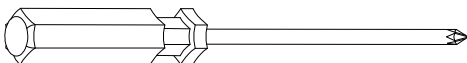





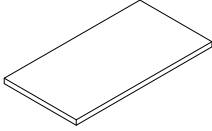
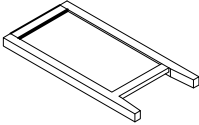
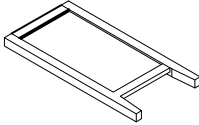
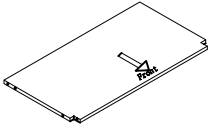
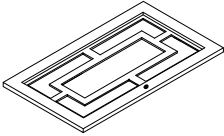
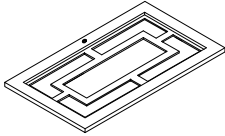
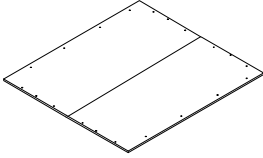
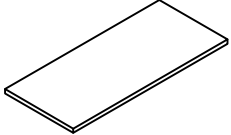

Phillips screwdriver(Not included)

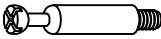
# Part List

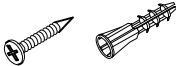
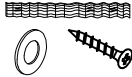

<b>A1</b> Quantity of 1    <b>Top Panel</b>	<b>A2</b> Quantity of 1    <b>Side Panel(Left)</b>	<b>A3</b> Quantity of 1    <b>Side Panel(Right)</b>	<b>A4</b> Quantity of 1    <b>Bottom Panel</b>
<b>A5</b> Quantity of 1    <b>Door(left)</b>	<b>A6</b> Quantity of 1    <b>Door(right)</b>	<b>A7</b> Quantity of 1    <b>Back Panel</b>	<b>A8</b> Quantity of 1    <b>Shelf</b>

# Hardware List

<b>B1</b> Quantity of 8    <b>Wood Dowel</b>	<b>B2</b> Quantity of 8    <b>Cam-Bolt</b>	<b>B3</b> Quantity of 8    <b>Cam- Lock</b>	<b>B4</b> Quantity of 8    <b>Screw</b>
<b>B5</b> Quantity of 2    <b>Door Handle</b>	<b>B6</b> Quantity of 20    <b>Screw</b>	<b>B7</b> Quantity of 4    <b>Shelf Support</b>	<b>B8</b> Quantity of 1    <b>Magnet</b>
<b>B9</b> Quantity of 1    <b>Wall Anchor with Screw</b>	<b>B10</b> Quantity of 1    <b>Anti-tip Kit</b>		

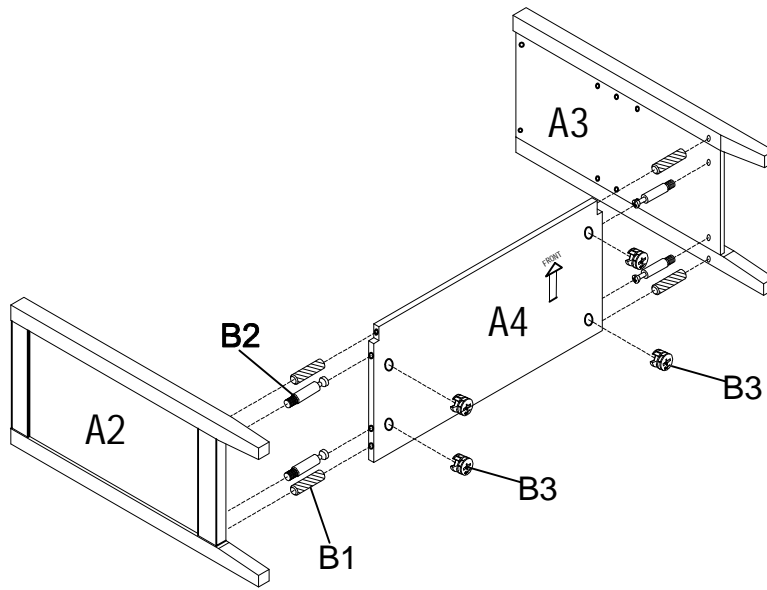
# STEP 1





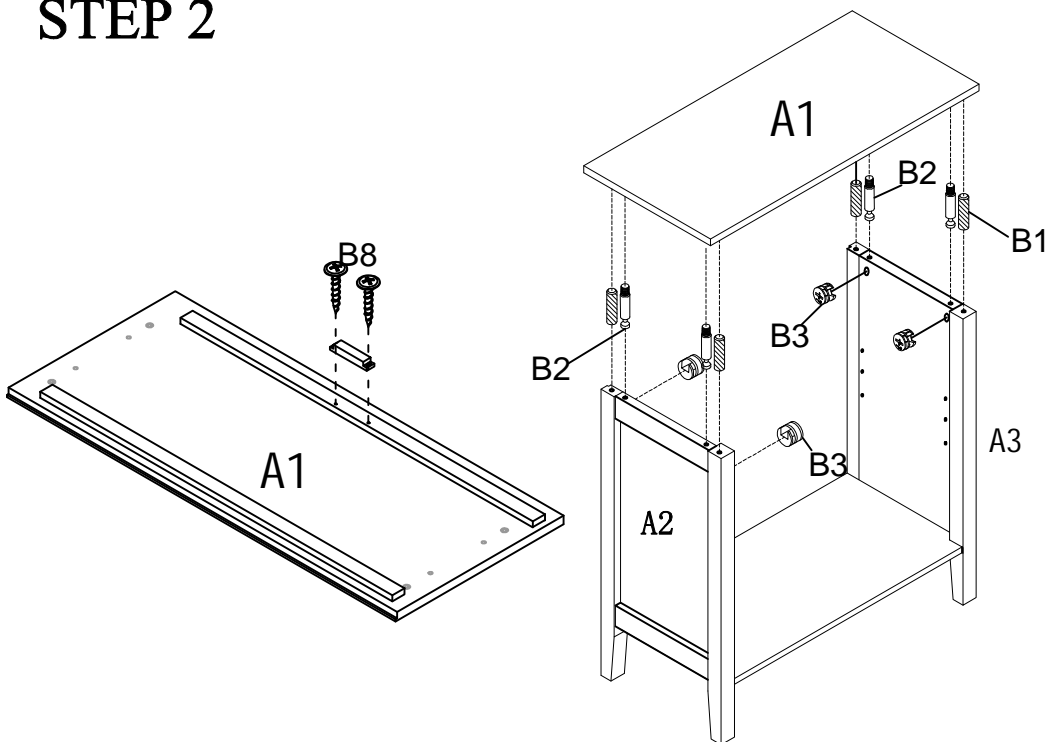

B1		4pcs
B2		4pcs
B3		4pcs

Assemble Side Panels A2 & A3 to Bottom Panel A4 using Wood dowels B1, Cam-Bolts B2 and Cam-locks B3.

# STEP 2



B1		4pcs
B2		4pcs
B3		4pcs
B8		1set

- 1). Attach Magnet B8 to the bottom of Top Panel A1 using included screws.
- 2). Assemble Top Panel A1 to Side Panels A2 & A3 using Wood dowels B1, Cam-Bolts B2 and Cam-locks B3.

## STEP 3

B6  20pcs

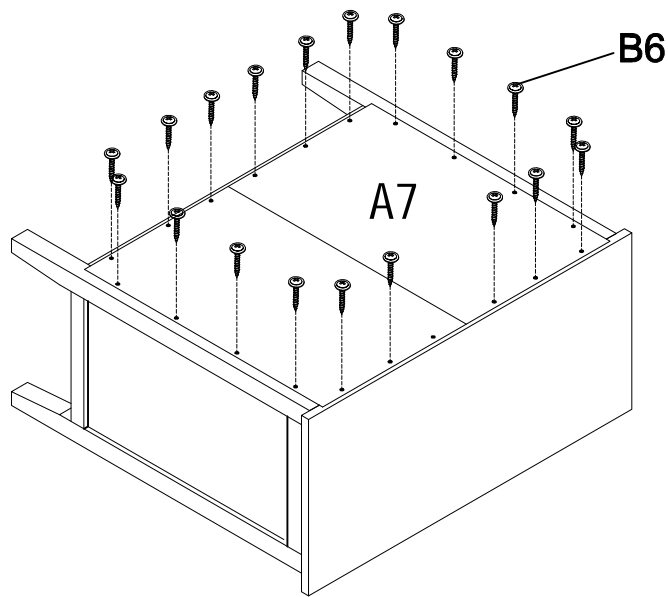

Attach Back Panel A7 to Side Panels A2 & A3 and Top Panel A1 using Screws B6.

## STEP 4

B4  8pcs

B5  2sets

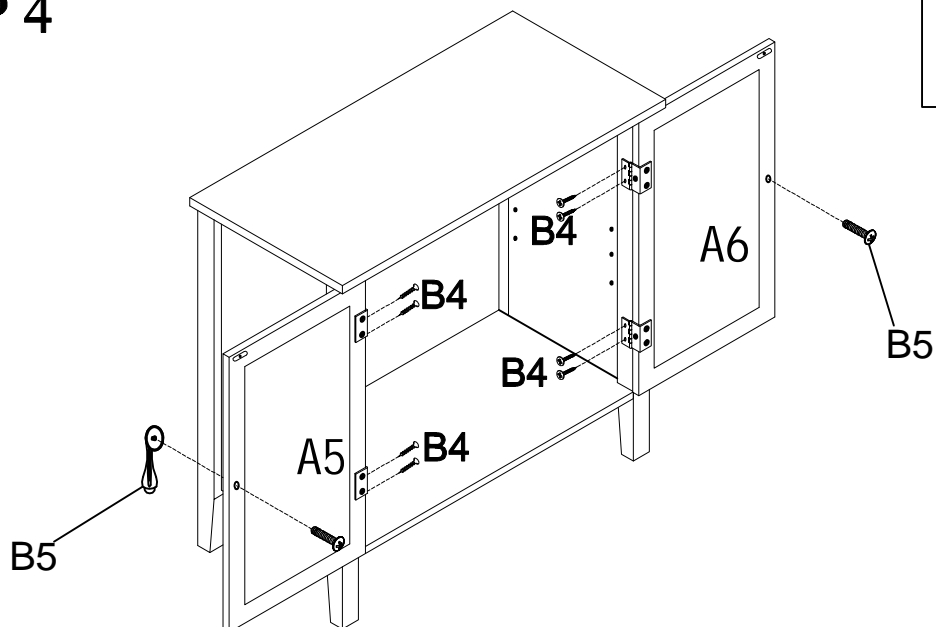

- 1). Attach Handles B5 to Doors A5 & A6 by included bolts.
- 2). Attach Doors A5 & A6 to Side Panels A2 and A3 using Screws B4.

# STEP 5

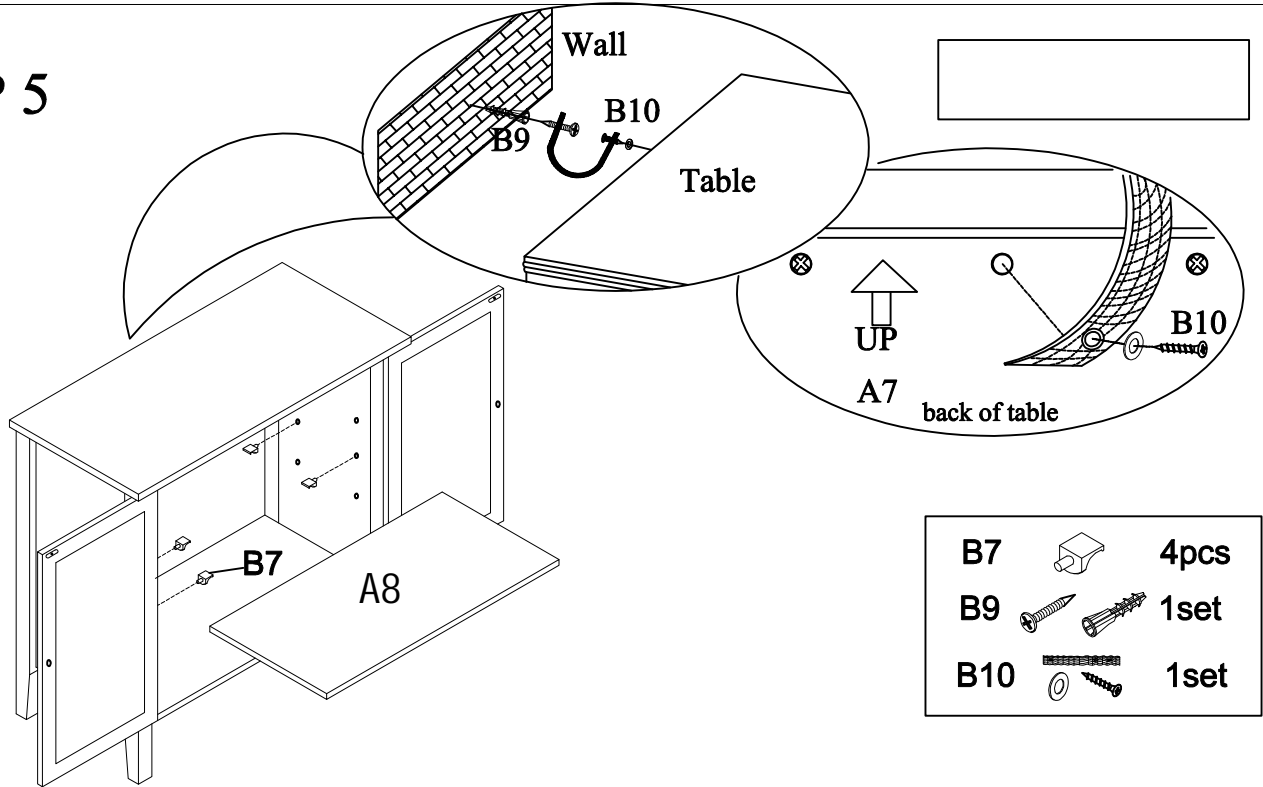

- 1). Insert Shelf Supports B7 into the holes on Side Panels A2 & A3, then put Shelf A8 onto the Shelf Supports B7, please note holes are pre-drilled.
- 2). For your safety, please attach this unit to the wall by Anti-tip Kit B10 and Anchor with Screw B9.

## APPENDIX: Dimension of Hardwares in this AI.

<p>B1</p> <p>Quantity of 8</p> <p>Wood Dowel</p>	<p>B2</p> <p>Quantity of 8</p> <p>Cam-Bolt</p>	<p>B3</p> <p>Quantity of 8</p> <p>Cam-Lock</p>	<p>B4</p> <p>Quantity of 4</p> <p>Screw</p>
<p>B5</p> <p>Quantity of 2</p> <p>Door Handle</p>	<p>B6</p> <p>Quantity of 20</p> <p>Screw</p>	<p>B7</p> <p>Quantity of 4</p> <p>Shelf Support</p>	