

ASSEMBLY INSTRUCTIONS

Style # C1244 & C1299 Console Table

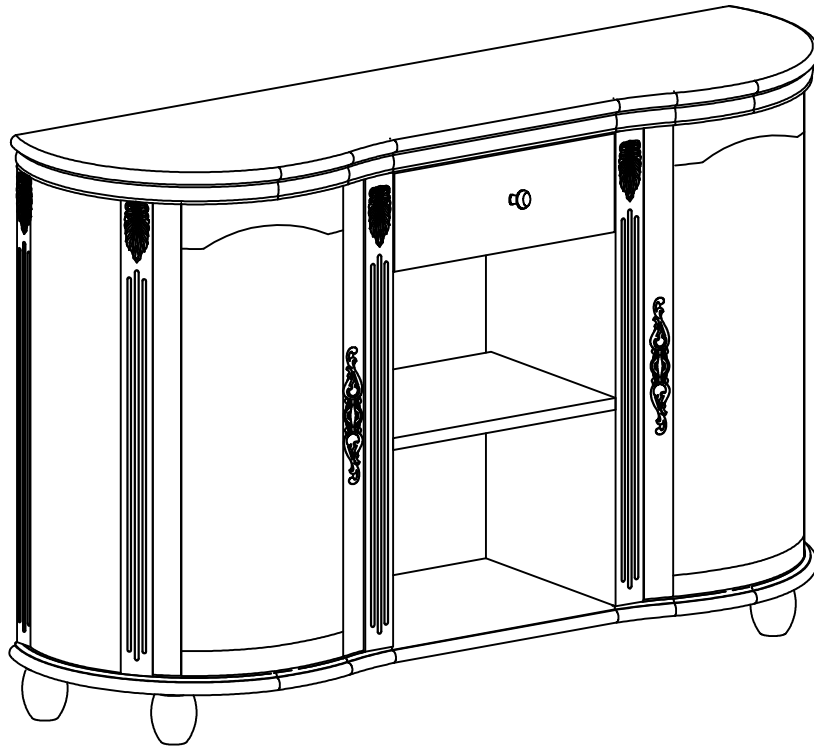

NOTE TO CUSTOMERS:

- For ease and speed of assembly we recommend that before you commence each step of the assembly that you identify all the parts required to complete that step.
- We recommend that where possible you allow sufficient space to assemble the item as close as possible to the place where it will be once assembled.
- For the protection of your furniture we recommend that the product is placed on protected surfaces during assembly to prevent any damage.
- During assembly do not over tighten, as this may damage the product.
- Please ensure you retain all the product packaging until the item completely assembled.
- Please periodically check all fittings and re-tighten as necessary.
- Never allow any liquids to remain on your furniture as absorption can cause the wood to warp or the finish to de-laminate.
- It is recommended that this item should be assembled by two adults.

To insert a cam lock: (Please read below instructions before assembling)







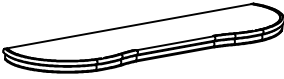

	<p>Diagram A</p>	<p>1. Insert cam screw into hole as shown in diagram A .</p>
	<p>Diagram B</p>	<p>Make sure not to insert the cam screw: Too deep as shown in figure B as this will cause the cam screw to be misaligned and unable to interlock properly.</p>
	<p>Diagram C</p>	<p>Also avoid inserting the cam screw too close to the surface of the hole as shown in figure C, as this will cause the cam lock to be too loose, and not interlock properly.</p>

	<p>2. Connect the panels together.</p>
	<p>3. When inserting the cam lock make sure the arrow of the cam lock faces the cam screw.</p>
	<p>4. To tighten the cam lock turn the cam lock clockwise 90-180 degree or until the arrow is facing opposite the place cam lock was inserted.</p> <p>NOTE: DO NOT USE AN AUTOMATIC SCREWDRIVER TO TIGHTEN CAM LOCKS.</p>

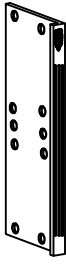

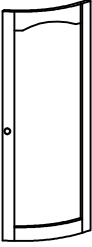
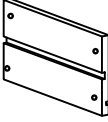
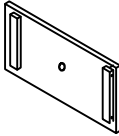

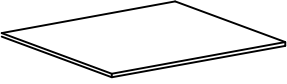
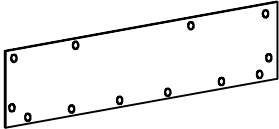
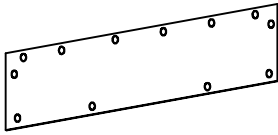
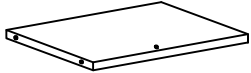
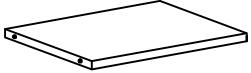

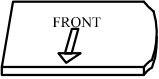

Note:

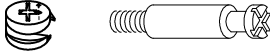
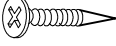
- Read these instructions carefully before assembling.
- Tools required : Phillips screwdriver, flat screwdriver.
- Find a clean, smooth area on which to work , such as a carpet, in order to avoid scratching the wood surfaces.
- Wait to dispose of the packing material until assembly is complete and all parts and hardware are accounted for.
- Two or more people might be required for assembly.

Part List

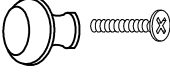
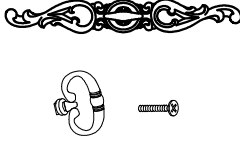
<p>A1. Quantity of 1</p>  <p>Top Panel</p>	<p>A2. Quantity of 1</p>  <p>Bottom Panel</p>	<p>A3(L&R). Quantity of 2</p>  <p>Divider</p>	<p>A4(L&R). Quantity of 2</p>  <p>Side Panel</p>
<p>A5(L&R). Quantity of 2</p>  <p>Door Panel</p>	<p>A6. Quantity of 2</p>  <p>Drawer Side Panel</p>	<p>A7. Quantity of 1</p>  <p>Drawer Front Panel</p>	<p>A8. Quantity of 1</p>  <p>Drawer Back Panel</p>
<p>A9. Quantity of 1</p>  <p>Drawer Bottom Panel</p>	<p>A10. Quantity of 1</p>  <p>Back Panel</p>	<p>A11. Quantity of 1</p>  <p>Back Panel</p>	<p>A12. Quantity of 1</p>  <p>Shelf</p>
<p>A13. Quantity of 1</p>  <p>Shelf</p>	<p>A14. Quantity of 4</p>  <p>Leg</p>	<p>A15. Quantity of 2</p>  <p>Side Adjustable Shelf</p>	

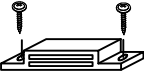
Hardware List

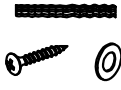
<p>B1</p> <p style="text-align: center;">Quantity of 24</p>  <p>Camlock</p>	<p>B2</p> <p style="text-align: center;">Quantity of 8</p>  <p>Screw</p>	<p>B3</p> <p style="text-align: center;">Quantity of 24</p>  <p>Screw</p>	<p>B4</p> <p style="text-align: center;">Quantity of 12</p>  <p>Screw</p>
<p>B5</p> <p style="text-align: center;">Quantity of 1</p>  <p>Stopper</p>	<p>B6</p> <p style="text-align: center;">Quantity of 1</p>  <p>Drawer Knob</p>	<p>B7</p> <p style="text-align: center;">Quantity of 2</p>  <p>Door Knob</p>	<p>B8</p> <p style="text-align: center;">Quantity of 8</p>  <p>Shelf Support</p>
<p>B9</p> <p style="text-align: center;">Quantity of 2</p>  <p>Magnet</p>	<p>B10</p> <p style="text-align: center;">Quantity of 1</p>  <p>Anchor with Screw</p>	<p>B11</p> <p style="text-align: center;">Quantity of 1</p>  <p>Anti-tip kit</p>	



WARNING:

**Serious or fatal crushing injuries can occur from furniture tip-over.
To help prevent tip-over:**

- Place heaviest item in the lowest drawers.
- Unless specifically designed to accommodate, do not set TVs or other heavy objects on top of this product.
- Never allow children to climb or hang on drawers, doors or shelves.
- Never open more than one drawer at a time.(OR)
- Do not defeat or remove the drawer interlock system.

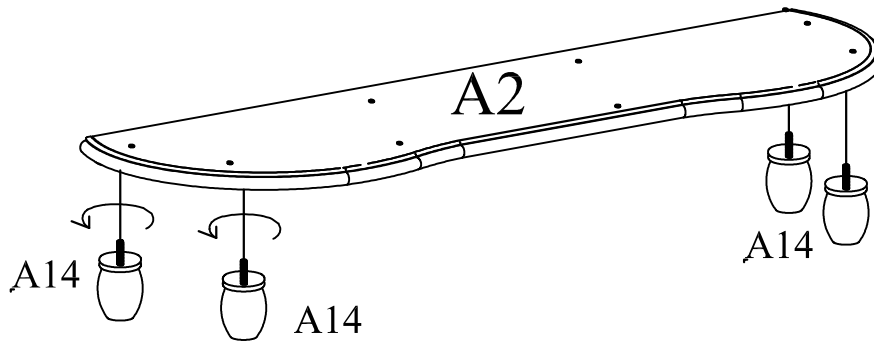

Use of tip-over restraints may only reduce, but not eliminate the risk of tip-over.

STEP 1

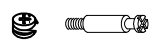

Attach Legs A14 to the bottom of Bottom Panel A2.

STEP 2

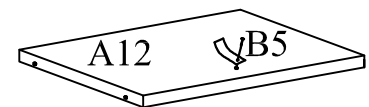
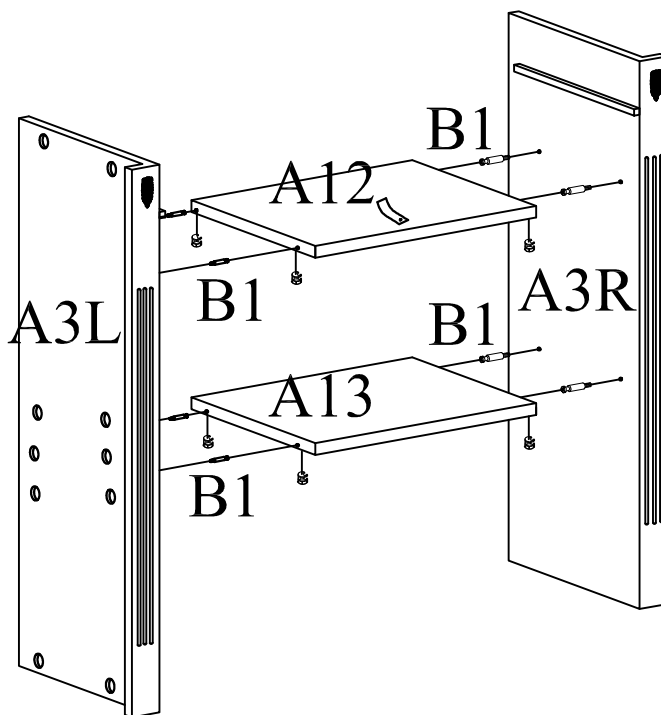

B1:		8sets
B5:		1set

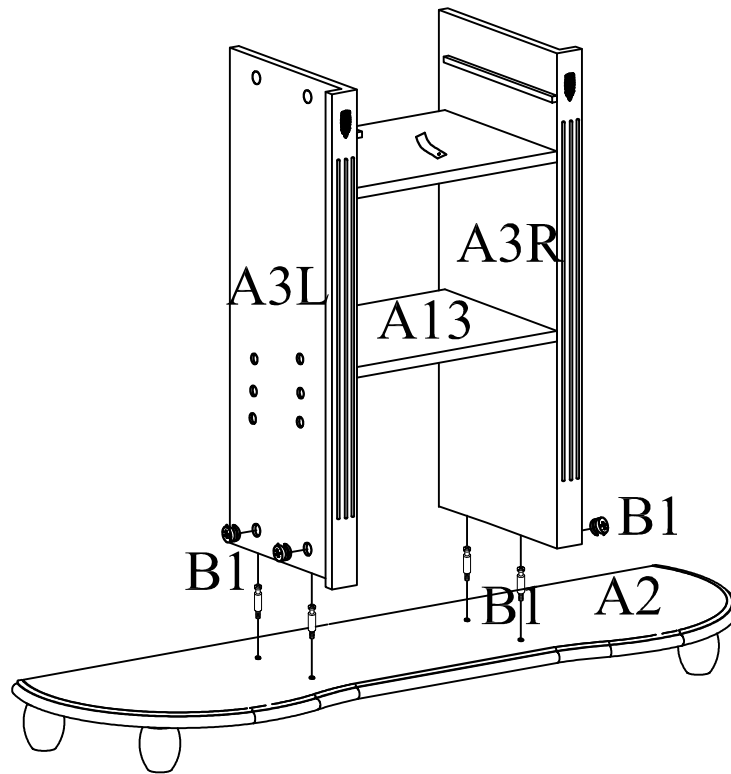

1. Attach Stopper B5 to Shelf A12 using included Screw.
2. Assemble Shelves A12&A13 to Dividers A3(L&R) using Camlocks B1.

STEP 3





B1:   4sets

Assemble Dividers A3(L&R) to Bottom Panel A2 using Camlocks B1.

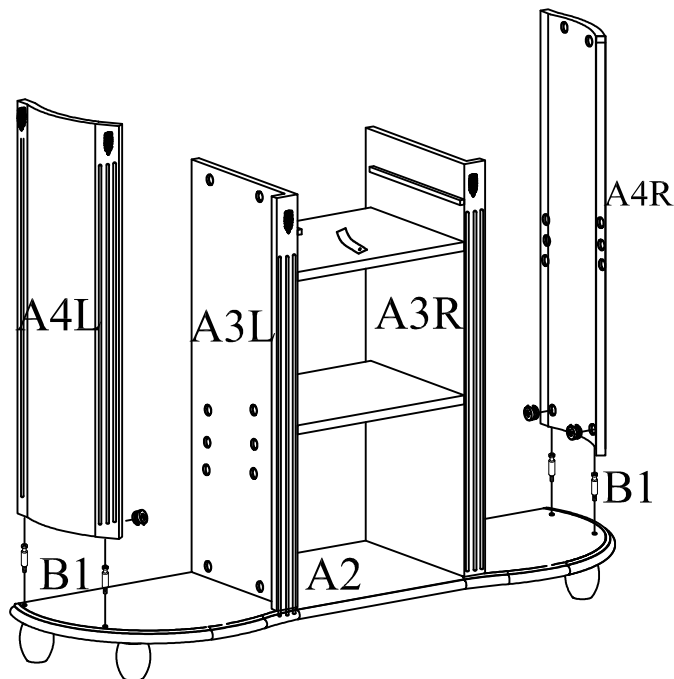

STEP 4



B1:   4sets

Assemble Side Panels A4(L&R) to Bottom Panel A2 using Camlocks B1.

STEP 5

B1:		8sets
B9:		2sets

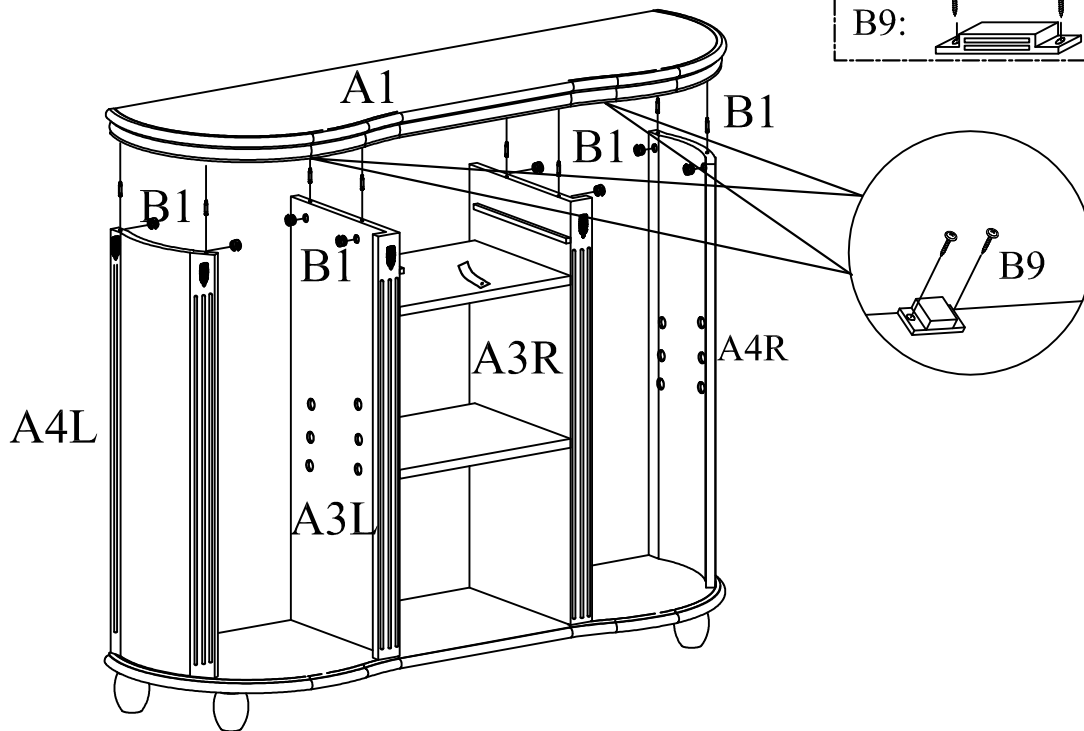

1. Attach Magnets B9 to the bottom of Top Panel A1 using included Screws.
2. Assemble Top Panel A1 to Side Panels A4(L&R) and Dividers A3(L&R) using Camlocks B1.

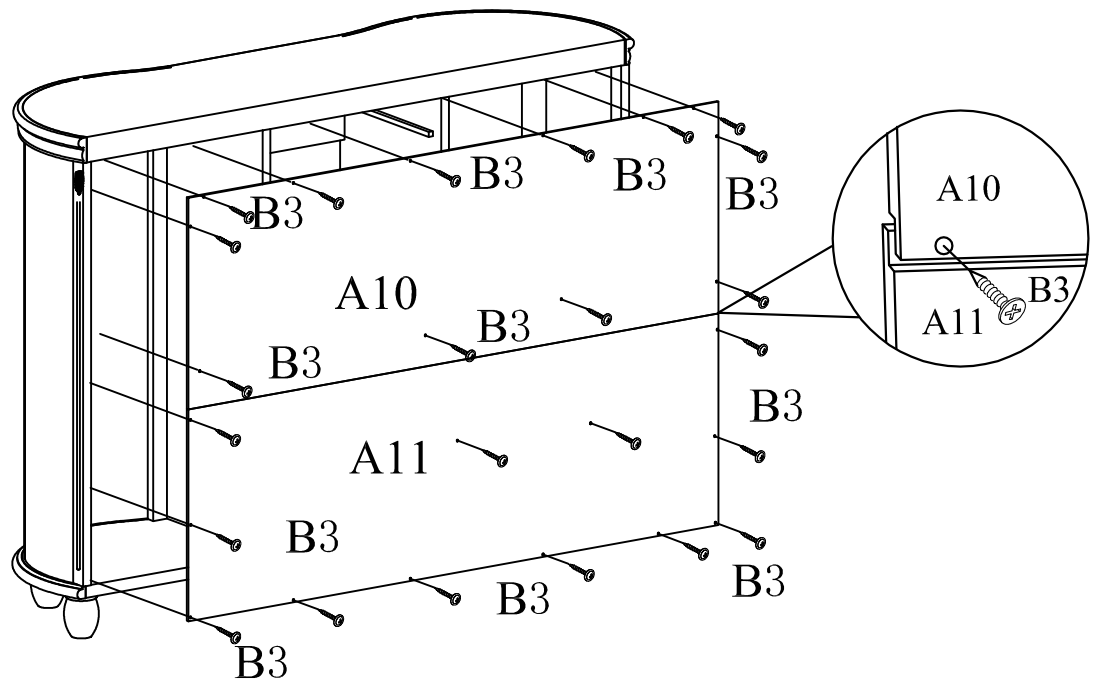

STEP 6

B3:		24pcs
-----	---	-------



Attach Back Panels A10 and A11 to the back of this unit using Screws B3.

STEP 7

B2:		8pcs
B6:		1set

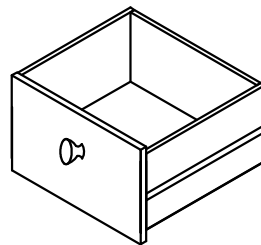
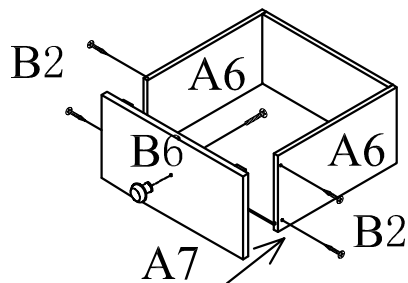
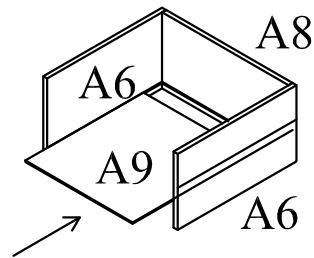
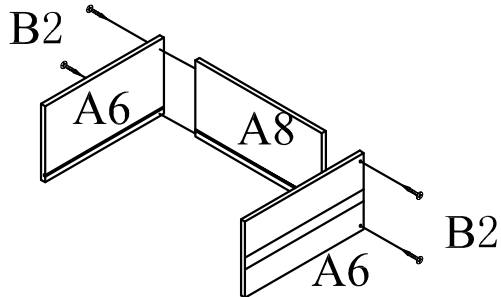

1. Assemble Drawer Side Panels A6 to Drawer Back Panel A8 using Screws B2.
2. Insert Drawer Bottom Panel A9 into the grooves on Drawer Side Panels A6 and Drawer Back Panel A8.
3. Attach Drawer Knob B6 to Drawer Front Panel A7 using included Bolt.
4. Assemble Drawer Front Panel A7 to Drawer Side Panels A6 using Screws B2.

STEP 8

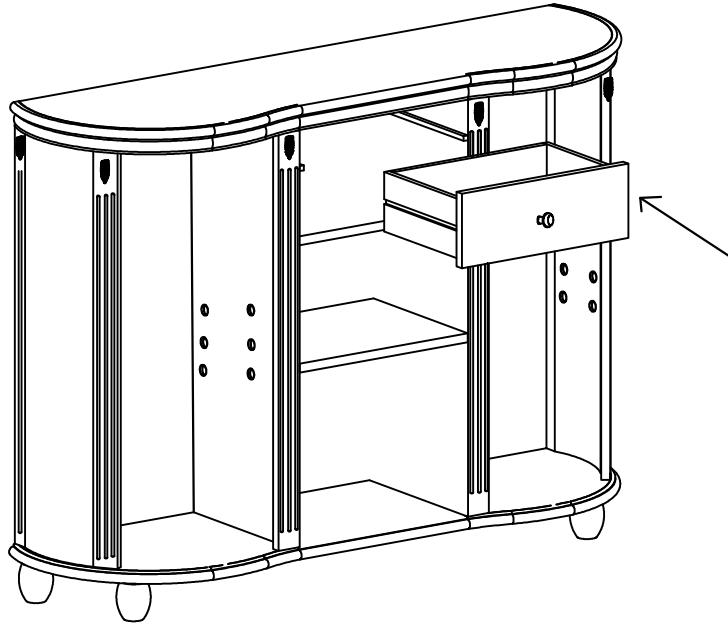



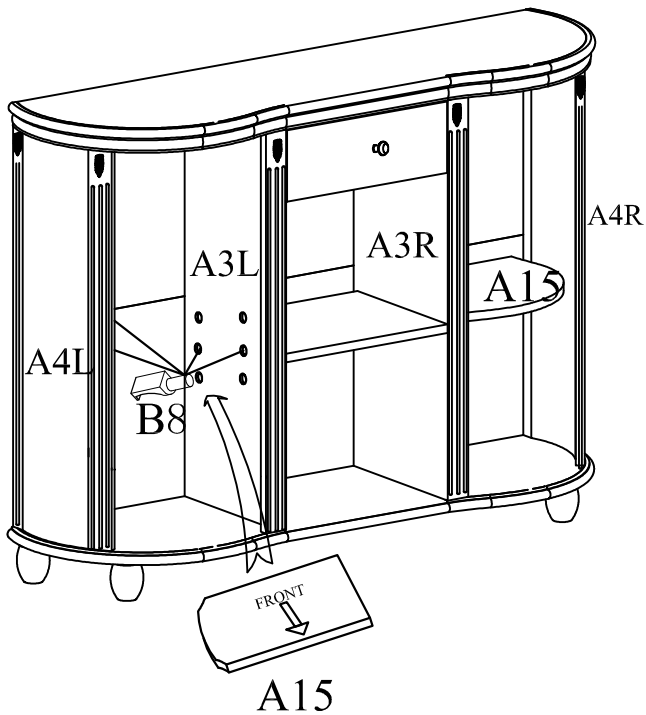

STEP 9

B8:  8pcs



1. Insert Shelf Supports B8 into the holes on Side Panels A4(L&R) and Dividers A3(L&R).
2. Place Shelves A15 on the top of Shelf Supports B8.

STEP 10

B7:			2sets
B4:			12pcs

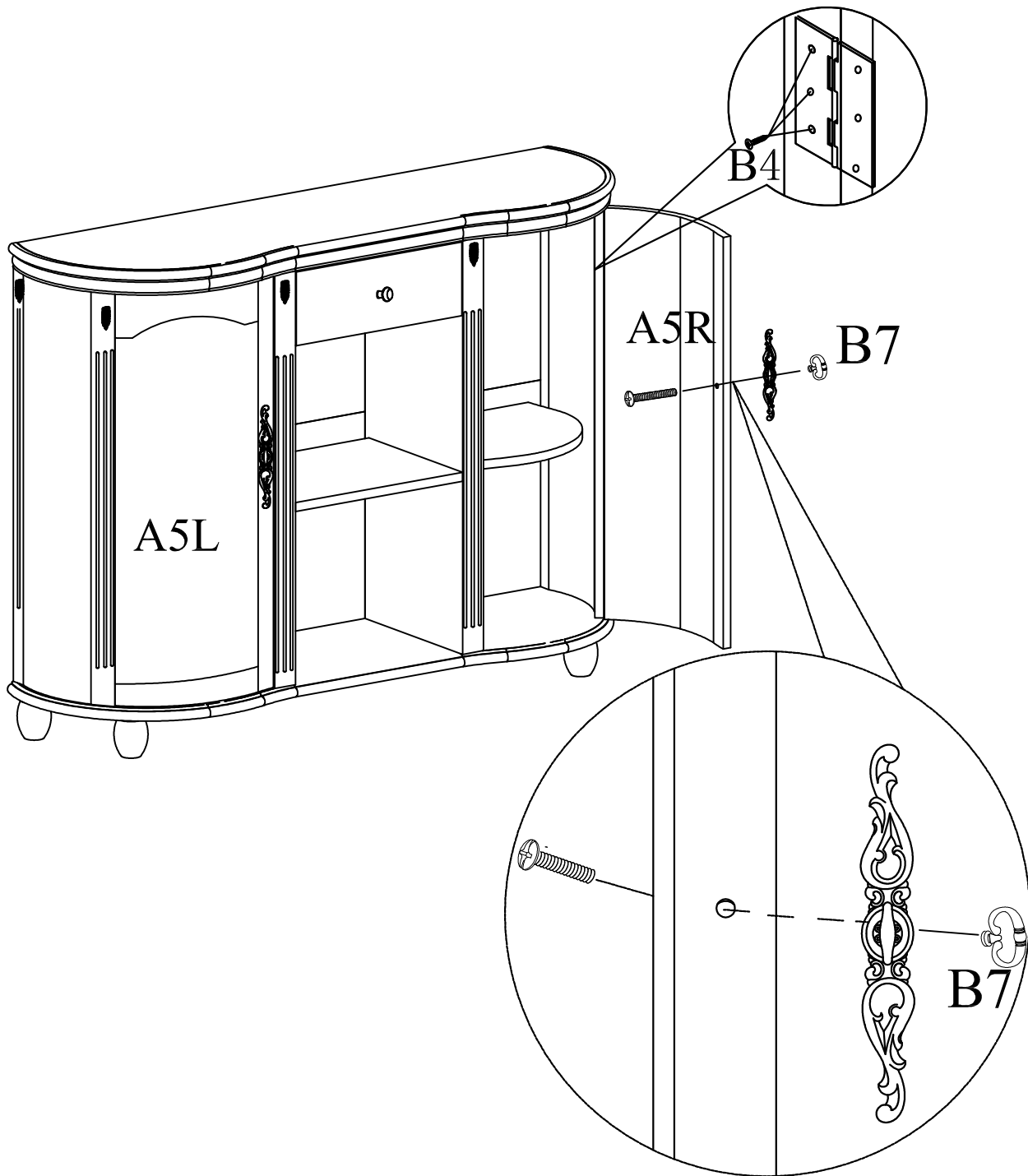

1. Attach Door Knobs B7 to Door Panels A5(L&R) using included Bolts as above drawing shown.
2. Assemble Door Panels A5(L&R) to Side Panels A4(L&R) using Screws B4 as above drawing shown.

STEP 11

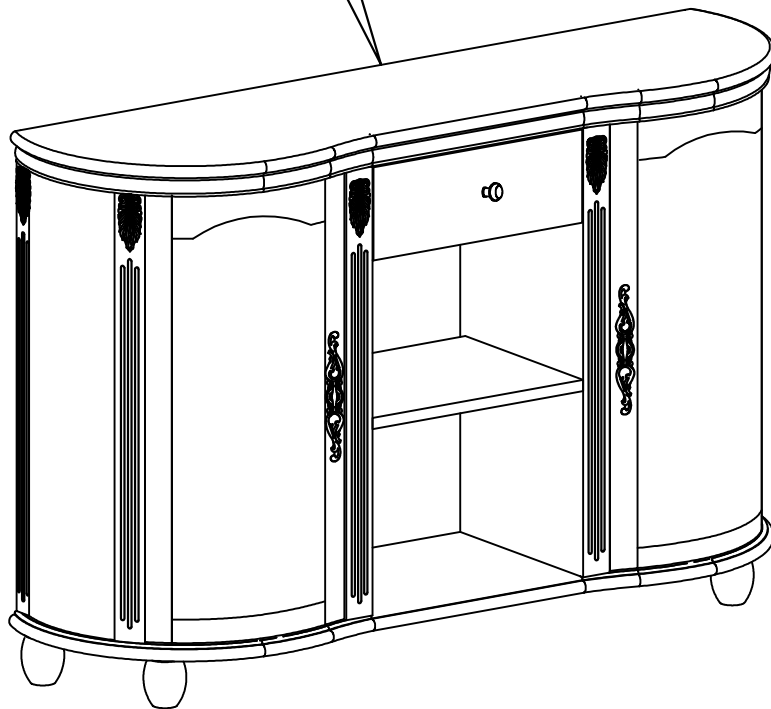
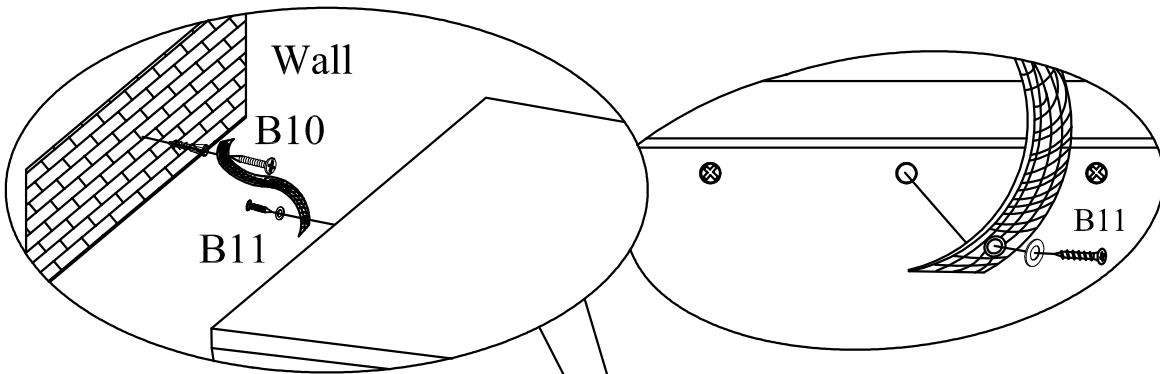
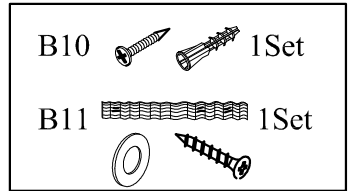

For your safety, please attached this unit to the wall by Anchor with screws B10 and Anti-tip kit B11.

APPENDIX: Dimension of Hardwares in this AI.

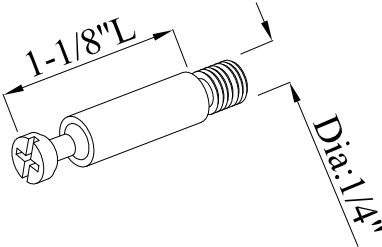
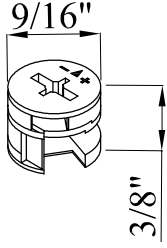
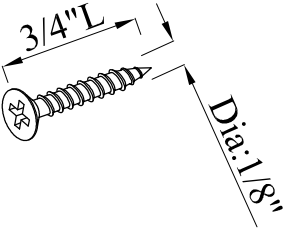
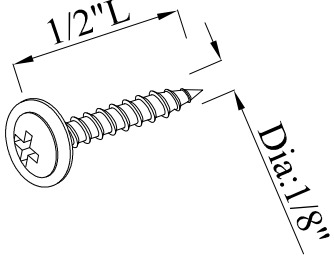
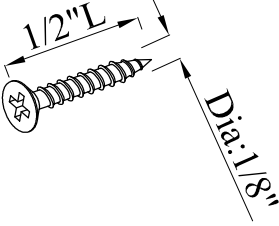
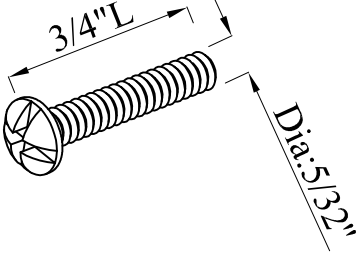
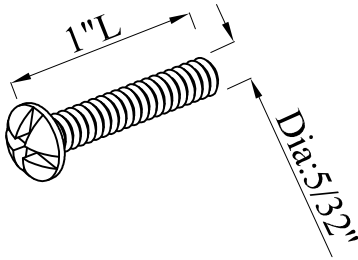
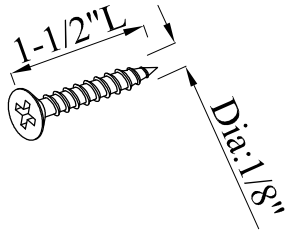
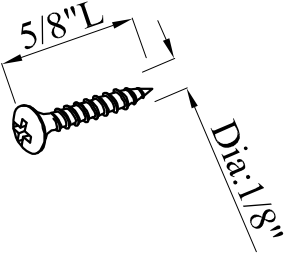
<p>B1.</p>  <p>Cam-bolt</p>	<p>B1.</p>  <p>Cam-nut</p>	<p>B2.</p>  <p>Screw</p>
<p>B3&B9.</p>  <p>Screw</p>	<p>B4&B5.</p>  <p>Screw</p>	<p>B6.</p>  <p>Bolt for Handle</p>
<p>B7.</p>  <p>Bolt for Handle</p>	<p>B10</p>  <p>Screw</p>	<p>B11</p>  <p>Screw</p>