

ASSEMBLY INSTRUCTIONS

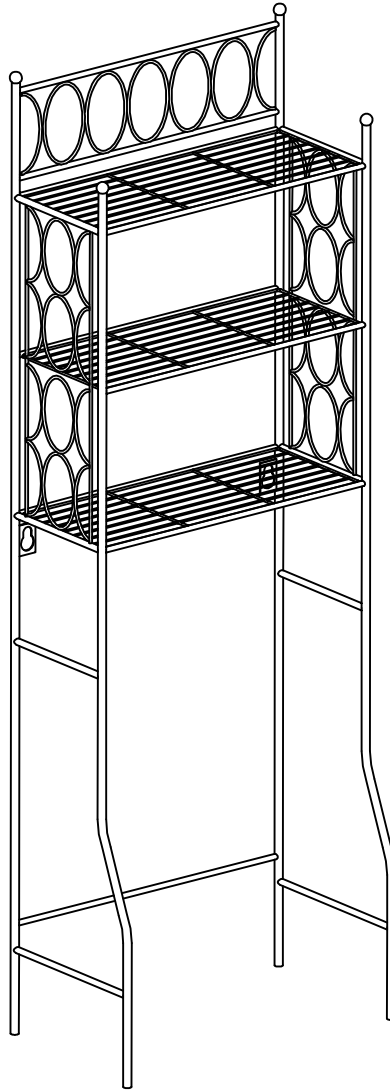



Style # BM1127 Etagere Bathroom Rack





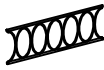
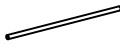

NOTE TO CUSTOMERS:

- For ease and speed of assembly we recommend that before you commence each step of the assembly that you identify all the parts required to complete that step.
- We recommend that where possible you allow sufficient space to assemble the item as close as possible to the place where it will be once assembled.
- For the protection of your furniture we recommend that the product is placed on protected surfaces during assembly to prevent any damage.
- During assembly do not over tighten, as this may damage the product.
- Please ensure you retain all the product packaging until the item completely assembled.
- Please periodically check all fittings and re-tighten as necessary.
- It is recommended that this item should be assembled by two adults.

Part List

<p>A1</p> <p>Quantity of 1</p>  <p>Left Leg</p>	<p>A2</p> <p>Quantity of 1</p>  <p>Right Leg</p>	<p>A3</p> <p>Quantity of 2</p>  <p>Left Side Frame</p>	<p>A4</p> <p>Quantity of 3</p>  <p>Right Side Frame</p>
<p>A5</p> <p>Quantity of 3</p>  <p>Shelf</p>	<p>A6</p> <p>Quantity of 1</p>  <p>Back Apron</p>	<p>A7</p> <p>Quantity of 1</p>  <p>Connect Bar</p>	

Hardware List

<p>a.</p> <p>Quantity of 18</p>  <p>Bolt</p>	<p>b.</p> <p>Quantity of 2</p>  <p>Screw</p>	<p>c.</p> <p>Quantity of 2</p>  <p>Anchor</p>	<p>d.</p> <p>Quantity of 1</p>  <p>Allen Key</p>
<p>(NOT INCLUDED)</p> 			

APPENDIX: Dimension of Hardwares in this AI.

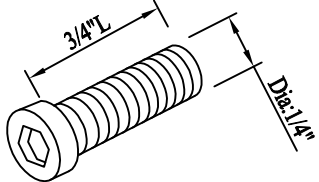
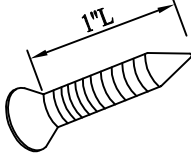
<p>a.</p>  <p>Bolt</p>	<p>b.</p>  <p>Screw</p>
---	--

STEP 1

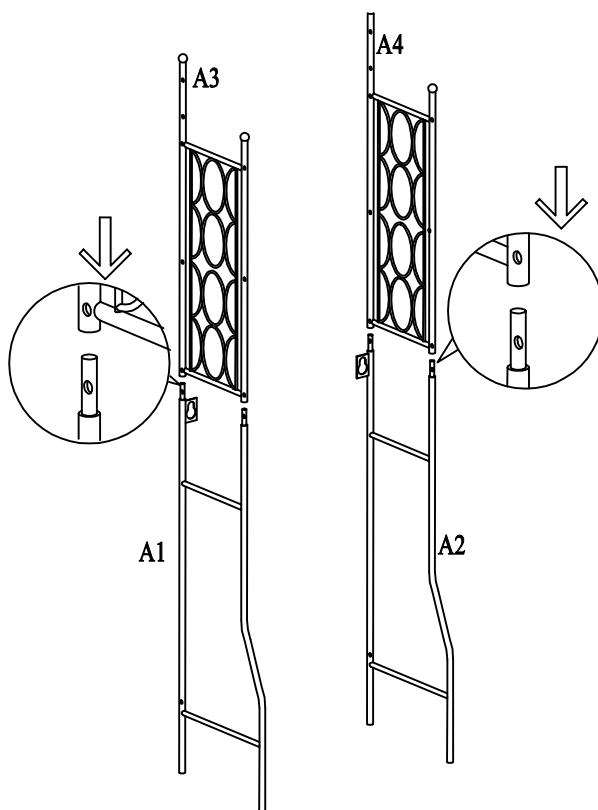

Insert Left Side Frame (A3) to Left Leg (A1) and Right Side Frame (A4) to Right Leg (A2) as shown above.

STEP 2

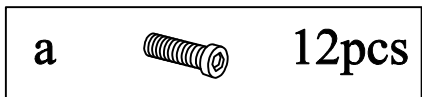
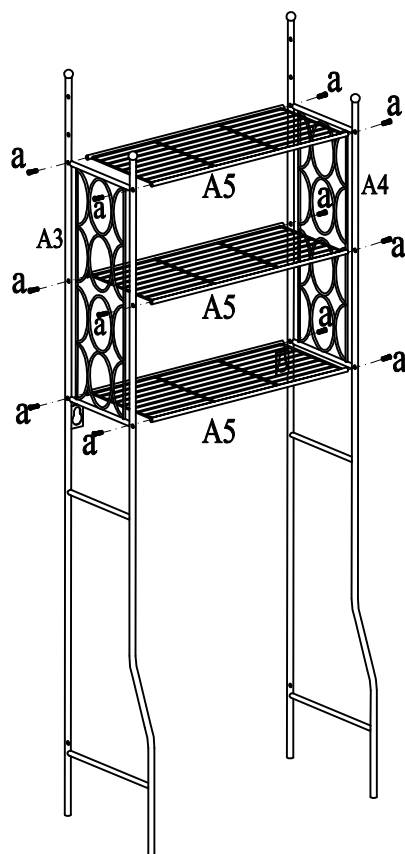

Attach Shelves (A5) to Side Frames (A3&A4) using Bolts (a).
NOTE: Please do not tighten Bolts (a) until step 4.

STEP 3

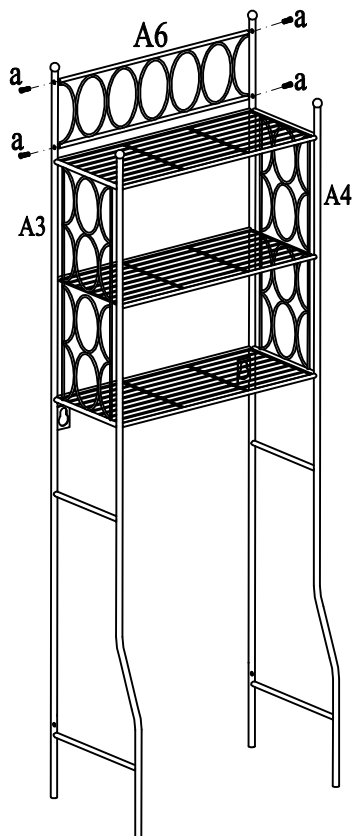

a  4pcs

Attach Back Apron (A6) to Side Frames (A3&A4) using Bolts (a).
NOTE: Please do not tighten Bolts (a) until step 4.

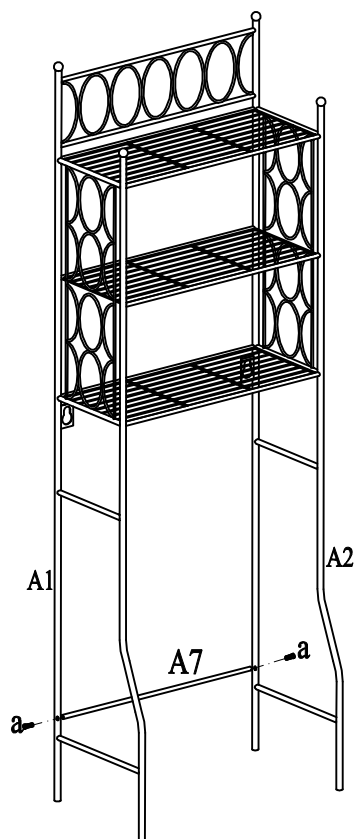

STEP 4



a  2pcs

Attach Back Connect Bar (A7) to Legs (A1&A2) using Bolts (a).
Place the rack on the floor and check if it is stable before tightening all bolts.

STEP 5

b		2pcs
c		2pcs

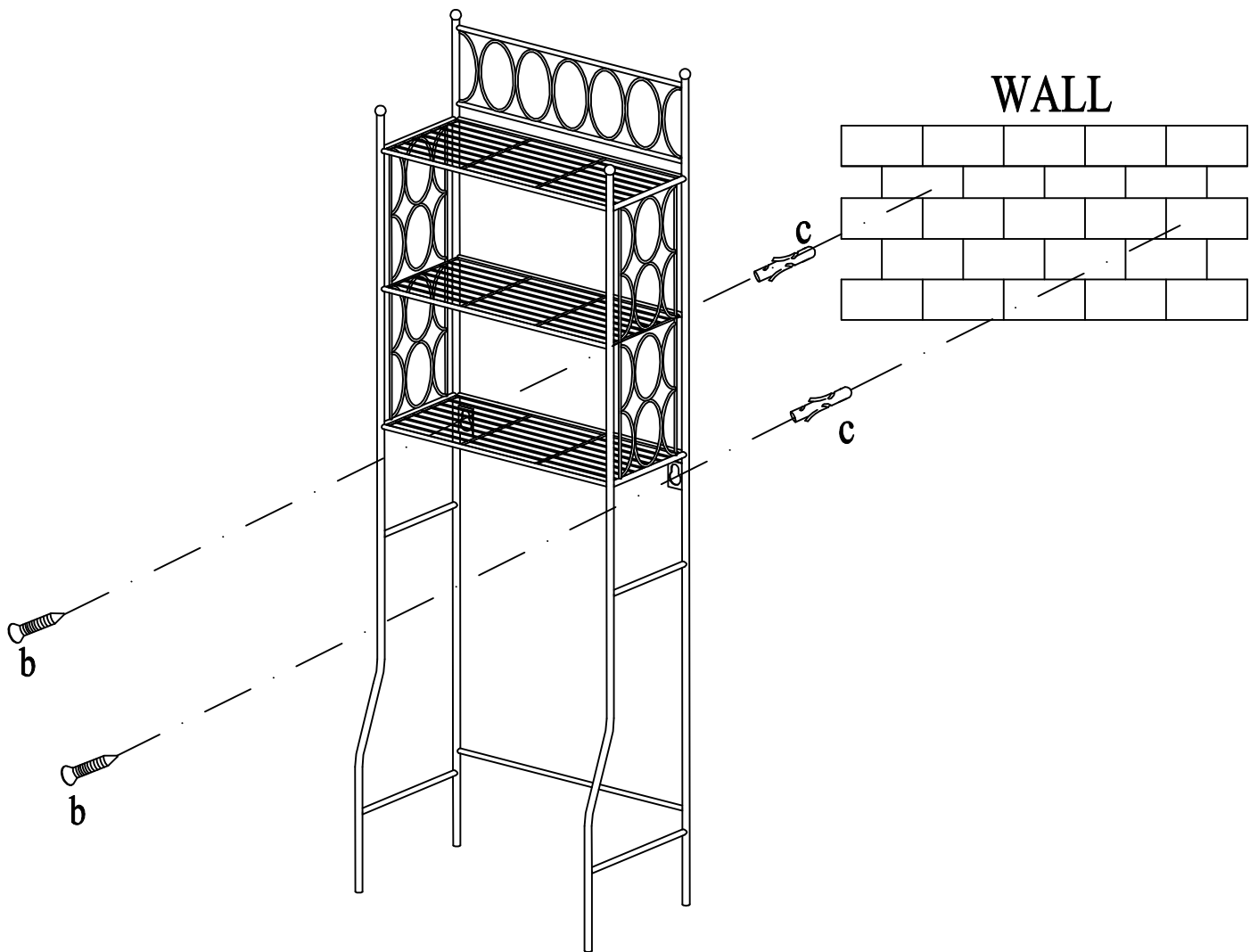

For your safty please Attach this item to the wall using Anchors (c) and Screws (b).