

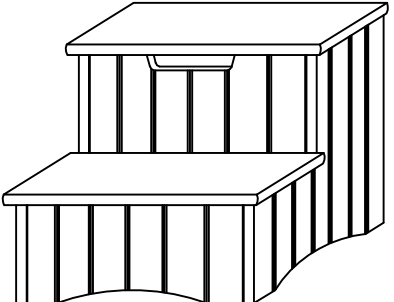

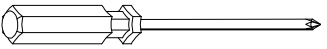

<b>Assembly Instruction</b> Style # 33W & 33CH	<b>Tools Required</b>	<b>Hardware Provided</b>
<p style="text-align: center;"><b>Storage step stool</b></p>  <p><b>It is recommended that this item should be assembled by two adults.</b></p>	 <p style="text-align: center;"><b>Phillips screwdriver</b></p>  <p>Note: Please don't over tighten the cam screws. Assure the cam screw fits in the plastic threaded insert. Otherwise, the cam nut might not be able to catch the cam screws.</p>	 <p><b>B1 15SETS-Camlocks</b></p>  <p><b>B2 2SETS-Hinges and screws</b></p>  <p><b>B3 1SET-Safety Hinge and screws</b></p>

### Furniture Parts

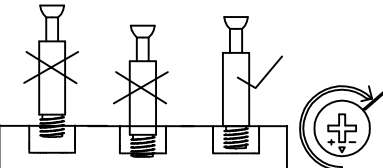

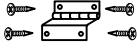
A1 1PC-Top panel

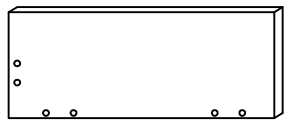
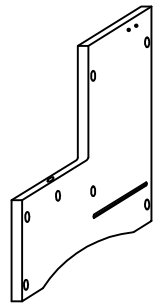

A2 1PCS-Side panels

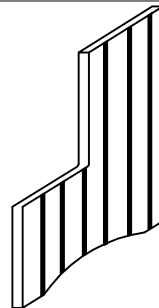

A3 1PCS-Side panels

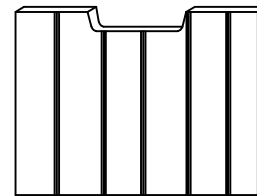

A4 1PC-Middle panel

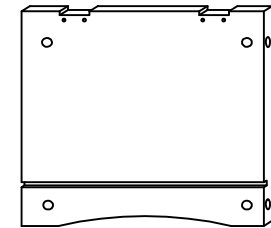

A5 1PC-Back panel

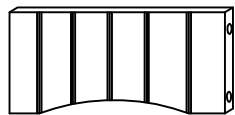

A6 1PC-Front panel



A7 1PC-Bottom panel



A8 1PC-Low Top Panel

### Step 1

Assemble the front panel A6, middle panel A4 and back panel A5 to the side panel A2 using camlocks B1.

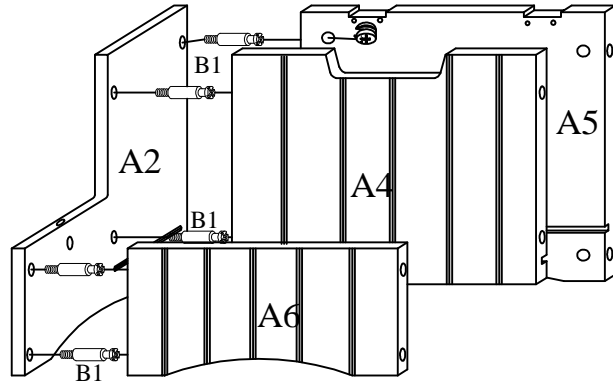

### Step 2

Insert the bottom panel A7 into the grooves of middle panel A4 and back panel A5.

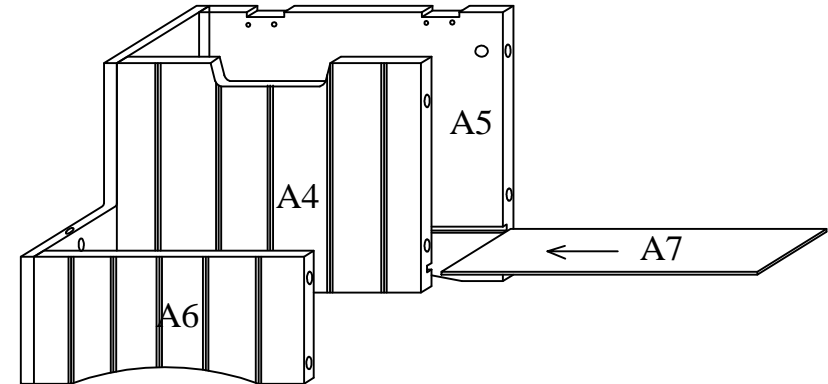

### Step 3

Assemble the side panel A3 to the front panel A6, the middle panel A4 and the back panel A5 using camlocks B1 .

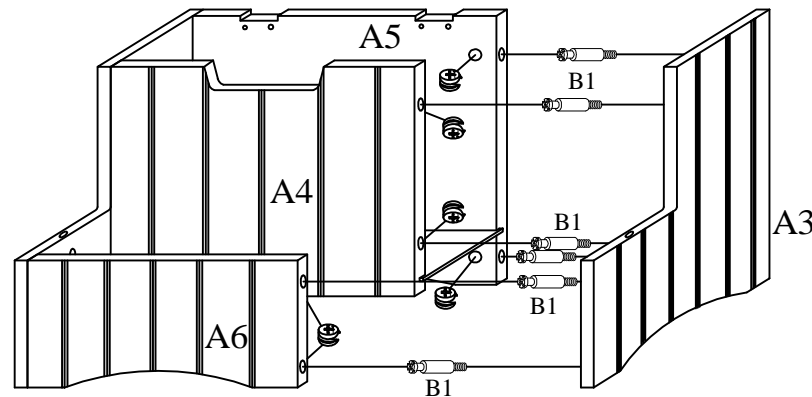

## Step 4

1. Assemble the low top panel A8 onto the side panels A2,A3 and front panel A6 using camlocks B1.
2. Attach the hinges B2 to the top of back panel A5.

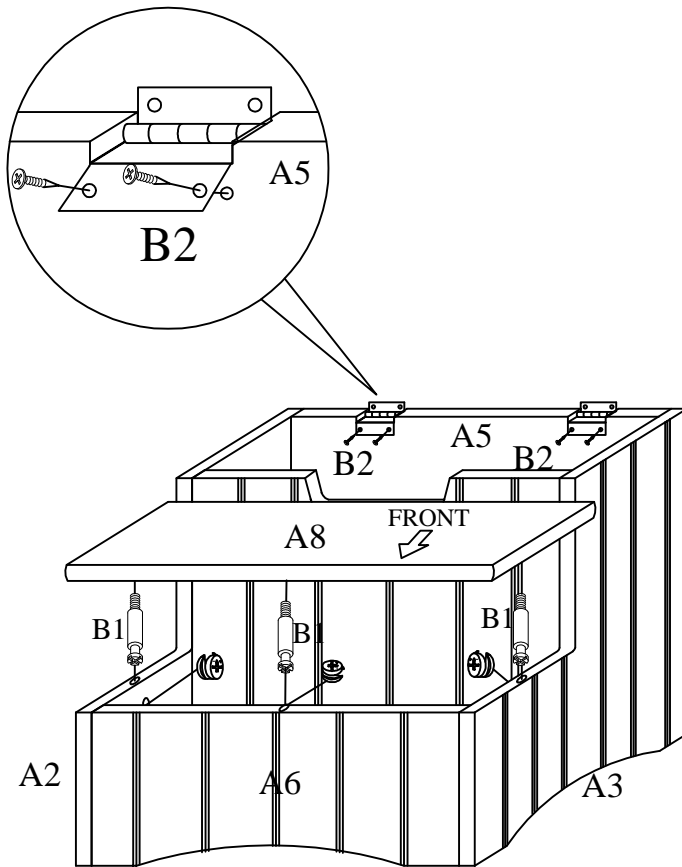

## Step 5

1. Connecting the top panel A1 to the back panel A5 using hinges B2.
2. Assemble the safety hinges B3 to the top panel A1 and the side panel A2.

Warning: The Maximum Load of the top panel is 200 lbs.

