

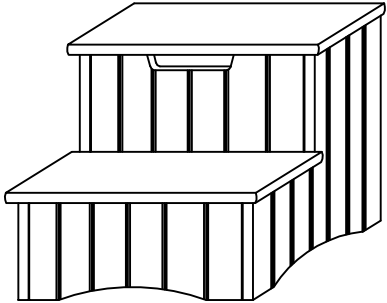

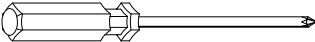



<p style="text-align: center;"><b>Assembly Instructions</b> Style # 31W &amp; 31M</p>	<p style="text-align: center;"><b>Tools Required</b></p>	<p style="text-align: center;"><b>Hardware Provided</b></p>
<p style="text-align: center;"><b>Storage step stool</b></p> 	 <p style="text-align: center;"><b>Phillips screwdriver</b></p> <p style="text-align: center;">Assembly:2 Adults are required to safely assemble this product.</p>	 <p>B1 15SETS-Camlocks</p>  <p>B2 2SETS-Hinges and screws</p>  <p>B3 1SET-Safety Hinge and screws</p>

**Furniture Parts**

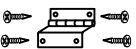
 <p>A1 1PC-Top panel</p>	 <p>A2 1PCS-Side panels</p>	 <p>A3 1PCS-Side panels</p>	 <p>A4 1PC-Middle panel</p>	 <p>A5 1PC-Back panel</p>
 <p>A6 1PC-Front panel</p>	 <p>A7 1PC-Bottom panel</p>	 <p>A8 1PC-Low Top</p>		

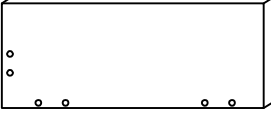
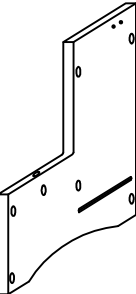
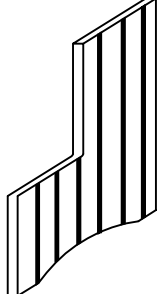
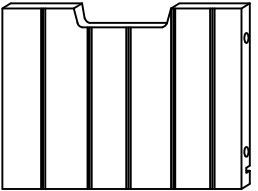
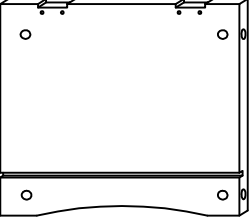
## Step 1

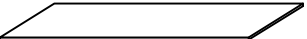
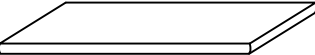
Assemble the front panel A6, the middle panel A4 and the back panel A5 to the side panel A2 using camlocks B1.

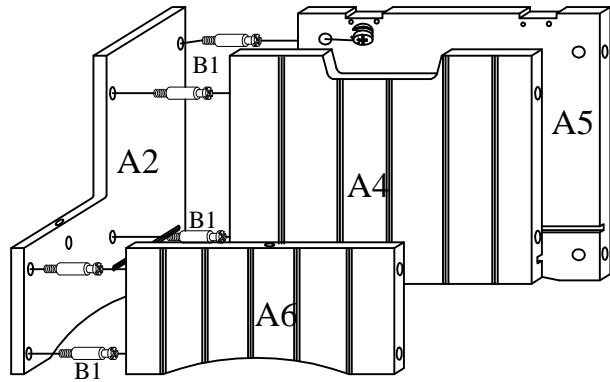

## Step 2

Insert the bottom panel A7 into the grooves of middle panel A4 and back panel A5.

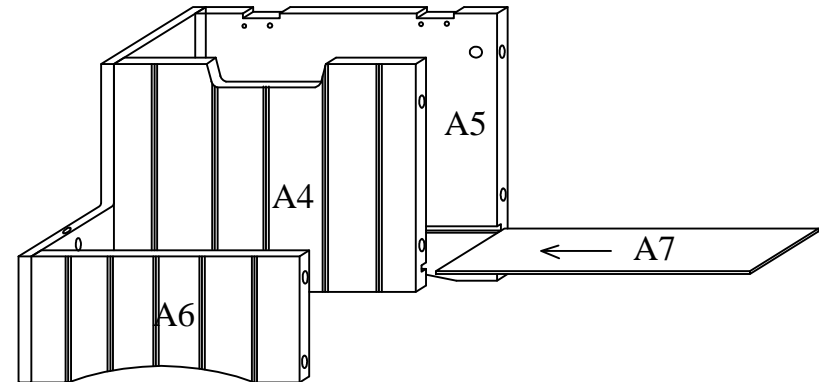

## Step 3

Assemble the side panel A3 to the front panel A6, the middle panel A4 and the back panel A5 using camlocks B1 .

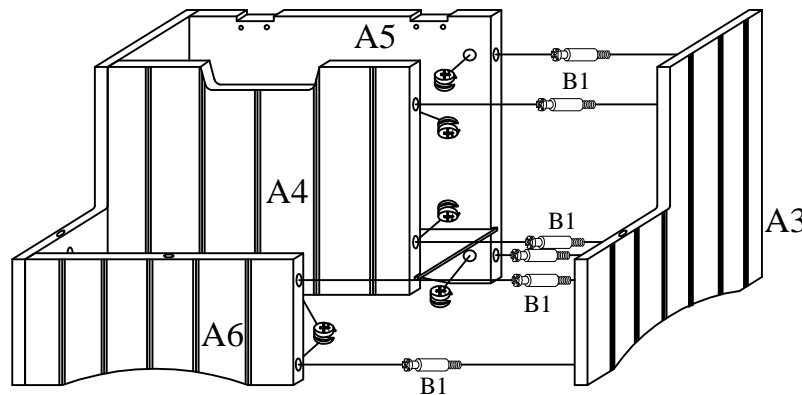

## Step 4

1. Assemble the low top A8 onto the side panels A2,A3 and front panel A6 using camlocks B1.
2. Attach the hinges B2 to the top of back panel A5.

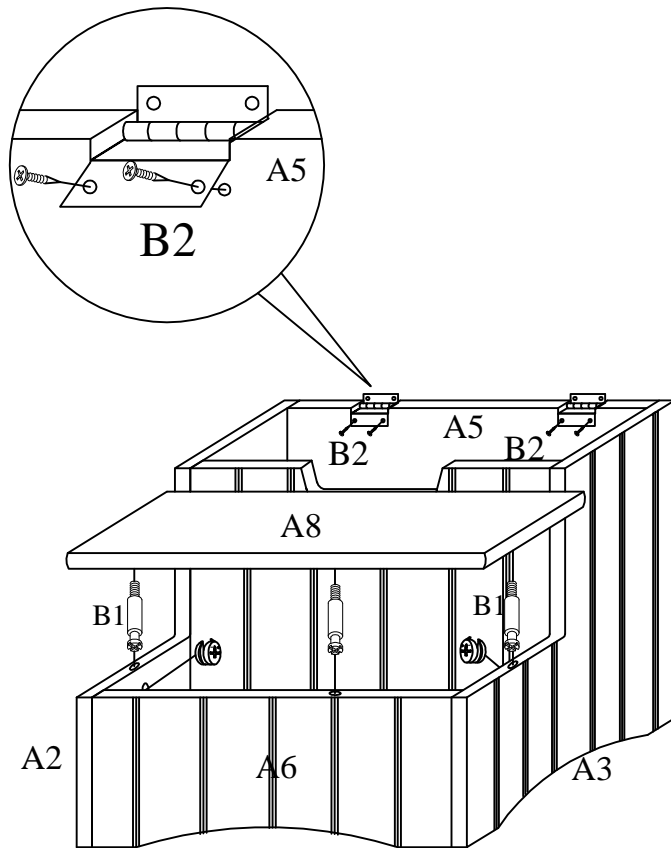

## Step 5

1. Connecting the top panel A1 to the back panel A5 using hinges B2.
2. Assemble the safety hinge B3 to the top panel A1 and the side panel A2.

Warning: The Maximum Load of the top panel is 200lbs.

