

# ASSEMBLY INSTRUCTIONS

Style # 2053BL-L Love Seat

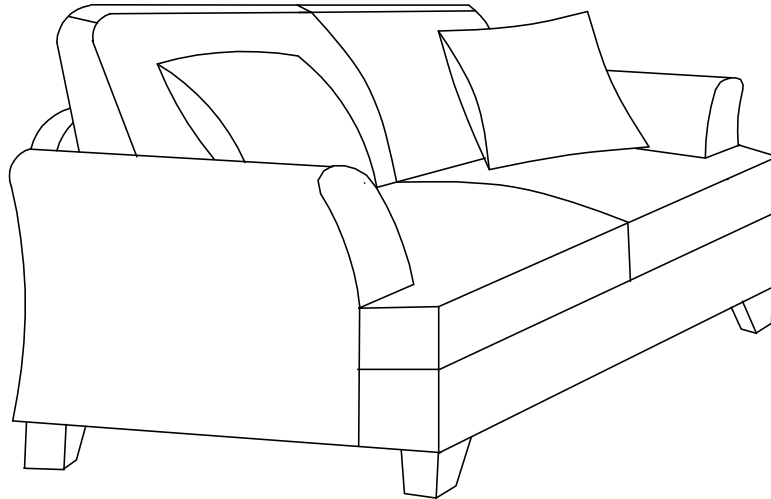

It is recommended that this item should be assembled by two adults

## Parts List :

A: Seat

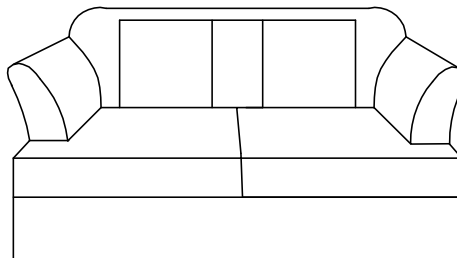

1PC

B-R: Backrest

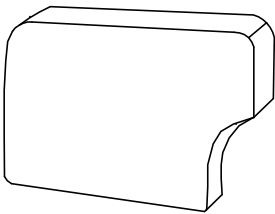

1PC

B-L: Backrest

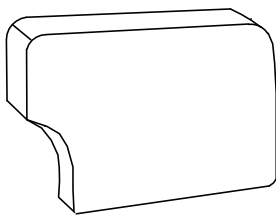

1PC

C: Pillow

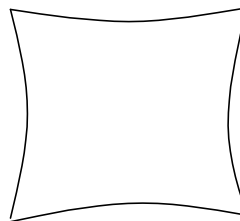

2PCS

D: Support Leg



1PC

## Hardware List :

E: Leg

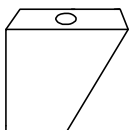

4PCS

F: Flat Washer

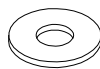

4PCS

G: Bolt

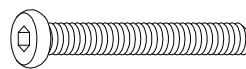

4PCS

H: Allen Wrench



1PC

Step 1: Attach Legs E to the bottom of Seat A using Flat Washers F and Bolts G.  
Then screw Support Leg D into the bottom of Seat A.

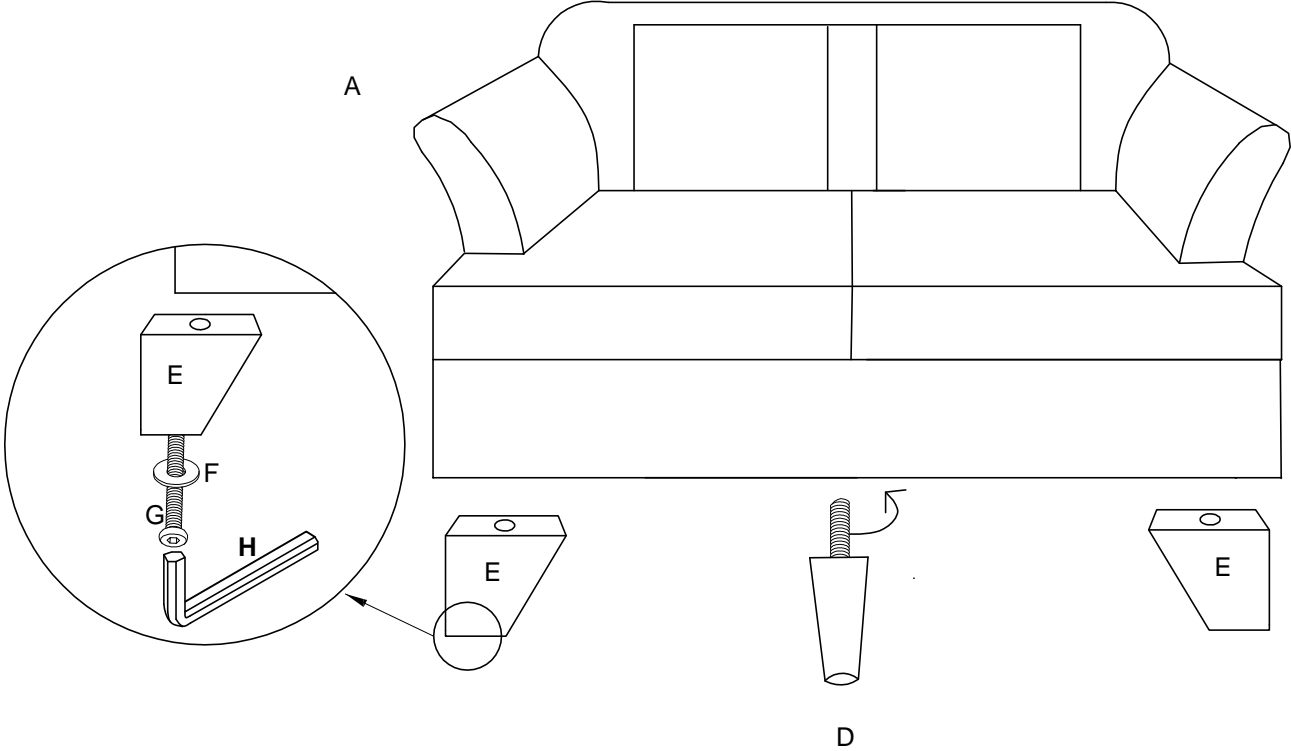

Step 2: Attach Backrests B to Seat A.

