

ASSEMBLY INSTRUCTIONS

Style # 1418 Towel Rack

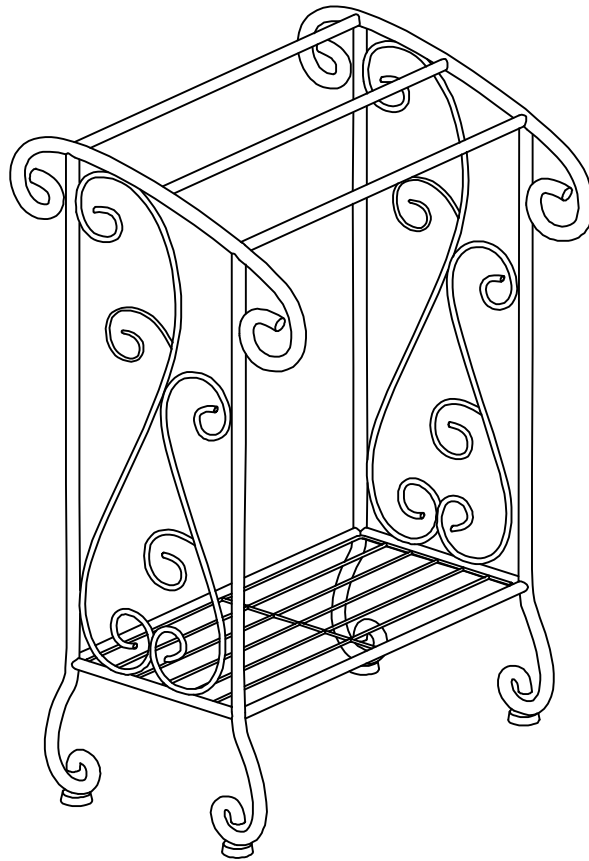

NOTE TO CUSTOMERS:

- For ease and speed of assembly we recommend that before you commence each step of the assembly that you identify all the parts required to complete that step.
- We recommend that where possible you allow sufficient space to assemble the item as close as possible to the place where it will be once assembled.
- For the protection of your furniture we recommend that the product is placed on protected surfaces during assembly to prevent any damage.
- During assembly do not over tighten, as this may damage the product.
- Please ensure you retain all the product packaging until the item completely assembled.
- Please periodically check all fittings and re-tighten as necessary.
- Please never allow any liquids to remain on your furniture as absorption can cause the wood to warp or finish to de-laminate.
- It is recommended that this item should be assembled by two adults.

Part List

Hardware List

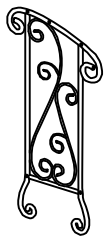

A: 1PC

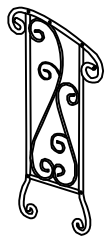

B: 1PC



C: 1PC

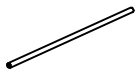

D: 3PCS



a: 10PCS



b: 4PCS

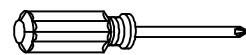

(NOT INCLUDED)

STEP 1

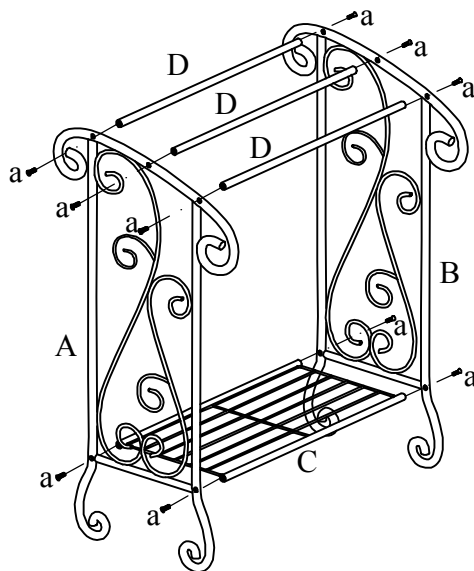

Please do not tighten Bolts (a) until all of them are attached.

STEP 2

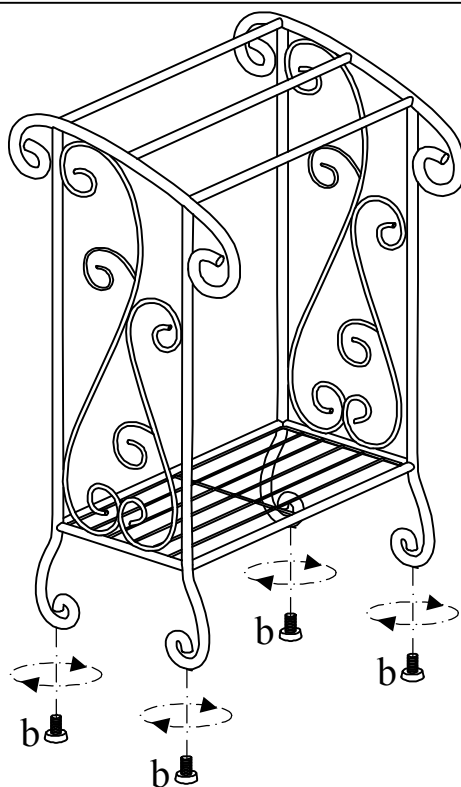

Tighten Adjustable Levelers (b) to the bottom of Side Frames (A) & (B).
Note: Please adjust Levelers (b) if this unit is not stable.